

RELAYS CATALOG

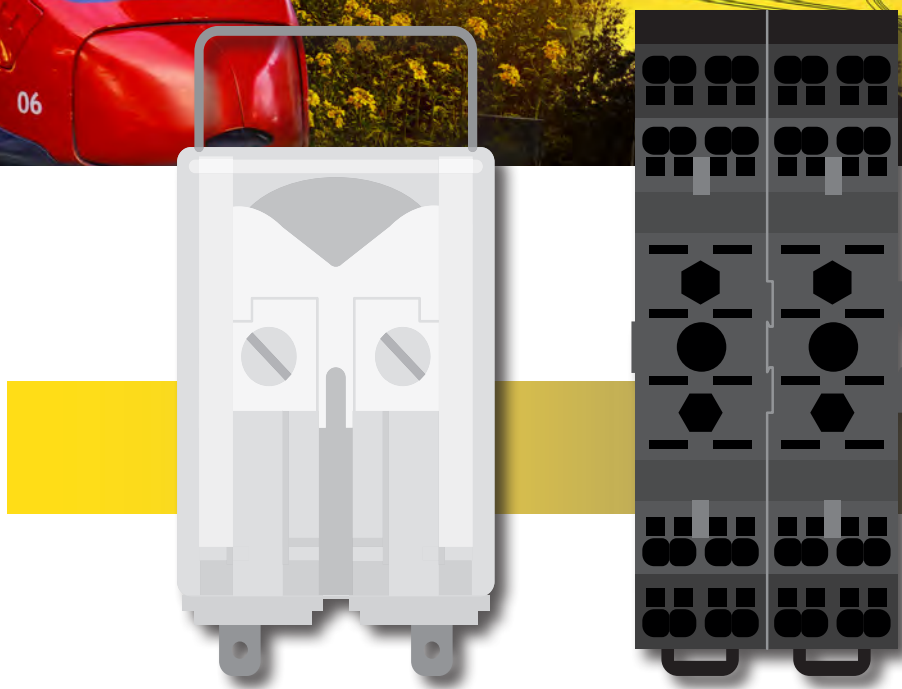



MANUFACTURING
RELAYS SINCE **1960**

OVER **200**
REFERENCES

MORE THAN **20** YEARS
OF K3 QUALIFICATION

3 FACTORIES
manufacture and
assemble the spare
parts for our relays

COMPLIANCE WITH SEVERAL
TENS OF STANDARDS
and customer specifications
in the rail, nuclear, power
generation and transmission,
and naval sectors

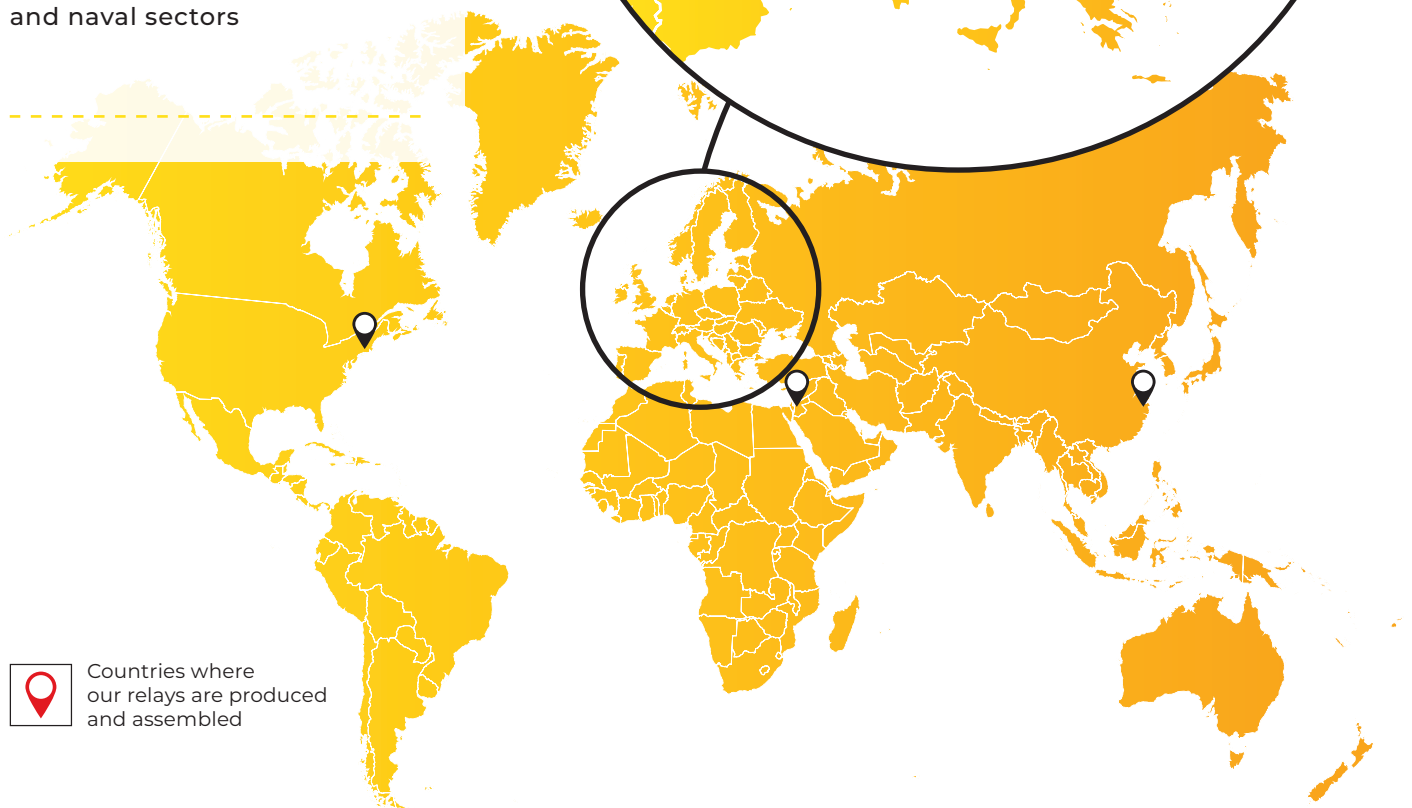
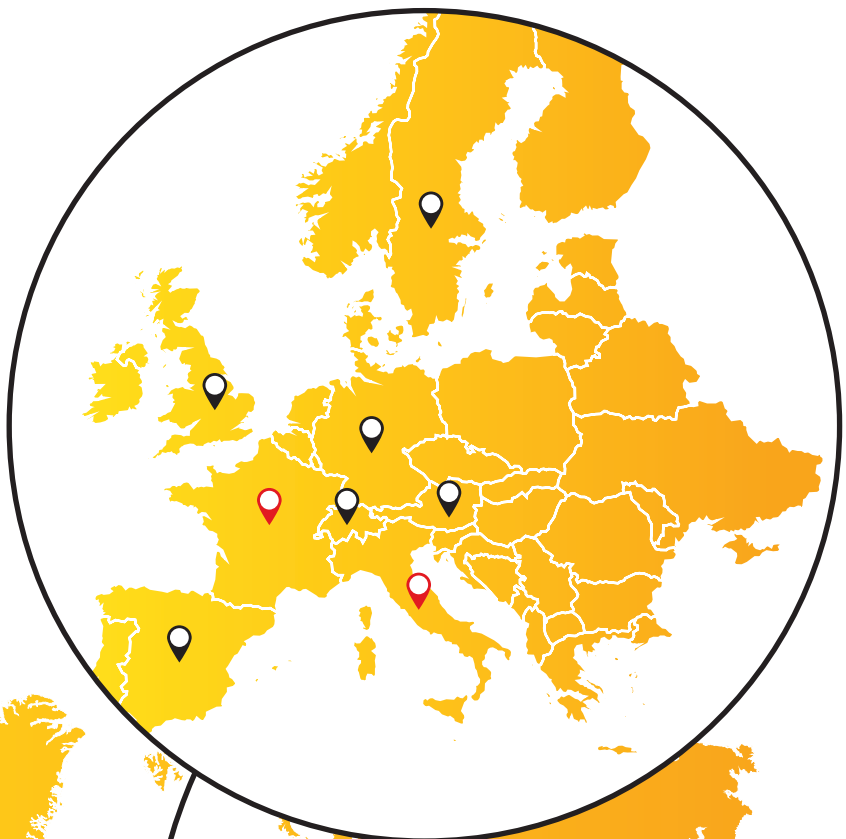

Countries where
our relays are produced
and assembled

THE COMPANY	P. 4
APPLICATIONS	P. 6
MAIN FEATURES OF OUR RELAYS	P. 8
OUR SELECTION GUIDE (+ INFO ABOUT OUR OPTIONS)	P. 10
RELAYS	P. 18
MONOSTABLE INSTANTANEOUS RELAYS	P. 20
MONOSTABLE INSTANTANEOUS RELAYS WITH FORCIBLY GUIDED CONTACTS	P. 62
BISTABLE RELAYS	P. 82
FAST-ACTING MONOSTABLE AND BISTABLE RELAYS	P. 102
RELAYS WITH TIME DELAY ON PICK-UP OR DROP-OUT (LOGICAL FUNCTION)	P. 128
TIMED RELAYS WITH FORCIBLY GUIDED CONTACTS	P. 176
MEASURING RELAY	P. 184
SOCKETS	P. 190
EXPLANATIONS CONCERNING SOCKET NUMBERING	P. 192
SOCKETS WITH FRONT CONNECTION	P. 194
SOCKETS WITH FRONT CONNECTION / SPRING CLAMP TERMINALS	P. 194
SOCKETS WITH FRONT CONNECTION / SCREW TERMINALS	P. 196
SOCKETS WITH SINGLE FASTON FRONT CONNECTION	P. 205
SOCKETS WITH REAR CONNECTION	P. 206
SOCKETS WITH REAR CONNECTION / SPRING CLAMP TERMINALS	P. 206
SOCKETS WITH REAR CONNECTION / SCREW TERMINALS	P. 210
SOCKETS WITH SINGLE FASTON REAR CONNECTION	P. 217
SOCKETS WITH DOUBLE FASTON REAR CONNECTION	P. 218
SOCKETS WITH REAR BLADE CONNECTION	P. 226
SOCKETS WITH REAR DOUBLE BLADE CONNECTION	P. 227
MOUNTING ON PCB	P. 228
RETAINING CLIPS	P. 231
KEYING PINS	P. 235
INSTALLATION, OPERATION AND MAINTENANCE	P. 238

MONOSTABLE INSTANTANEOUS
INSTANTANEOUS MONOSTABLE WITH FORCIBLY GUIDED CONTACTS
BISTABLE
FAST-ACTING (MONOSTABLE AND BISTABLE)
TIME DELAY (ON PICKUP OR DROP-OUT)
TIME DELAY WITH FORCIBLY GUIDED CONTACTS
MEASUREMENT
SOCKET NUMBERING EXPLANATIONS
FRONT CONNECTION
BACK CONNECTION
PCB MOUNT
RETAINING CLIPS
KEYING

NEW CHAUVIN ARNOUX GROUP HEADQUARTERS

12-16 RUE SARAH BERNHARDT
92600 - ASNIÈRES-SUR-SEINE
FRANCE

SINCE **1893**

128 YEARS
OF REFERENCES

FRENCH
MEASURING INSTRUMENT
DESIGNERS AND
MANUFACTURERS



PRESENT
IN MORE
THAN **10**
COUNTRIES



**MADE
IN FRANCE**

THE CHAUVIN ARNOUX GROUP: 128 YEARS OF REFERENCES

The French Chauvin Arnoux Group has been designing and manufacturing measuring instruments since 1893 and is acknowledged as a major player in the electrical sector. Its position on the physical measurements market in France and internationally is consolidated by its subsidiaries present in 10 countries and its distributor partners. The Group has its own R&D teams, technical centers and production sites, allowing complete mastery of the manufacturing chain for a result synonymous with quality and made in France.

CHAUVIN ARNOUX ENERGY: METERING, TESTING AND SUPERVISION

At the heart of the electrical measurement professions, Chauvin Arnoux Energy plays a crucial role in the implementation of energy management and control systems. Part of the Group since 1998, CA Energy covers specific requirements in the nuclear, T&D, naval and railway sectors:

- PLCs and safety-critical relays in cutting-edge industries
- Electrical network supervision, from power generation through to distribution
- Power supply quality.

Developing energy for your needs!

EXPECOISE BASED ON LONG EXPERIENCE

Within the Group, Chauvin Arnoux Energy offers the actors in energy and naval applications fixed electrical switchboard equipment for measuring, checking and monitoring the power distribution chain. For more than sixty years, the Group has been proposing its expertise in automation relays for harsh environments: nuclear, electricity transmission and distribution, and railways. It also draws on the expertise and know-how of its Italian subsidiary, AMRA Spa, which has been manufacturing electromechanical relays since 1975. The integration of relays from RIA - MTI, a well-known manufacturer since 1957, now makes Chauvin Arnoux Energy a major player in the world of automation relays.

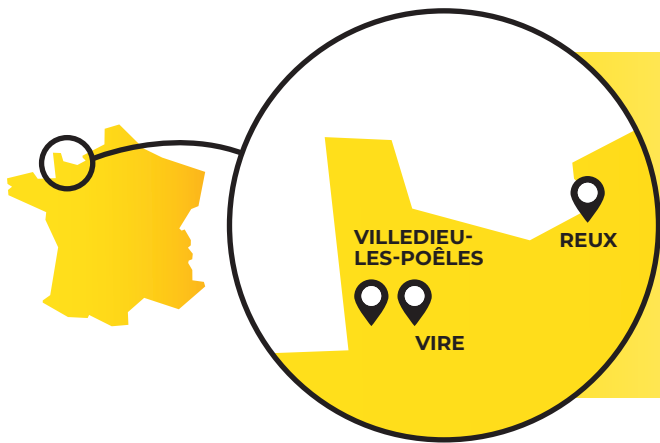

OUR PRODUCTION SITES AND INNOVATION CENTER

For Chauvin Arnoux, the choice to manufacture in France remains obvious. We thus benefit from guaranteed quality and traceability because we are “made in France”. Our mastery of the production process enables us to monitor the products and solutions under the Chauvin Arnoux brand.

VILLEDIEU-LES-POÊLES (FRANCE)

More than a hundred people working spread across 4000 square meters devoted mainly to electronics manufacturing. This is where we make single-and double-sided, flexible and rigid printed circuit boards up to Class V. In this way, 800,000 components can be assembled every week for CA Energy and the Group’s other brands.



VIRE (FRANCE)

Vire is the site where our current sensors are assembled. Two main buildings of 4,300 and 1,400 square meters house 140 people manufacturing our spare parts. The larger building produces the mechanical parts for our measuring instruments: turned, machined, milled and cut parts, as well as the shielding and casings made of sheet metal. The second building is dedicated to plastic injection for molding the casings of our products.

REUX (FRANCE)

10,000 square meters of buildings housing the Group’s logistics; the warehouses for storing the parts, the assembly workshops, the finished product stores and the shipping depaCOment. More than 60,000 references are managed in these warehouses which group the parts needed to manufacture the measuring instruments assembled on the site and the finished products ready for shipment all over the world.

The site is equipped with a single platform from which the instruments from the Group’s different brands are shipped to France, the subsidiaries and the international markets.



Our Italian subsidiary **AMRA’s** site at Macherio, near Milan, manufactures and assembles a wide range of relays, from standard models to highly specific products. This range is designed for applications in railway rolling stock and electricity generation and transmission in compliance with the standards in those sectors. Over the years, these relays have been approved and certified by all the main users in these different markets.

Marketed under the **CHAUVIN ARNOUX** brand, our products have become essential in the most demanding applications and sectors, mainly in electrical power generation, transmission and distribution, the petrochemical and mining industries, commercial shipbuilding and the rail industry (rolling stock and infrastructure). All these applications share a common requirement: continuity of service. A shutdown of the system may often cause serious inconvenience for the public and additional costs for the industrial company, as well as damaging its image. Working as a designer means choosing components whose reliability and durability are proven, with a high operational responsibility.

POWER GENERATION, TRANSMISSION AND DISTRIBUTION

- Protection, control and monitoring systems for HV distribution stations
- Protection, control and monitoring systems for electrical power generation stations
- Automation systems for turbines, alternators and transformers
- Monitoring and control systems for reservoirs, dams and valves/sluiques
- Trip relays



PETROCHEMICALS AND CHEMICALS INDUSTRIES, SHIPBUILDING, HEAVY INDUSTRY

- Protection, control and monitoring systems for power transformation and conversion
- Instrumentation desks and automation of manufacturing processes
- MV load centers
- Electrical switchboards in motor control centers (MCC)





Power generation



Nuclear



Power transmission



Rolling stock



Fixed railway installations



Shipbuilding



Petroleum industry



Heavy industry



Use the symbol of the application to identify the right product more easily.

ROLLING STOCK

- Door control
- Brake systems
- Safety loops
- Pantograph control
- Lighting and air-conditioning control
- Battery charge monitoring
- Traction systems
- Vehicle safe-running control systems (ECO, MS, SCMT, ATS, etc.)



POWER SYSTEMS, AC/DC CONVERSION AND ELECTRIC RAIL TRACTION

- Protection, control and monitoring systems for AC/DC conversion stations
- Line disconnect control panels
- Supervision of line voltage presence
- PPF power supply systems
- Trip relays
- Railway signaling power supply systems



- MONOSTABLE INSTANTANEOUS
- INSTANTANEOUS MONOSTABLE WITH FORCIBLY GUIDED CONTACTS
- BISTABLE
- FAST-ACTING (MONOSTABLE AND BISTABLE)
- TIME DELAY (ON PICKUP OR DROP-OUT)
- TIME DELAY WITH FORCIBLY GUIDED CONTACTS
- MEASUREMENT
- SOCKET NUMBERING EXPLANATIONS
- FRONT CONNECTION
- BACK CONNECTION
- PCB MOUNT
- RETAINING CLIPS
- KEYING

TYPES OF RELAYS

Electromechanical relays can offer several functions:

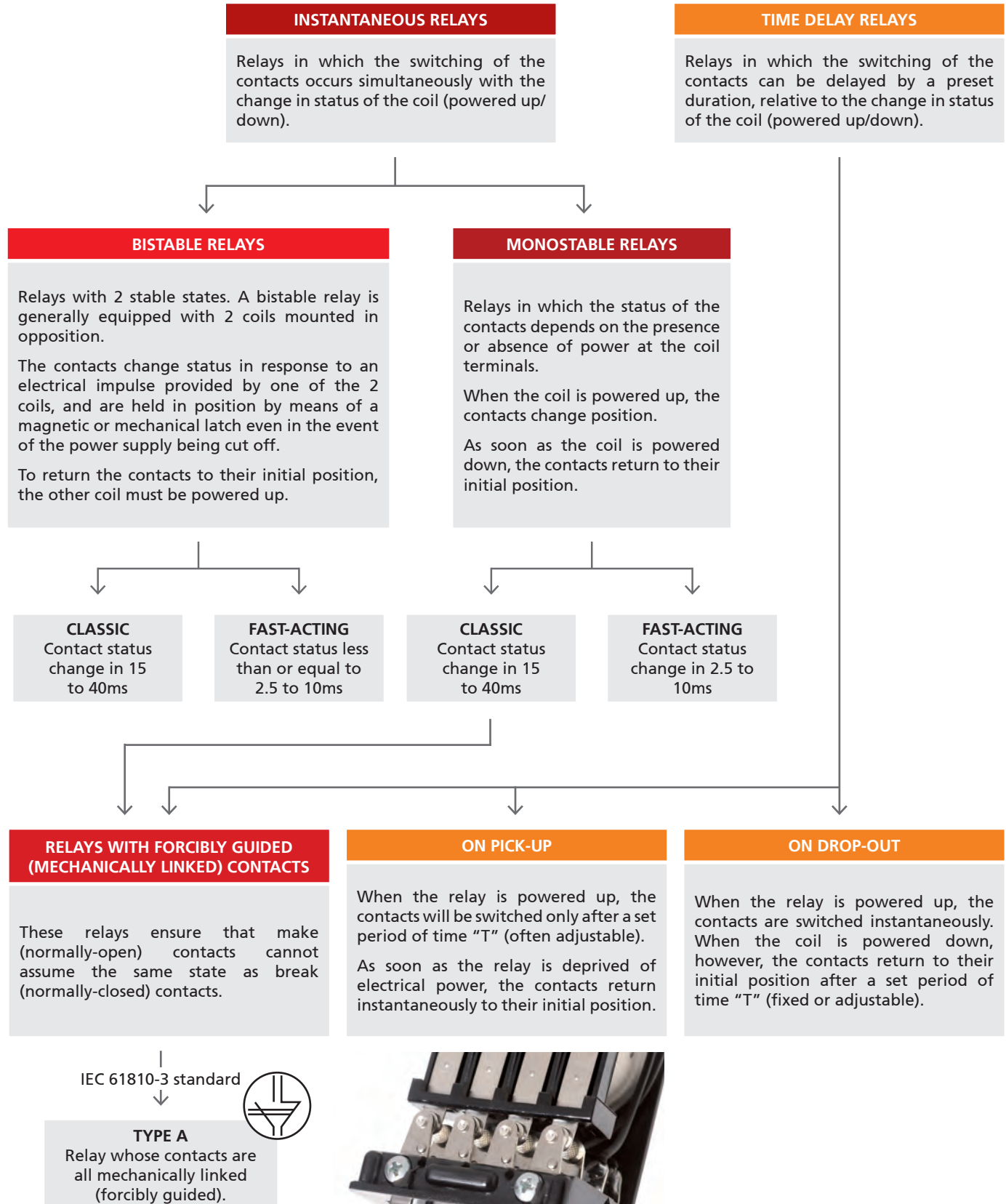

COIL SUPPLY VOLTAGE

The power supply used by relays is characterized by a number of factors, and principally:

NOMINAL VOLTAGE (Un): voltage value which is sufficient to actuate the contacts

OPERATING RANGE: the voltage range within which the relay functions correctly, expressed usually as a percentage of the nominal voltage

CONSUMPTION: power drawn by the relay during operation

DROP-OUT VOLTAGE: standard value (expressed as percentage of nominal voltage) defining the voltage at which drop-out/de-energization of the relay is certain to occur.

Some applications require particularly wide operating ranges, for example 0.7 to 1.25 Un in the case of electromechanical components used on rolling stock.

PROTECTION DEVICES

On a relay, when the power supply is discontinued, energy stored in the coil inductance creates an electromotive force contrary to that of the power supply. This stray voltage can reach values measured in thousands of volts. In this situation it is possible to install voltage suppression components, such as **DIODES FLYBACK**, **VARISTORS** or **TRANSIL DIODES**.

FLYBACK DIODE

The suppression component most widely adopted. This component provides a very low recirculation resistance for the energy accumulated at the terminals of the coil.

DIODE TRANSIL

UNIDIRECTIONAL TRANSILS

These block disturbances in one direction only, whereas in the presence of voltages with opposite polarity they respond as normal diodes.

BIDIRECTIONAL TRANSILS

These are installed in circuits where an alternating voltage is present; they consist of two Transil diodes connected in anti-series.

VARISTOR

A variable resistor (non-polarized), whose resistance value depends on the applied voltage.

MAIN FEATURES OF OUR RELAYS

CONTACT

TYPE

FORM C

This operates on the principle of **Break Before Make** (BBM). When the coil is energized, the COM (common) pole first breaks electrical continuity with the NC (normally closed) pole, then establishes electrical continuity with the NO (normally open) pole. Versions available with 2 to 20 contacts.

FORM D

This operates on the principle of **Make Before Break** (MBB).

SYMBOL DEFINITION



Normally open (Make)



Normally closed (Break)



Changeover (CO)

CONTACT LOAD

Depending on the type of load circuit to be broken, contacts can be specified with different materials or finishes, and mounted in conjunction with a magnetic blow-out function that helps to extinguish the electric arc generated by the electrical load to which the relay is connected. It is important to take note of the difference between the **nominal current** (range) of the contact and its **breaking capacity**:

- **NOMINAL CURRENT:** The current that can flow through a contact for an indefinite period of time without the contact suffering damage.
- **THE BREAKING CAPACITY:** Depending on its specific attributes, the relay can break high or low power loads. The breaking capacity, expressed in amperes, is the maximum level of current that can be broken by the particular relay under specific conditions.

By determining these parameters, it is possible to establish the electrical life expectancy of the contact/relay. The contacts of relays are subject to wear; depending on the type of use envisaged, the manufacturer indicates an electrical life expectancy and a mechanical life expectancy.

LIFE EXPECTANCY

ELECTRICAL

The number of successful operations that can be accomplished by a contact, breaking or making a given load circuit at a selected hourly frequency, with no impairment of its electrical characteristics.

MECHANICAL

The number of successful operations that can be accomplished by a contact under no-load conditions (no electrical load) at a selected hourly frequency, with no impairment of characteristics designed to ensure correct operation of the relay.

PROTECTION

MAGNETIC ARC BLOW-OUT

Permanent magnet allowing an electric arc to be extinguished more quickly, thus increasing the breaking capacity.

GOLD-PLATING OF THE CONTACTS

This has the effect of lowering surface resistance and enabling the conduction of lower currents than would be possible with an untreated contact.



POK relay with gold-plated contacts and terminals plus tropicalized coil.

APPLICATIONS

ENVIRONMENTAL AND OPERATING CONSTRAINTS

To ensure that you choose the right relay for a given application, any environmental constraint must first be interpreted correctly.

Depending on the application for which it has been chosen, any relay may be exposed to diverse environmental constraints which may prevent correct operation and accelerate its deterioration if it is incorrectly assessed. The following factors need to be taken into consideration for correct analysis:

OPERATING TEMPERATURE RANGE	The ambient temperature at which the relay is required to operate. In the event of conditions being variable, worst case minimum and maximum values must be considered.
RELATIVE HUMIDITY	Percentage value indicating the level of ambient humidity; for values higher than 75% and up to 95%, selection of a relay with tropicalized coil is advisable.

RAIL, TRAM, TROLLEY AND METRO

In the case of transport applications (rail, tram, and metro), consideration must be given to the regulations governing this sector, with specify more stringent operating constraints than those of standard product regulations.

Harmonized European and extra-European standards tend to regulate the following parameters.

RESISTANCE TO SHOCK AND VIBRATION	These can damage the component or cause contacts to open spontaneously.
REACTION TO FIRE	The specified requirements are intended to protect passengers and crew in the event of fire breaking out on board.
OPERATING RANGE	The operating range is wider than indicated normally for standard electromechanical components, as relays can also be battery-powered.
OPERATING TEMPERATURE	In rolling stock, the temperature range will usually be wider than the range indicated for industrial applications.

ELECTRICAL POWER GENERATION

Electricity generating stations are complex environments. The loads supervised by control systems often use DC voltages, so the relay contacts must be suitable for switching these loads.

Nuclear, thermoelectric, hydroelectric and wind power installations are also required to withstand heavy duty, non-stop operating conditions. They impose particularly stringent requirements in terms of guaranteeing continuity of service and long-term reliability. In the case of hydroelectric and wind power generating facilities located in places where access is difficult (mountains or offshore platforms), maintenance costs tend to be high.

Particular care must also be taken where there are significant variations in temperature and vibration for these applications.

K3 QUALIFICATION

Category K3 (seismic stresses) corresponds to EDF qualification for use of our products in nuclear power plants.

STEP 1

Electrical safety, functional and electromagnetic emissions tests

- Tests linked to electrical safety
- Functional tests
- Checking of electromagnetic emissions

STEP 2

Limit tests linked to the environment

- Electromagnetic disturbances
- Influence of temperature

STEP 3

Aging tests

- High temperature
- 2,000 hours

STEP 4

Seismic resistance tests

- Tremors

Scan the QR code to watch the video of our seismic tests



STEP 5















Technological validation tests

















- Growth of whiskers*

The team at Chauvin Arnoux Energy is always at customers' disposal to help them choose.

*tin filaments

DEPENDING ON PRODUCTS

 Power generation	 Nuclear	 Power transmission	 Rolling stock	 Fixed railway installation	 Shipbuilding	 Petroleum industry	 Heavy industry
	Depending on products		Depending on products				

Model	Monostable instantaneous	Bistable (latching)	Forcibly guided contacts	Fast-acting(*)	Time delay	Contacts	In	Notes	Rolling stock equipment (***)	Nuclear	Page
RCM	■					2 CO	10 A	Compact			22
RDM	■					4 CO	10 A	Compact			22
RGM	■					4 CO	12 A	High breaking capacity (**)			26
RMMX	■					8 CO	10 A	Multi-contact, compact			30
RMM	■					8-12-20 CO	12 A	High breaking capacity, multi-contact			34
POK-POKS	■					2 CO	5-10 A	Compact			38
BIPOK-BIPOKS	■					4 CO	5-10 A	Compact			38
TRIPOK-TRIPOKS	■					6 CO	5-10 A	Compact			38
QUADRIPOK	■					8 CO	10 A	Compact			38
ESAPOK	■					12 CO	10 A	Compact			44
OK	■					4-8-12 CO	10 A	High breaking capacity			44
OKB184	■					4 CO	10 A	High breaking capacity, K3-qualified			44
RE3000	■					4 CO	10 A	K3-qualified			54
FOKB	■					4 CO NC-NO	13 A	High breaking capacity, NF F62-002			58
RCG	■		■			2 CO	10 A	Forcibly guided contacts, type A, EN61810-3			64
RDG	■		■			4 CO	10 A	Forcibly guided contacts, type A, EN61810-3			64
RGG Previous name RGMZX	■		■			4 CO	10 A	High breaking capacity, forcibly guided contacts, type A, EN61810-3			70
RMGX	■		■			8 CO	10 A	High breaking capacity, forcibly guided contacts, type A, EN61810-3			76
RGB		■				3-4 CO	12 A	High breaking capacity			84
RMBX		■				7-8 CO	10 A	Multi-contact			88
RMB		■				7-11-19 CO	10 A	High breaking capacity, multi-contact, common negative			92
OKBA		■				4-8 CO	10 A	High breaking capacity			96
RGMVX	■			■		4 CO	10 A	Operating time < 8 ms			104
RMMV/X	■			■		8-12 CO	10 A	Operating time < 8 ms for compact models, otherwise < 10 ms			110
RGR	■			■		2 CO	2 A	Operating time < 3 ms			110

DEPENDING ON PRODUCTS

 Power generation	 Nuclear	 Power transmission	 Rolling stock	 Fixed railway installation	 Shipbuilding	 Petroleum industry	 Heavy industry
	Depending on products		Depending on products				

Model	Monostable instantaneous	Bistable (latching)	Forcibly guided contacts	Fast-acting(*)	Time delay	Contacts	In	Notes	Rolling stock equipment (***)	Nuclear	Page
RGMV	■			■		4 (CO or NC)	10 A	Operating time < 8 ms			110
RMMV	■			■		8 (CO or NC)	10 A	Operating time < 6 ms			110
RMMZ11/13	■			■		8 CO	10 A	Operating time < 13 ms			110
RGBV		■		■		4 CO	10 A	Operating time < 10 ms			114
RMBV		■		■		8-12 CO	10 A	Operating time < 10 ms			114
RGBZ10/11		■		■		3-4 CO	12 A	Operating time < 12 ms			120
RMBZ30		■		■		7 CO	10 A	Operating time < 18 ms			120
RV LV16	■			■		6 (NO or NC)	5 A	Operating time < 6 ms			124
RDT					■	4 CO	10 A	Time delay on pick-up or drop-out			130
RDL - RGL					■	2 CO	10 A	Flasher			136
RDTE15/16					■	4 CO	10 A	Delay on drop-out, adjustable duration, no Vaux			136
RGTO					■	1 CO	5 A	Delay on drop-out, adjustable duration, no Vaux			140
TMM					■	4 CO	10 A	Multifunction relay, 10 functions			148
TM - TMS Previous names OK-TMF/S					■	4 CO	5-10 A	Time delay on pick-up or drop-out			154
TOK					■	4 CO	10 A	High breaking capacity, time delay on pick-up or drop-out			160
OKR					■	4 CO	5 A	Time delay on pick-up or drop-out			160
OKT					■	4 CO	5 A	Time delay on pick-up or drop-out			166
UTM					■	-	-	Static time delay unit			170
TOK-L					■	4 CO	10 A	High breaking capacity, flasher			170
TOK-FP					■	4 CO	10 A	High breaking capacity, flasher			170
OKRE-L					■	4 CO	5 A	Flasher			170
OKRE-FP					■	4 CO	5 A	Flasher			170
CLE					■	4 CO	5 A	Flasher			170
RGK			■	■	■	4 CO	12 A	Forcibly guided contacts, type A, EN61810-3			178
MOK-V2	■					2 CO	3 A	Measuring relay, voltage			186

* Unless stated otherwise, operating times indicated in the catalog are understood as being inclusive of bounces

** Relays with contact specifications guaranteeing efficient break of strongly inductive DC loads, even with 220Vdc voltages

*** These relays comply with regulations applicable to rolling stock; also suitable for use in other applications.

SELECTION GUIDE

TERMINAL	FRONT Connection			REAR Connection			PCB
	SCREW		SPRING CLAMP	SCREW	DOUBLE FASTON	SPRING CLAMP	
MOUNTING	PLATE-WALL / DIN RAIL	PLATE-WALL	PLATE-WALL / DIN RAIL	FLUSH MOUNTING			SOLDER
 RELAY MODEL				 SOCKET MODEL			
RCM	PAVC081	-	PAIR085	PRVC081	PRDC081	-	PRCC080
RDM	PAVD161	-	PAIR165	PRVD161	-	-	PRCD161
RGM	PAVG161	-	-	PRVG161	PRDG161	-	-
RMMX	96IP20-I DIN	-	PAIR320	-	ADF4	PRIR320	-
RMM (8 cts)	PAVM321	-	-	PRVM321	PRDM321	-	-
RMM (12 cts)	PAVM481	-	-	PRVM481	PRDM481	-	-
RMM (20 cts)	PAVM801	-	-	PRVM801	PRDM801	-	-
POK-POKS	50IP20-I DIN	50L	PAIR080	53IL	ADF1	PRIR080	65
BIPOK-BIPOKS	48BIP20-I DIN	48BL	PAIR160	43IL	ADF2	PRIR160	65
TRIPOK-TRIPOKS	78BIP20-I DIN	78BL	PAIR240	73IL	ADF3	PRIR240	-
QUADRIPOK	96IP20	96BL	PAIR320	43IL	ADF4	PRIR320	65
ESAPOK	156IP20	78BL	PAIR480	73IL	ADF6	PRIR480	-
OK / OKB184	48BIP20-I DIN	48BL	PAIR160	43IL	ADF2	-	65
RE3000	EVV3100	EVL3100*	-	ERV3100	ERL320*	ERL310*	-
FOKB	-	-	-	-	84F*	-	-
RCG	50IP20-I DIN	-	PAIR080	-	ADF1	PRIR080	65
RDG	48BIP20-I DIN	-	PAIR160	-	ADF2-BIPOK	PRIR160	65
RGG	48BIP20-I DIN	-	PAIR160	43IL	ADF2	PRIR160	65
RMGX	96IP20-I DIN	-	PAIR320	-	ADF4-E1	PRIR321	-
RGB	PAVG161	-	-	PRVG161	PRDG161	-	-
RMBX	96IP20-I DIN	-	PAIR320	-	ADF4	PRIR320	-
RMB (7 cts)	PAVM321	-	-	PRVM321	PRDM321	-	-
RMB (11 cts)	PAVM481	-	-	PRVM481	PRDM481	-	-
RMB (19 cts)	PAVM801	-	-	PRVM801	PRDM801	-	-
OKBA	48BIP20-I DIN	48BL	PAIR160	43IL	ADF2	PRIR160	65
RGMVX	48BIP20-I DIN	-	PAIR160	-	ADF2	PRIR160	-
RMMVX	96IP20-I DIN	-	PAIR320	-	ADF4	PRIR320	-
RMMVx1/7	PAVM481	-	-	PRVM481	PRDM481	-	-

*EVL3100: Faston front connection

*ERL320: double blade

*ERL310: single blade

*84F: Single Faston

OLD SOCKET NAME	NEW SOCKET NAME
50	50IP20-I DIN
48B	48IP20-I DIN
78B	78IP20-I DIN
50BF	50L
48BF	48BL
78BF	78BL
65F	65

MONOSTABLE INSTANTANEOUS
 INSTANTANEOUS MONOSTABLE WITH FORCIBLY GUIDED CONTACTS
 BISTABLE
 FAST-ACTING (MONOSTABLE AND BISTABLE)
 TIME DELAY (ON PICKUP OR DROP-OUT)
 TIME DELAY WITH FORCIBLY GUIDED CONTACTS
 MEASUREMENT
 SOCKET NUMBERING EXPLANATIONS
 FRONT CONNECTION
 BACK CONNECTION
 PCB MOUNT
 RETAINING CLIPS
 KEYING

TERMINAL	FRONT Connection			REAR Connection			PCB
	SCREW		SPRING CLAMP	SCREW	DOUBLE FASTON	SPRING CLAMP	
MOUNTING	PLATE-WALL / DIN RAIL	PLATE-WALL	PLATE-WALL / DIN RAIL	FLUSH MOUNTING			SOLDER
 RELAY MODEL	 SOCKET MODEL						
RGBV	48BIP20-I DIN	-	PAIR160		ADF2	PRIR160	-
RMBV	96IP20-I DIN	-	PAIR320	-	ADF4	PRIR320	-
RMBVx5/6	PAVM481	-	-	PRVM481	PRDM481	-	-
RGR	PAVG161	-	-	PRVG161	PRDG161	-	-
RGMV	PAVG161	-	-	PRVG161	PRDG161	-	-
RMMV	PAVM321	-	-	PRVM321	PRDM321	-	-
RMMZ11 / 13	PAVM321	-	-	PRVM321	PRDM321	-	-
RGBZ10 / 11	PAVG161	-	-	PRVG161	PRDG161	-	-
RMBZ30	PAVM321	-	-	PRVM321	PRDM321	-	-
RV LV16	78BIP20-I DIN	-	PAIR240	73IL	ADF3	PRIR240	-
RDT	PAVD161	-	PAIR165	PRVD161	-	-	PRCD161
RDL	PAVD161	-	PAIR165	PRVD161	-	-	PRCD161
RGL	PAVG161	-	-	PRVG161	PRDG161	-	-
RDTE15 / 16	PAVD161	-	PAIR165	PRVD161	-	-	PRCD161
RGTO	PAVG161	-	-	PRVG161	PRDG161	-	-
TMM	48BIP20-I DIN	48BL	PAIR160	43IL	ADF2	PRIR160	65
TM - TMS	48BIP20-I DIN	48BL	PAIR160	43IL	ADF2	PRIR160	65
TOK	48BIP20-I DIN	48BL	PAIR160	43IL	ADF2	PRIR160	65
OKR	48BIP20-I DIN	48BL	PAIR160	43IL	ADF2	PRIR160	65
OKT	48BIP20-I DIN	48BL	PAIR160	43IL	ADF2	PRIR160	65
UTM	48BIP20-I DIN	48BL	PAIR160	43IL	ADF2	PRIR160	65
TOK-L	48BIP20-I DIN	48BL	PAIR160	43IL	ADF2	PRIR160	65
TOK-FP	48BIP20-I DIN	48BL	PAIR160	43IL	ADF2	PRIR160	65
OKRE-L	48BIP20-I DIN	48BL	PAIR160	43IL	ADF2	PRIR160	65
OKRE-FP	48BIP20-I DIN	48BL	PAIR160	43IL	ADF2	PRIR160	65
CLE	48BIP20-I DIN	48BL	PAIR160	43IL	ADF2	PRIR160	65
RGK	48BIP20-I DIN	-	PAIR160	-	ADF2	PRIR160	-
MOK-V2	48BIP20-I DIN	48BL	PAIR160	43IL	ADF2	PRIR160	65

For more details, please see the socket datasheets.



ORDERING SCHEME

The product code is obtainable from the "Ordering scheme" table indicated in the data sheets for each product.

Codes to order									
Model	Number of CO contacts	1 Product code	2 Application ⁽¹⁾	3 Configuration A	4 Configuration B	Label	5 Type of input supply	6 Nominal voltage (V) ⁽²⁾	7 Keying position ⁽³⁾ / option
POK	2 - 5A	POK	E: Energy / Railway fixed equipment R: Railway rolling stock	1: Standard	0: Standard	F	C: Vdc A: Vac 50 Hz H: Vac 60 Hz	012 - 024 - 036 048 - 072 - 096 100 - 110 - 125 127 - 132 - 144 220 - 230	XXX CS = PCB-mount version L = Low temperature
POKS	2 - 10A	POKS		2: Diode //	2: P2				
BIPOK	4 - 5A	BPOK		3: Varistor	4: P4 GEO				
BIPOKS	4 - 10A	BPOKS		4: LED	5: P5 GEO				
TRIPOK	6 - 5A	TPOK		5: Diode // + LED	6: P6 GEO				
TRIPOKS	6 - 10A	TPOKS		6: Varistor + LED	7: P7				
QUADRIPOKS	8 - 10A	QPOK		7: Transil	8: P8				
ESAPOKS	12 - 10A	EPOK		8: Transil + LED					

Example

BPOKS	R	5	8	F	C	024	
BPOKS R58F-C024 - BIPOKS relay, ROLLING STOCK series, nominal voltage 24 Vdc, with diode, LED and P8 finish (gold-plated contacts)							

1 PRODUCT CODE	Relay model. This field may correspond exactly to the name of the model (e.g. POKS) or may be an abbreviation of the name (e.g. QPOK = QUADRIPOK).
2 APPLICATION	<p>Sector in which the relay is used. Depending on the sector and application, relays may need to have different finish specifications and to meet special constructional constraints.</p> <p>E Series: Energy/Railway fixed equipment These relays are suitable for use in sectors such as electrical power generation, transmission and distribution, petrochemicals, shipbuilding and heavy industries in general, as well as railway fixed equipment.</p> <p>R Series: Railway rolling stock Relays suitable for use on rolling stock, particularly for railway applications, trams, trolleybuses and metros. "R" relays comply with the requirements of the standards in this sector.</p>
3 CONFIGURATION A	Available versions and options
4 CONFIGURATION B	Available versions and options
5 TYPE OF INPUT SUPPLY	DC voltage, 50 Hz AC voltage, 60 Hz AC voltage, DC + AC voltage.
6 NOMINAL VOLTAGE	Voltage rating of the relay
7 KEYING POSITION/ OPTION	<p>Field used to indicate the possible inclusion of a keying position and/or other options.</p> <ul style="list-style-type: none"> Keying position PCB-mount model (code CS) "R" application (Railway, rolling stock): depending on the model of the relay, coils may be available with operating ranges different to those indicated in EN60077 standard (0.75... 1.25 Un). Consult the data sheets of the single products for more details. <p>Example of code for ordering a special operating range = Z01, Z02, Z03, etc.</p> <ul style="list-style-type: none"> Options (low temperature, manual operating lever, etc.)



OPTIONS

Depending on the product line, there is a wide range of options available.

OPTION	DESCRIPTION
P2 / TROPICALIZATION	Tropicalization of coil with epoxy resin for exposure to 95% RH (@ T 50 °C). This treatment also protects the coil against corrosion that could occur through the combination of humidity and certain chemical agents, such as those found in acid atmospheres (typical of geothermal power stations) or saline atmospheres.
P4GEO / GOLD PLATING	Gold plating of contacts with gold-nickel alloy, thickness $\geq 6\mu$, on nickel. This treatment ensures long-term capacity of the contact to conduct lower currents in harsh ambient conditions such as acid atmospheres (typical of geothermal power stations) or saline atmospheres.
P5GEO	P4GEO gold-plating of contacts + P2 coil tropicalization.
P6GEO	P4GEO type gold-plating, but applied to contacts, contact terminals and output terminals + P2 coil tropicalization.
P7	AgCdO (silver cadmium oxide) contacts.
P8	Gold plating of contacts with gold-cobalt alloy, thickness $\geq 5\mu$, knurled fixed contact. This finish allows further improvement of the performance provided by gold-plated contact, compared with P4GEO treatment..
LED	LED indicator showing presence of power supply, wired in parallel with the coil.
FLYBACK DIODE	Polarized component connected in parallel to the coil (type 1N4007 or BYW56 for the rolling stock version) designed to attenuate the overvoltages generated by the coil when the contacts are opened.
VARISTOR	Non-polarized component connected in parallel with the coil, designed to suppress overvoltages higher than the clamping voltage, generated by the coil when de-energized.
TRANSIL	Non-polarized component connected in parallel with the coil. Behavior is similar to that of a varistor, with faster operating times.
LOW TEMPERATURE	Minimum operating temperature -50 °C, only for rolling stock version (option "L").
C.S.	PCB-mount version (for POK-POKS-BIPOK-BIPOKS relays only).
LEVER FOR MANUAL OPERATIONS	Allows manual operation of the relay, with the cover closed, using a screwdriver.

RELAYS

RELAYS

RELAYS

RELAYS

RELAYS

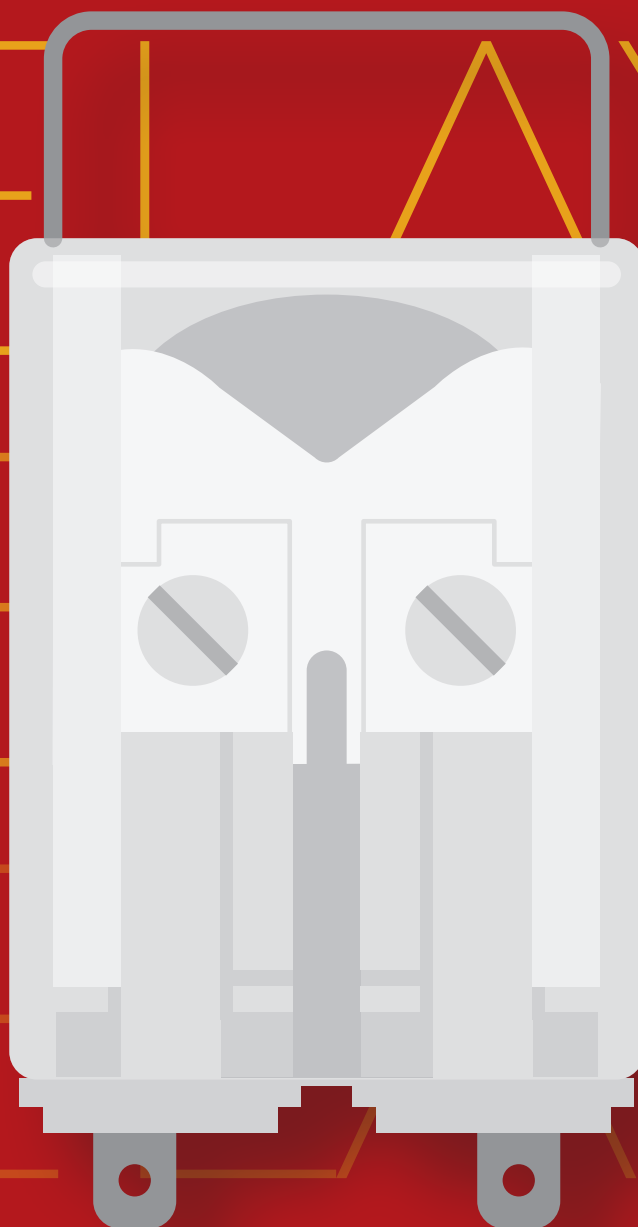

RELAYS

INSTANTANEOUS MONOSTABLE RELAYS.....	P. 20
MONOSTABLE RELAYS WITH FORCIBLY GUIDED CONTACTS	P. 62
BISTABLE RELAYS	P. 82
FAST-ACTING RELAYS (MONOSTABLE AND BISTABLE).....	P. 102
TIME DELAY RELAYS (ON PICK-UP OR ON DROP-OUT), LOGIC FUNCTION	P. 128
TIME DELAY RELAYS WITH FORCIBLY GUIDED CONTACTS	P. 176
MEASURING RELAYS	P. 184

RELAYS

RELAYS

RELAYS

RELAYS

RELAYS

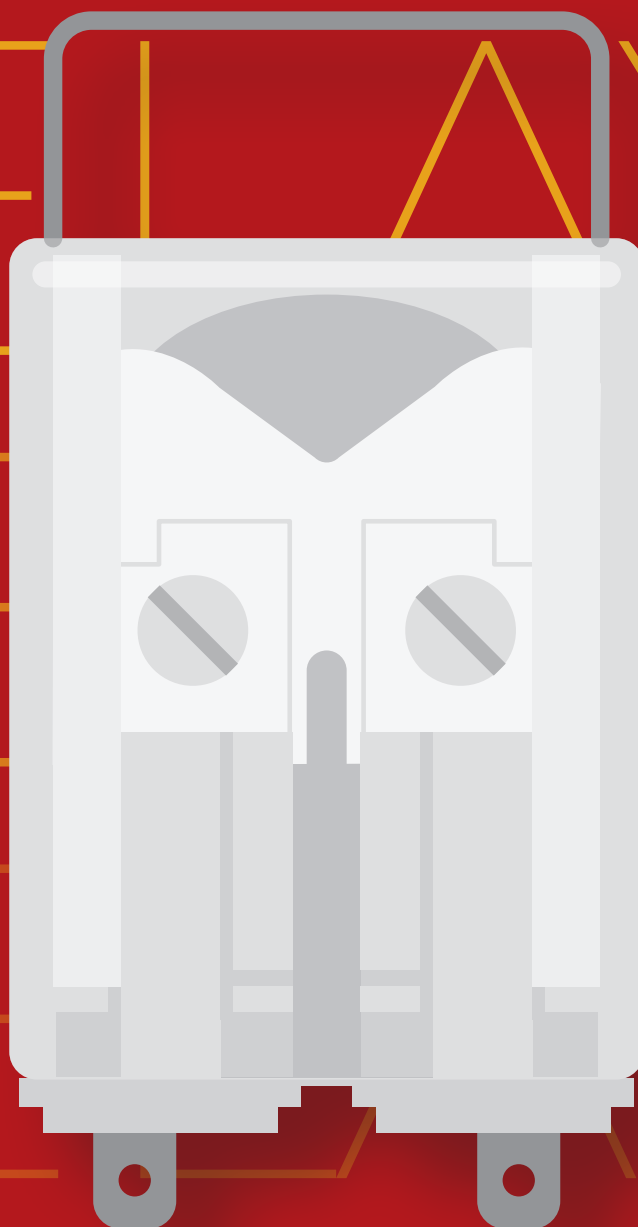

INSTANTANEOUS MONOSTABLE RELAYS



RELAYS

INSTANTANEOUS MONOSTABLE RELAYS WITH 2-4 CONTACTS

RCM | RDM SERIES

USER SECTORS



Power generation



Nuclear



Power transmission



Rolling stock



Fixed railway installations



Shipbuilding



Petroleum industry



Heavy industry



RCME



RDME

PRODUCT ADVANTAGES

- Compact plug-in instantaneous monostable relays
- High performance, compact dimensions
- Self-cleaning knurled contacts
- Magnetic arc blow-out for higher breaking capacity
- Fitted with mechanical optical contact status indicator as standard
- Relay coupled automatically to socket, with no need for a retaining clip
- Operation using DC or AC power supply (directly, without rectifiers or diodes)
- Wide variety of configurations and customizations
- Also available in current-monitoring version
- Also available in PCB-mount version
- Transparent cover, pull-out handle
- Label holder in cover for customer's use
- Positive mechanical keying for relay and socket

DESCRIPTION

The **C and D series** are made up of 2 basic models with 2 and 4 change-over contacts, respectively, having similar electrical specifications.

With their **compact dimensions** and **optimum performance**, these relays are suitable for the widest imaginable range of applications, from controlling devices such as HV/MV breakers to the supervision of low power logic circuits. The contacts used are designed to give good levels of performance both with **high and strongly inductive DC loads**, and with particularly **low loads** such as interface signals; inclusion of the magnetic arc blow-out function (optional) helps to achieve a significant increase in breaking capacity. Knurled contacts ensure not only better self-cleaning characteristics, but also lower ohmic resistance thanks to multiple points of electrical connection, thereby extending the electrical life expectancy of the component.

The construction of the relays and their simplified mechanical design combine to ensure these products offer **high reliability in operation**, as proven by their use **for over 40 years** in electrical energy transmission and distribution systems, and fixed equipment used in the railway sector. Benefiting from careful selection of materials, coupled with the tech-

nical and professional skills of human resources involved in design and production, this family of relays has found favor with many customers.

Like all Chauvin Arnoux relays, the models in the C and D series are assembled as part of a controlled manufacturing process in which every step of production is verified by the next step in succession. In effect, **each relay is calibrated and tested individually**, by hand, in such a way as to guarantee **top reliability**.

Versatility in manufacture allows the production of relays with any voltage in the range 12 to 220VDC/440VAC, and with a variety of operating ranges adaptable to **various application requirements**. Typical sectors of use are among the **most demanding**, such as, for example, electricity generating stations, electrical transformer stations, fixed equipment for railways, or industries using continuous production processes (chemical and petrochemical, rolling mills, cement factories, etc.). To simplify the operations of installing the relay on the various dedicated sockets, the sockets themselves are equipped with special catches allowing the installer to dispense with retaining clips, although these remain available as accessories.

MONOSTABLE INSTANTANEOUS
 INSTANTANEOUS MONOSTABLE WITH FORCIBLY GUIDED CONTACTS
 BISTABLE
 FAST-ACTING MONOSTABLE (ON PICK-UP AND BISTABLE)
 TIME DELAY (ON PICK-UP OR DROP-OUT)
 TIME DELAY WITH FORCIBLY GUIDED CONTACTS
 MEASUREMENT
 SOCKET NUMBERING EXPLANATIONS
 FRONT CONNECTION
 BACK CONNECTION
 PCB MOUNT
 RETAINING CLIPS
 KEYING

Models	Number of contacts	Magnetic arc blow-out	PCB-mount
RCMEx2 - RCMFx2	2		
RCMMx2	2		•
RCMEx6 - RCMFx6	2	•	
RCMMx6	2	•	•
RDMEx2 - RDMFx2	4		
RDMMx2	4		•
RDMEx6 - RDMFx6	4	•	
RDMMx6	4	•	•

⚠ TO COMPOSE THE PRODUCT CODE, SEE THE "ORDERING SCHEME" TABLE

Coil specifications	RCM	RDM
Nominal voltages Un	DC: 12-24-48-110-125-132-144-220 ⁽¹⁾ - AC: 12-24-48-110-125-220-230-380-440 ⁽¹⁻²⁾	
Power consumption Un (DC/AC)	2W ⁽³⁾ / 3.2VA ⁽⁴⁾ - 4VA ⁽⁵⁾	2.5W / 5VA ⁽⁴⁾ - 7.5VA ⁽⁵⁾
Operating range	DC: 80...120 % Un - AC : 85...110 % Un	
Type of duty	Continuous	
Droup-out voltage ⁽⁶⁾	DC: > 5 % Un - AC: > 15 % Un	

- (1) Other values on request.
- (2) Maximum AC value = 380V 50Hz - 440V 60Hz.
- (3) 2.3W for 220Vdc.
- (4) In operation.
- (5) On pick-up.
- (6) Limit value for supply voltage, expressed as % of the nominal value, beneath which the relay is certain to be de-energized.

Contact specifications	RCM		RDM	
Number and type	2 CO, form C		4 CO, form C	
Current	10A			
Nominal ⁽¹⁾	13A for 1min - 20A for 1s			
Maximum peak ⁽²⁾	100A for 10ms			
Maximum pulse ⁽²⁾				
Example of electrical life expectancy ⁽³⁾	RCM.x2 - RDM.x2: 0.2A - 110Vdc - L/R 40ms - 500,000 operations – 1,800 operations/hour RCM.x6 - RDM.x6: 0.5A - 110Vdc - L/R 40ms - 150,000 operations – 1,800 operations/hour			
Minimum load	200mW (10V, 10mA) 50mW (5V, 5mA)			
Standard contacts				
Gold-plated contact				
Maximum drop-out voltage	250 Vdc / 300 Vac			
Contact material	AgCdO (moving contacts) - AgNi (fixed contacts)			
	RCM.12-16-42-46	RCM.32-36-62-66	RDM.12-16-42-46	RDM.32-36-62-66
Operating time at Un (ms) ⁽⁴⁾	DC - AC	DC	DC - AC	DC
Pick-up (NC contact opening)	≤ 10 - ≤ 10	≤ 10	≤ 14 - ≤ 10	≤ 14
Pick-up (NO contact closing)	≤ 19 - ≤ 18	≤ 19	≤ 23 - ≤ 17	≤ 23
Drop-out (NO contact opening)	≤ 4 - ≤ 8	≤ 11	≤ 5 - ≤ 8	≤ 32
Drop-out (NC contact closing)	≤ 16 - ≤ 19	≤ 28	≤ 14 - ≤ 19	≤ 45

- (1) On all contacts simultaneously, reduction of 30%.
- (2) Maximum peak and pulse currents are those currents that can be handled, for a specified time, by the contact. They do not refer to steady or interrupted currents.
- (3) For other examples, see electrical life expectancy curves.
- (4) Unless specified otherwise, operating times are understood as comprising stabilization of the contact (inclusive of bounces).

Insulation	
Insulation resistance (at 500Vdc)	
between electrically independent circuits and between these circuits and ground	> 1,000 MΩ
between open contact parts	> 1,000 MΩ
Withstand voltage at industrial frequency	
between electrically independent circuits and between these circuits and ground	2 kV (1 min) - 2.2 kV (1 s)
between open contact parts	2 kV (1 min) - 2.2 kV (1 s)
between adjacent contacts	2 kV (1 min) - 2.2 kV (1 s)
Impulse withstand voltage (1.2/50μs - 0.5J)	
between electrically independent circuits and between these circuits and ground	5 kV
between open contact parts	3 kV



Mechanical specifications

Mechanical life expectancy	20x10 ⁶ operations	
Maximum switching rate	Mechanical	3,600 operations/hour
Protection (with relay mounted)	IP40	
	RCM	RDM
Dimensions (mm)	40x20x50 ⁽¹⁾	40x40x50 ⁽¹⁾
Weight (g)	60	115

1. Excluding output terminals.



Environmental specifications

Operating temperature	-25 to +55 °C
Storage and shipping temperature	-25 to +70°C
Relative humidity	Standard: 75% RH - Tropicalized: 95% RH
Fire behavior	V0



Standards and reference values

EN 61810-1, EN 61810-2, EN 61810-7 EN 60695-2-10 EN 61000 EN 60529	Electromechanical elementary relays Fire behavior Electromagnetic compatibility Degree of protection provided by enclosures
---	--

Unless otherwise specified, products are designed and manufactured according to the requirements of the European and International standards indicated above. In accordance with EN 61810-1, all items of technical data are referred to ambient temperature 23 °C, atmospheric pressure 96kPa and 50% humidity. Tolerance for coil resistance, nominal electrical input and nominal power is ±7%.



Configurations - Options

TROPICALIZATION	Surface treatment of the coil with protective coating for use with RH 95%.
GOLD PLATING	Surface treatment of contacts, blades and output terminals with gold-cobalt alloy, thickness ≥2μ. This treatment ensures long-term capacity of the contact to conduct lower currents.
LED	LED indicator showing presence of power supply, wired in parallel with the coil, as alternative to mechanical optical indicator.
FLYBACK DIODE	Component connected in parallel with the coil (type 1N4007) designed to suppress overvoltages generated by the coil when de-energized.



Ordering scheme

Product code	Application ⁽¹⁾	Configuration A	Configuration B	Label	Type of power supply	Nominal voltage (V) ⁽²⁾	Finish ⁽³⁾	Keying position code ⁽⁴⁾
RCM (2 contacts)	E: Energy / Railway fixed M: For PCB mounting	1: Standard 3: Diode // 4: Gold plating 5: LED 6: Gold plating + Diode // 7: Diode // + LED	2: Standard 6: With magnetic blow-out	F	C: Vdc A: Vac 50Hz H: Vac 60 Hz	012 - 024 - 048 110 - 125 - 132 144 - 220 - 230 380 - 440	T: Tropicalized coil	xx
RDM (4 contacts)								

Example	RCM	E	4	2	F	A	048	T	
	RGME37F -A048T = ENERGY series relay with 2 CO gold-plated contacts, 48V 50Hz tropicalized coil								
	RDM	E	1	6	F	C	110		DH
RGMF17F-C110-DH = RAILWAY series relay, fixed equipment, with 4 CO gold-plated contacts, magnetic arc blow-out, 110Vdc coil and keying position DH									

(1) ENERGY: all applications except for railway.

RAILWAYS, FIXED EQUIPMENT: application on fixed power systems and electrical railway traction.

For list of RFI compliant and type-approved products, consult dedicated catalog "RAILWAY SERIES – RFI APPROVED".

M: PCB-mount models. Specifications as per "Energy" application but with output terminals suitable for soldering to PCB.

Also available is the STATIONS series, with ENEL approved material meeting LV15/LV16 specifications. For list of ENEL compliant and type-approved products, consult dedicated catalog "STATIONS SERIES – LV15-LV16-LV20"

(2) Other values on request. Voltages 380V and 440V available as Vac only.

(3) Optional value.

(4) Optional value. The positive mechanical keying is applied according to the manufacturer's model.

Wiring diagram

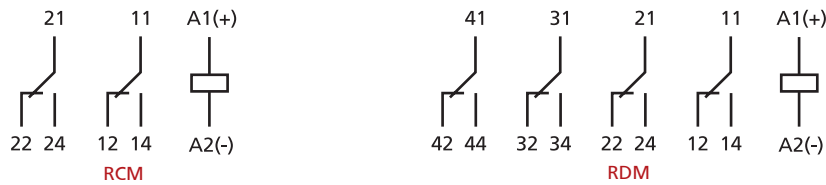

Dimensions

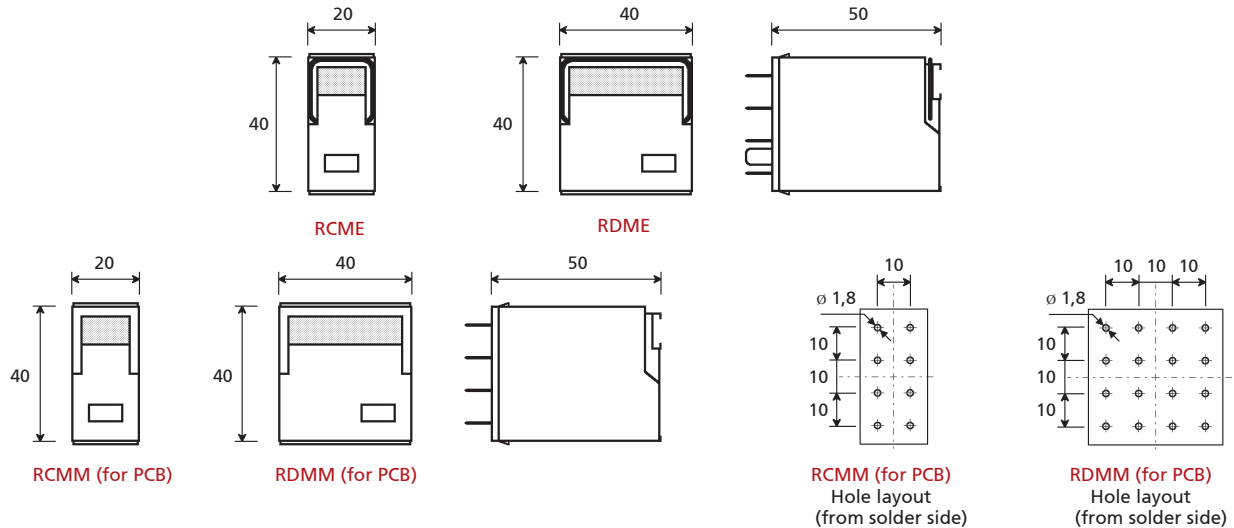

Electrical life expectancy

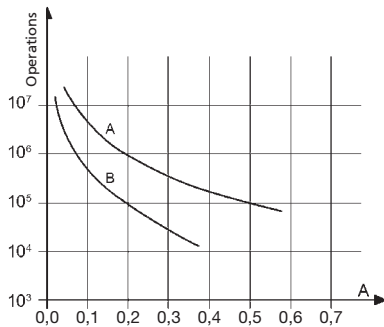

Contact loading: 110 Vdc, L/R 40 ms
 Curve A : RCM.x6, RDM.x6
 Curve B : RCM.x2, RDM.x2

RCM.12, RDM.12			
U	I (A)	L/R (ms)	Operations
110Vdc	0.2	40	500,000
220Vdc	0.2	10	80,000
U	I (A)	cosφ	Operations
110Vac	1	1	1,200,000
110Vac	1	0.5	1,000,000
110Vac	5	1	500,000
110Vac	5	0.5	300,000
220Vac	0.5	1	1,200,000
220Vac	1	0.5	500,000
220Vac	5	1	400,000
220Vac	5	0.5	300,000

Switching frequency: 1,200 operations/hour
 (*) = 600 operations/hour

RCM.16, RDM.16			
U	I (A)	L/R (ms)	Operations
110Vdc	0.2	40	1,000,000
110Vdc	0.5	40	150,000
110Vdc	0.6	10	300,000
110Vdc	1	10	100,000 (*)
220Vdc	0.2	10	100,000
U	I (A)	cosφ	Operations
110Vac	1	1	2,000,000
110Vac	1	0.5	1,500,000
110Vac	5	1	950,000
110Vac	5	0.5	500,000
220Vac	0.5	1	2,000,000
220Vac	1	0.5	800,000
220Vac	5	1	600,000
220Vac	5	0.5	500,000

Sockets and retaining clips		RCM	RDM	Retaining clip
Type of installation	Type of outputs			
Wall or DIN H35 rail mounting	Screw	PAVC081	PAVD161 PAVD164	VM1821
	Double faston (4.8 x 0.8 mm)	PRDC081	-	-
Flush mounting	Screw	PRVC081	PRVD161	-
	Solder	PRCC081	PRCD161	-
PCB-mount	Solder	PRCC081	PRCD161	-

Mounting tips

The preferred mounting position is on the wall, with the relay positioned horizontally in the reading direction on the nameplate. For correct use of the relays, they should be spaced apart by at least 5 mm in the horizontal direction and 20 mm in the vertical direction. This is to allow correct upward dissipation of the heat generated by the coil. Set these distances according to the socket used. Distances can be reduced depending on the environmental application conditions and on the relay duty cycle. No special maintenance is required. Condensation can form inside the relay when powered up and the outside ambient temperature is cold; this is quite normal and does not affect the operation of the relay. The plastic materials of the relay do not possess hygroscopic properties.



RELAYS

MONOSTABLE INSTANTANEOUS RELAY 4 CONTACTS

RGM SERIES

USER SECTORS



Power generation



Nuclear



Power transmission



Rolling stock



Fixed railway installations



Shipbuilding



Petroleum industry



Heavy industry

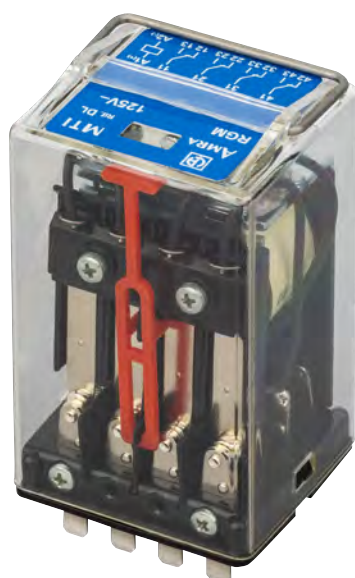

RGM

PRODUCT ADVANTAGES

- Plug-in monostable instantaneous relay
- Solid and rugged construction for heavy or intensive duty
- Very long electrical life expectancy and exceptional endurance
- Magnetic arc blow-out for higher breaking capacity
- Self-cleaning knurled contacts
- Lever for manual operation (optional)
- Fitted with mechanical optical contact status indicator as standard
- Operation using DC or AC power supply (directly, without rectifiers or diodes)
- Wide variety of configurations and customizations
- Also available in current-monitoring version
- Retaining clip for secure locking of relay on socket
- Transparent cover, pull-out handle
- Label holder in cover for customer's use
- Positive mechanical keying for relay and socket

DESCRIPTION

The relays in the **RGM series** are highly reliable products **providing top performance**, suitable for applications in particularly **harsh and unsettled environments**, such as high voltage electricity distribution stations and medium voltage substations. The mechanical design of the relay is such as to allow the development of **numerous custom solutions**, in the event that the standard models do not fully respond to the required performance parameters. Thanks to its exceptional breaking capacity, the relay is suitable for controlling heavy duty loads with intensive switching frequency, where safety and continuity of operation are all-important. A product of proven reliability, as demonstrated by its **use for over 40 years** in electrical energy transmission and distribution systems, and fixed equipment used in the railway sector. Benefiting also from **careful selection of materials**, coupled with the technical and professional skills of human resources involved in design and production, this family of relays has found favour with many important and high profile customers..

Versatility in manufacture allows the production of relays with any voltage in the range 12 to 250VDC/440VAC, and with

a variety of operating ranges adaptable to different application requirements.

The contacts used are of a type designed to give notable levels of performance both with **high and strongly inductive DC loads**, and with particularly **low loads**; inclusion of the magnetic arc blow-out function (optional) helps to achieve a considerable increase in breaking capacity. Knurled contacts ensure not only better self-cleaning characteristics, but also lower ohmic resistance thanks to multiple points of electrical connection, thereby extending the electrical life expectancy of the component.

All models offer the facility of manual operation, so that tests can be performed even in the absence of electrical power. Like all our relays, models in the G series are assembled as part of a controlled manufacturing process in which **every step of production is verified** by the next step in succession. In effect, **each relay is calibrated and tested individually**, by hand, in such a way as to guarantee top reliability.

MONOSTABLE INSTANTANEOUS
 INSTANTANEOUS MONOSTABLE WITH FORCIBLY GUIDED CONTACTS
 BISTABLE
 FAST-ACTING MONOSTABLE (AND BISTABLE)
 TIME DELAY (ON PICK-UP OR DROP-OUT)
 TIME DELAY WITH FORCIBLY GUIDED CONTACTS
 MEASUREMENT
 SOCKET NUMBERING EXPLANATIONS
 FRONT CONNECTION
 BACK CONNECTION
 PCB MOUNT
 RETAINING CLIPS
 KEYING

Models	Number of contacts	Magnetic arc blow-out
RGM.x3	4	
RGM.x4	4 + 1NO	
RGM.x5	4 + 1NC	
RGM.x7	4	•
RGM.x8	4, long travel	•

FOR CONFIGURATION OF THE PRODUCT CODE, SEE "ORDERING SCHEME" TABLE

Coil specifications	RGMExy - RGMFxy	RGMEx8
Nominal voltages Un	DC: 12-24-48-110-125-132-144-220 ⁽¹⁾ - AC: 12-24-48-110-125-220-230-380-440 ⁽¹⁻²⁾	
Consumption at Un (DC/AC)	3W / 6.5VA ⁽³⁾ - 11.5VA ⁽⁴⁾	3.5W / 8VA ⁽³⁾ - 13VA ⁽⁴⁾
Operating range	DC: 80...120 % Un - AC : 85...110 % Un	
Type of duty	Continuous	
Drop-out voltage ⁽⁵⁾	DC: > 5% Un - AC : > 15% Un	

- (1) Other values on request.
 (2) 380V 50Hz, 440V 60Hz.
 (3) In operation.
 (4) On pick-up.
 (5) Limit value for supply voltage, expressed as % of the nominal value, beneath which the relay is certain to be de-energized.

Contact specifications

Number and type	4 CO, form C								
Current	Nominal ⁽¹⁾	12 A ⁽²⁾							
	Maximum peak ⁽²⁾	20A for 1min - 40A for 1s							
	Maximum pulse ⁽²⁾	150A for 10ms							
Example of electrical life expectancy ⁽⁴⁾	RGM.x3-x4-x5 : 0.5A - 110Vdc - L/R 40 ms - 10 ⁵ operations - 1,800 operations/hour RGM.x4-x5 (NC or NO auxiliary contact) : 0.2 A - 110 Vdc - L/R 40 ms - 10 ⁵ operations - 1,800 operations/hour RGM.x7 : 1A - 110 Vdc - L/R 40 ms - 10 ⁵ operations- 1,800 operations/hour RGM.x8 : 1 A - 125 Vdc - L/R 40 ms - 10 ⁶ operations - 600 operations/hour								
Minimum load	Standard contacts	200mW (10V, 10mA)							
	Gold-plated contacts	50mW (5V, 5mA)							
Maximum breaking voltage	350 VDC / 440 VAC								
Contact material	AgCdO								
Operating time at Un (ms) ⁽⁵⁾		RGM.13-17-43-47	RGM. 33-37-63-67	RGM.18	RGM.38	RGM.14-44	RGM. 34-64	RGM. 15-45	RGM. 35-65
	DC - AC	DC	DC	DC - AC	DC	DC - AC	DC	DC - AC	DC
	Pick-up (NC contact opening)	≤ 20 - ≤ 11	≤ 20	≤ 20 - ≤11	≤ 20	≤ 16 - ≤ 11	≤ 16	≤ 16 - ≤11	≤16
	Pick-up (NO contact closing)	≤ 35 - ≤ 30	≤ 35	≤ 40 - ≤35	≤ 40	≤ 35 - ≤ 30	≤ 35	≤ 35 - ≤30	≤35
	Drop-out (NO contact opening)	≤ 10 - ≤ 20	≤ 47	≤ 10 - ≤20	≤ 47	≤ 10 - ≤ 25	≤ 47	≤ 10 - ≤25	≤ 47
	Drop-out (NC contact closing)	≤ 53 - ≤ 65	≤ 85	≤ 60 - ≤70	≤ 95	≤ 70 - ≤ 75	≤ 100	≤ 70 - ≤75	≤ 100
	Pick-up (NC auxiliary contact opening)	-	-	-	-	-	-	≤ 16 - ≤12	≤ 20
	Pick-up (NO auxiliary contact closing)	-	-	-	-	≤ 33 - ≤ 25	≤ 33	-	-
Drop-out (NO auxiliary contact opening)	-	-	-	-	≤ 30 - ≤ 45	≤ 46	-	-	
Drop-out (NC auxiliary contact opening)	-	-	-	-	-	-	≤ 70 - ≤75	≤ 95	

- (1) On all contacts simultaneously, reduction of 30%.
 (2) Models RGM.x4 / RGM.x5 only: 5° NO or NC contact: nominal current 5 A.
 (3) Maximum peak and pulse currents are those currents that can be handled, for a specified time, by the contact. They do not refer to steady or interrupted currents.
 (4) For other examples, see electrical life expectancy curves.
 (5) Unless specified otherwise, the operating time signifies until stabilization of the contact (including bounces).

Insulation

Insulation resistance (at 500Vdc)	
between electrically independent circuits and between these circuits and ground	> 10,000 MΩ
between open contact parts	> 10,000 MΩ
Withstand voltage at industrial frequency	
between electrically independent circuits and between these circuits and ground	2 kV (1 min) - 2.2 kV (1 s)
between open contact parts	2 kV (1 min) - 2.2 kV (1 s) ⁽¹⁾
between adjacent contacts	2 kV (1 min) - 2.2 kV (1 s)
Impulse withstand voltage (1.2/50µs - 0.5J)	
between electrically independent circuits	5 kV ⁽²⁾
and between these circuits and ground	5 kV ⁽²⁾

For auxiliary contacts (NO - NC) of models RGM.x4 and RGM.x5:

- (1) 1kV.
 (2) 2kV.



Mechanical specifications

	Mechanical life expectancy	20 x 10 ⁶ operations
Maximum switching rate	Mechanical	3,600 operations/hour
	Protection	IP40
	Dimensions (mm)	45x50x86 ⁽¹⁾
	Weight (g)	270

(1) Excluding output terminals



Environmental specifications

Operating temperature	-25 to +55 °C
Storage and shipping temperature	-25 to +70°C
Relative humidity	Standard: 75% RH - Tropicalized: 95% RH
Fire behavior	V0



Standards and reference values

EN 61810-1, EN 61810-2, EN 61810-7 EN 60695-2-10 EN 61000 EN 60529	Electromechanical elementary relays Fire behavior Electromagnetic compatibility Degree of protection provided by enclosures
---	--

Unless otherwise specified, products are designed and manufactured according to the requirements of the European and International standards indicated above.

In accordance with EN 61810-1, all items of technical data are referred to ambient temperature 23 °C, atmospheric pressure 96kPa and 50% humidity.

Tolerance for coil resistance, nominal electrical input and nominal power is ±7%.



Configurations - Options

TROPICALIZATION	Surface treatment of coil with protective coating for use in conditions of RH 95%.
GOLD PLATING	Surface treatment of contacts, blades and output terminals with gold-cobalt alloy, thickness ≥2μ. This treatment ensures long-term capacity of the contact to conduct lower currents.
LED	LED indicator showing presence of power supply, wired in parallel with the coil, as alternative to mechanical optical indicator.
FLYBACK DIODE	Component connected in parallel with the coil (type 1N4007) designed to suppress overvoltages generated by the coil when de-energized.
LEVER FOR MANUAL OPERATION	Allows manual operation of the relay, with the cover closed, using a screwdriver. If the lever is fitted, there will be no luminous optical indicator.



Ordering scheme

Product code	Application ⁽¹⁾	Configuration A	Configuration B	Label	Type of power supply	Nominal voltage (V) ⁽²⁾	Finish ⁽³⁾	Keying position code ⁽⁴⁾
RGM	E: Energy F: Railway Fixed Equipment	1: Standard 3: Diode // 4: Gold plating 5: Led 6: Gold plating + Diode // 7: Diode // + Led	3: 4 CO contracts 4: 4 CO contracts + 1 NO auxiliary contact 5: 4 CO contracts + 1 NC auxiliary contact 7: 4 CO contracts with magnetic arc blow-out 8: 4 CO contracts, long travel with magnetic arc blow-out	F	C: Vdc A: Vac 50 Hz H: Vac 60 Hz	012 - 024 - 048 110 - 125 - 132 144 - 220 - 230 380 - 440	T: Tropicalized coil M: Manual operation ⁽⁵⁾	xxx

Example	RGM	E	3	7	F	C	048	TM	
	RGM E37F-C048/TM = ENERGY series relay with flyback diode, magnetic arc blow-out, 48Vdc tropicalized coil and manual operating lever.								
	RGM	E	1	3	F	A	110		OOG
RGM E17F-A110-OOG = RAILWAY series relay, fixed equipment, with 110V 50Hz coil and keying position OOG.									

(1) ENERGY: all applications except for railway.

RAILWAYS, FIXED EQUIPMENT: application on fixed power systems and electrical railway traction. For list of RFI compliant and type-approved products, consult dedicated catalog "RAILWAY SERIES - RFI APPROVED".

Also available is the STATIONS series, with ENEL approved material meeting LV15/LV16 specifications. For list of ENEL compliant and type-approved products, consult dedicated catalog "STATIONS SERIES - LV15-LV16-LV20".

(2) Other values on request. Voltages 380V and 440V available as Vac only.

(3) Optional value. Multiple selection possible (e.g. TM).

(4) Optional value. Positive mechanical keying is applied according to the manufacturer's model.

(5) With manual operation, no optical indicator.

Wiring diagram

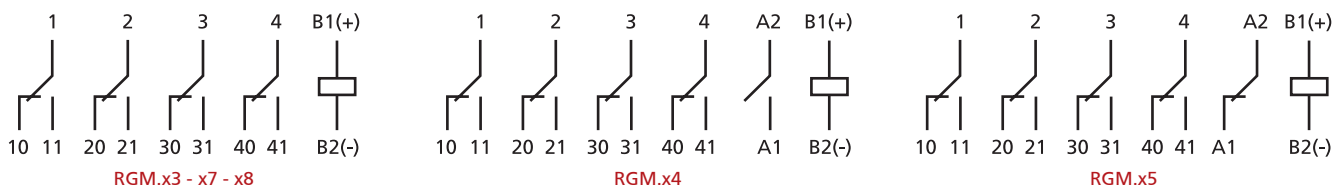

Dimensions

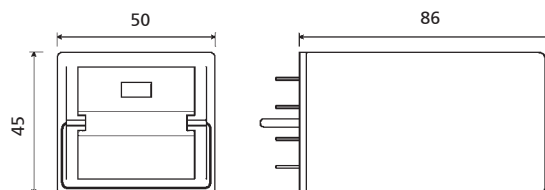

Electrical life expectancy

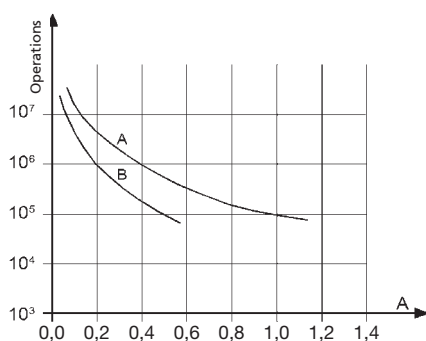

Contact loading: 110 Vdc, L/R 40 ms
 Curve A : RGM.x7
 Curve B : RGM.x3-4-5(NO/NC contact excluded)

RGM.x3 - RGM.x4 - RGM.x5			
U	I (A)	L/R (ms)	Operations
110 Vdc	0.5	40	100,000
110 Vdc	0.6	10	300,000
120 Vdc	0.7	40	50,000
125 Vdc	1.2	0	1,000,000
220 Vdc	0.1	40	100,000
220 Vdc	0.25	10	100,000
U	I (A)	cosφ	Operations
110 Vac	1	1	2,000,000
110 Vac	1	0.5	1,500,000
110 Vac	5	1	1,000,000
110 Vac	5	0.5	500,000
220 Vac	0.5	1	2,000,000
220 Vac	1	0.5	600,000
220 Vac	5	1	650,000
220 Vac	5	0.5	600,000

Switching frequency: 1,200 operations/hour

RGM.x7			
U	I (A)	L/R (ms)	Operations
24 Vdc	1	0	7,000,000
24 Vdc	1	40	3,000,000
24 Vdc	2	40	2,000,000
24 Vdc	5	0	3,000,000
24 Vdc	5	40	200,000
24 Vdc	9	0	800,000
48 Vdc	5	20	200,000
110 Vdc	0.4	40	1,000,000
110 Vdc	1	40	100,000
110 Vdc	10	0	100,000
U	I (A)	cosφ	Operations
220 Vac	5	0.5	100,000
220 Vac	10	1	100,000
230 Vac	1	0.7	2,500,000
230 Vac	3	0.7	1,200,000

RGM.x8			
U	I (A)	L/R (ms)	Operations
125 Vdc	1	40	1,000,000
125 Vdc	5	40	5,000

Sockets and retaining clips

Type of installation	Type of outputs	Model	Retaining clip
Wall or DIN rail mounting	Screw	PAVG161	VM1221
Flush mounting	Double faston (4.8 x 0.8 mm)	PRDG161	
	Screw	PRVG161	

Mounting tips

The preferred mounting position is on the wall, with the relay positioned horizontally in the reading direction on the nameplate. For correct use of the relays, they should be spaced apart by at least 5 mm in the horizontal direction and 20 mm in the vertical direction. This is to allow correct upward dissipation of the heat generated by the coil. Set these distances according to the socket used. Distances can be reduced depending on the environmental application conditions and on the relay duty cycle. For safe and secure operation, it is advisable to use retaining clips.

No special maintenance is required.

Condensation can form inside the relay when powered up and the outside ambient temperature is cold; this is quite normal and does not affect the operation of the relay. The plastic materials of the relay do not possess hygroscopic properties.



RELAYS

INSTANTANEOUS MONOSTABLE RELAY WITH 8 CHANGE-OVER CONTACTS

RMMX SERIES

USER SECTORS



Power generation



Nuclear



Power transmission



Rolling stock



Fixed railway installations



Shipbuilding



Petroleum industry



Heavy industry



RMM

PRODUCT ADVANTAGES

- Plug-in monostable instantaneous relay
- Compact dimensions than RMM Series
- Solid and rugged construction for heavy or intensive duty
- Long electrical life expectancy and exceptional endurance
- Operation using d.c. or a.c. power supply (directly, without rectifiers or diodes)
- Magnetic arc blow-out (optional) for higher breaking capacity
- Self-cleaning knurled contacts
- Mechanical optical device (standard) or Led (optional for d.c. versions) indicating energized status of coil
- Transparent cover, with access for manual operation (standard) and pull-out handle
- Retaining clip for secure locking of relay on socket
- Positive mechanical keying for relay and socket

DESCRIPTION

RMMX relays line are derived from models in the RGMX line, offering the same specifications and performance and available with a generous number of contacts (8): in short, highly reliable products providing top performance and suitable for applications in particularly harsh and unsettled environments, such as high voltage electricity distribution stations and medium voltage substations. The mechanical design of the relay is such as to allow the development of **numerous custom solutions**, in the event that the standard models do not fully respond to the required performance parameters.

Thanks to its high breaking capacity, the relay is suitable for controlling **heavy duty loads** with intensive switching frequency, where safety and continuity of operation are all-important.

Versatility in manufacture allows the production of relays with any voltage between 12 and 250Vd.c./380Va.c.

Manual operation is specified for all models, allowing tests to be conducted in the absence of any power supply.

The contacts used are of a type designed to give top performance both with high and strongly inductive d.c. loads, and with particularly low loads; inclusion of the magnetic arc blow-out function (optional) helps to achieve a considerable **increase in breaking capacity**.

Knurled contacts ensure not only better self-cleaning characteristics, but also lower ohmic resistance thanks to multiple points of electrical connection, thereby extending the electrical life expectancy of the component.

Benefiting from careful selection of materials, plus the technical and professional skills of human resources involved in design and production, this is a product suitable for the most demanding of environments.

Like all our relays, these models are assembled as part of a controlled manufacturing process in which every step of production is verified by the next step in succession.

Each relay is calibrated and tested individually, by hand, so as to guarantee top reliability.

Model	Number of contacts	Magnetic arc blow-out
RMM.x2X	8	
RMM.x6X	8	•

FOR CONFIGURATION OF PRODUCT CODE, SEE "ORDERING SCHEME" TABLE

Coil specifications	RMM.x2X-x6X
Nominal voltages Un	DC: 12-24-48-110-125-132-220 ⁽¹⁾ - AC: 12-24-48-110-125-230-380-440 ⁽¹⁻²⁾
Consumption at Un (DC/AC)	3W / 6.5 VA ⁽³⁾ - 11.5 VA ⁽⁴⁾
Operating range	DC: 80÷115% Un - AC: 85÷110% Un
Type of duty	Continuous
Drop-out voltage ⁽⁵⁾	DC: > 5% Un - AC: > 15% Un

- (1) Other values on request.
- (2) Maximum value, AC = 380V 50Hz - 440V 60Hz.
- (3) In operation.
- (4) On pick-up.
- (5) Limit value for supply voltage, expressed as % of the nominal value, beneath which the relay is certain to be de-energized.

Contact specifications	RMM.12X-16X-42X-46X	RMM.32X-36X-52X-56X-62X-66X-72X-76X	
Number and type	8 CO, form C		
Current	Nominal ⁽¹⁾	10A	
	Maximum peak ⁽²⁾	20A for 1min - 40A for 1s	
	Maximum pulse ⁽²⁾	150A for 10ms	
Example of electrical life expectancy ⁽³⁾	RMME _x 2X: 0.5A - 110Vdc - L/R 40ms - 10 ⁵ operations - 1,800 operations/hour RMME _x 6X: 1A - 110 Vdc - L/R 40ms - 10 ⁵ operations - 1,800 operations/hour		
Minimum load	Standard contacts	200 mW (10 V, 10 mA)	
	Gold-plated contacts	50 mW (5 V, 5 mA)	
Maximum breaking voltage	350 VDC / 440 VAC		
Contact material	AgCdO		
Operating time at Un (ms) ⁽⁴⁾	DC - AC	DC	
	Pick-up (NC contact opening)	≤ 20 - ≤ 13	≤ 20
	Pick-up (NO contact closing)	≤ 45 - ≤ 50	≤ 45
	Drop-out (NO contact opening)	≤ 8 - ≤ 25	≤ 42
	Drop-out (NC contact closing)	≤ 45 - ≤ 60	≤ 85

- (1) On all contacts simultaneously, reduction of 30%.
- (2) Maximum peak and pulse currents are those currents that can be handled, for a specified time, by the contact. They do not refer to steady or interrupted currents.
- (3) For other examples, see electrical life expectancy curves.
- (4) Unless specified otherwise, the operating time signifies until stabilization of the contact (including bounces).

Insulation	
Insulation resistance (at 500VCD) between electrically independent circuits and between these circuits and ground between open contact parts	> 10,000 MΩ > 10,000 MΩ
Withstand voltage at industrial frequency between electrically independent circuits and between these circuits and ground between open contact parts between adjacent contacts	2 kV (1 min) - 2.2 kV (1 s) 2 kV (1 min) - 2.2 kV (1 s) 2 kV (1 min) - 2.2 kV (1 s)
Impulse withstand voltage (1.2/50µs - 0.5J) between electrically independent circuits and between these circuits and ground between open contact parts	5 kV 5 kV

Mechanical specifications	
Mechanical life expectancy	20x10 ⁶ operations
Maximum mechanical switching rate	3,600 operations/h
Degree of protection	IP50 fitted to socket
Dimensions (mm)	45x90x100 ⁽¹⁾
Weight (g)	380

(1) Excluding output terminal

Environmental specifications	
Operating temperature	-25 ÷ +55°C
Storage and shipping temperature	-25 ÷ +70°C
Relative humidity	Standard: 75% RH - Tropicalized: 95% RH
Fire behavior	V0

Standards and reference values	
EN 61810-1, EN 61810-2, EN 61810-7 EN 60695-2-10 EN 60529	All-or-nothing relays Fire behavior Degree of protection provided by enclosures

Unless otherwise specified, products are designed and manufactured to the requirements of the European and International standards indicated above. In accordance with EN 61810-1, all items of technical data are referred to ambient temperature 23 °C, atmospheric pressure 96kPa and 50% humidity. Tolerance for coil resistance, nominal electrical input and nominal power is ±7%.

Configurations - Options	
TROPICALIZATION	Surface treatment of coil with protective coating for use in conditions of RH 95%. This treatment serves to give the coil added protection against corrosion that could occur as a result of moisture reacting with certain chemical agents such as those found in acid or saline atmospheres.
GOLD PLATING	Surface treatment of contacts, blades and output terminals with gold, thickness ≥ 2μ. This treatment ensures long-term capacity of the contact to conduct low levels of current, even in adverse ambient conditions.
LED	Luminous indicator showing presence of power supply, wired in parallel with the coil, as alternative to mechanical optical indicator.
FLYBACK DIODE	Component connected in parallel with the coil designed to suppress overvoltages generated by the coil when de-energized.

Ordering scheme

Product code	Application ⁽¹⁾	Configuration A	Configuration B	Label	Type of power supply	Nominal voltage (V) ⁽²⁾	Finish ⁽³⁾	Keying position code ⁽⁴⁾
RMM	E: Energy F: Railway Fixed Equipment	1: Standard 3: Diode // 4: Gold plating 5: Led 6: Gold plating + Diode // 7: Diode // + Led	2X: 8 CO contacts 6X: 8 CO contacts with magnetic arc blow-out	F	C : Vdc A: Vac 50 Hz H: Vac 60 Hz	012 - 024 - 048 110 - 125 - 132 220 - 230 - 380 440	T: Tropicalized coil	XX

Example	RMM	E	4	6X	F	A	024	
	RMM E46XF-A024 = ENERGY series relay with 8 gold-plated contacts, magnetic arc blow-out and 24Vac coil.							
	RMM	F	1	2X	F	C	110	T
RMM F12XF-C110/T = Standard RAILWAY series relay with 8 contacts and 110Vdc tropicalized coil.								

(1) ENERGY : all applications except for railway.

RAILWAYS, FIXED EQUIPMENT: application on fixed power systems and electrical railway traction. For list of RFI compliant and type-approved products, consult dedicated catalog "RAILWAY SERIES – RFI APPROVED".

Also available is the STATIONS series, with ENEL approved material meeting LV15/LV16 specifications. For list of ENEL compliant and type-approved products, consult dedicated catalog "STATIONS SERIES – LV15-LV16-LV20".

(2) Other values on request. Voltages 380V and 440V available as Vac only.

(3) (4) Optional value. Positive mechanical keying is applied according to the manufacturer's product model.

Wiring diagram

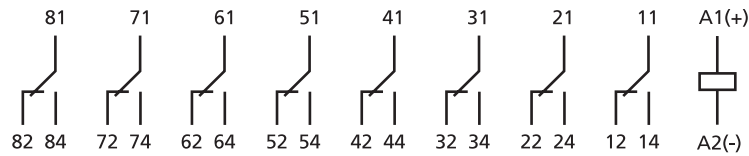

Dimensions

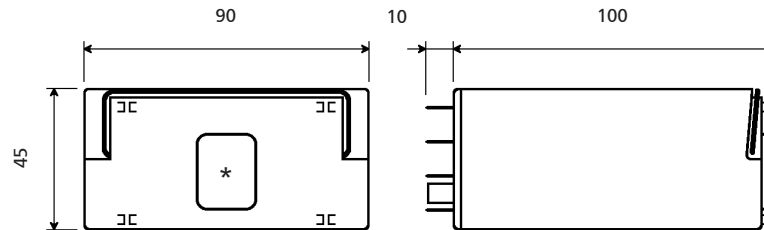

(*) access to the manual operating lever

Electrical life expectancy

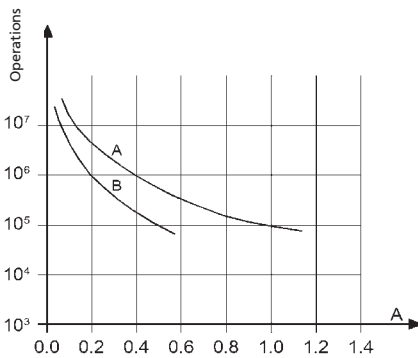

Contact loading: 110Vdc, L/R 40 ms
 Curve A: RMM.x6X
 Curve B: RMM.x2X

RMM.x2X			
U	I (A)	L/R (ms)	Operations
110 Vdc	0.5	40	1,000,000
110 Vdc	0.6	10	300,000
120 Vdc	0.7	40	50,000
125 Vdc	1.2	0	1,000,000
220 Vdc	0.1	40	100,000
220 Vdc	0.25	10	100,000
U	I (A)	cosφ	Operations
110 Vac	1	1	2,000,000
110 Vac	1	0.5	1,500,000
110 Vac	5	1	1,000,000
110 Vac	5	0.5	500,000
220 Vac	0.5	1	2,000,000
220 Vac	1	0.5	600,000
220 Vac	5	1	650,000
220 Vac	5	0.5	600,000

RMM.x6X			
U	I (A)	L/R (ms)	Operations
24 Vdc	1	0	7,000,000
24 Vdc	1	40	3,000,000
24 Vdc	2	40	2,000,000
24 Vdc	5	0	3,000,000
24 Vdc	5	40	200,000
24 Vdc	9	0	800,000
48 Vdc	5	20	200,000
110 Vdc	0.4	40	1,000,000
110 Vdc	1	40	100,000
110 Vdc	10	0	100,000
U	I (A)	cosφ	Operations
220 Vac	5	0.5	100,000
220 Vac	10	1	100,000
230 Vac	1	0.7	2,500,000
230 Vac	3	0.7	1,200,000

Switching frequency: 1,200 operations/hour

Sockets and retaining clips

Type of installation	Type of outputs	Modèle	Retaining clip
Wall or DIN rail mounting	Screw	96IP20-I DIN	RMC48
	Retaining clip	PAIR320	
Flush mounting	Double faston (4.8 × 0.8 mm)	ADF4	
	Retaining clip	PRIR320	

Mounting tips

The preferred mounting position is on the wall, with the relay positioned horizontally in the reading direction on the nameplate. To ensure correct use of the relays, they should be spaced apart by at least 20 mm in the vertical; this will allow the heat generated by the coils to rise and dissipate as necessary. Check the distances according to the socket used. Distances can be reduced depending on the environmental application conditions and on the relay duty cycle. Retaining clips are used to ensure that the relay is secured correctly to the socket. No special maintenance is required. Condensation can form inside the relay when powered up and the outside ambient temperature is cold; this is quite normal and does not affect the operation of the relay. The plastic materials of the relay do not possess hygroscopic properties.



RELAYS

INSTANTANEOUS MONOSTABLE RELAY 8-12-20 CONTACTS

RMM SERIES

USER SECTORS



Power generation



Nuclear



Power transmission



Rolling stock



Fixed railway installations



Shipbuilding



Petroleum industry



Heavy industry



RMME16

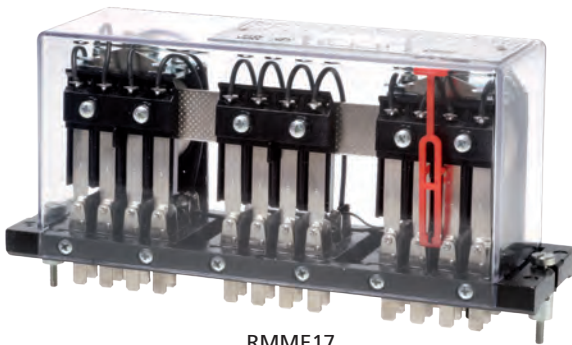

RMME17

PRODUCT ADVANTAGES

- Plug-in monostable instantaneous relay
- Compact dimensions than RMM Series
- Solid and rugged construction for heavy or intensive duty
- Long electrical life expectancy and exceptional endurance
- Operation using d.c. or a.c. power supply (directly, without rectifiers or diodes)
- Magnetic arc blow-out (optional) for higher breaking capacity
- Self-cleaning knurled contacts
- Operation using d.c. or a.c. power supply
- Transparent cover, with access for manual operation (standard) and pull-out handle
- Retaining clip for secure locking of relay on socket
- Positive mechanical keying for relay and socket

DESCRIPTION

Relays of the **RMM series** are monostable multipole types with 8, 12 and 20 change-over contacts. RMM relays share the same basic mechanical design as those of the RGM series, and offer the same specifications and performance.

These are highly reliable products providing top performance, suitable for applications in particularly harsh and unsettled environments, such as high voltage electricity distribution stations and medium voltage substations. The mechanical design of the relay is such as to allow the development of numerous custom solutions, in the event that the standard models do not fully respond to the required performance parameters. Thanks to its exceptional breaking capacity, the relay is suitable for controlling heavy duty loads with intensive switching frequency, where safety and continuity of operation are all-important. A product of proven reliability, as demonstrated by its use for over **40 years** in electrical energy transport and distribution systems, and fixed equipment used in the railway sector.

Benefiting also from careful selection of materials, coupled with the technical and professional skills of human resources involved in design and production, this family of relays has found favor with many important and high profile customers.

Versatility in manufacture allows the production of relays with any voltage in the range 12 to 250VDC/440VAC, and with a variety of operating ranges adaptable to different application requirements. The contacts used are of a type designed to give good levels of performance both with high and strongly inductive d.c. loads, and with particularly low loads. Inclusion of the magnetic arc blow-out function (optional) helps to achieve a considerable increase in breaking capacity, whilst the knurled contacts ensure not only better self-cleaning characteristics, but also lower ohmic resistance thanks to multiple points of electrical connection, thereby extending the electrical life expectancy of the component. All models offer the facility of manual operation, so that tests can be performed even in the absence of electrical power. To ensure that the relay remains firmly anchored to the sockets, these are equipped with fixing screws, so that there is no need for the use of retaining clips.

Like all AMRA relays, models of the RMM series are assembled as part of a controlled manufacturing process in which every step of production is verified by the next step in succession. In effect, each relay is calibrated and tested individually, by hand, in such a way as to guarantee the maximum level of reliability possible.

Models	Number of contacts	Magnetic arc blow-out
RMM.x2	8	
RMM.x6	8	•
RMM.x3	12	
RMM.x7	12	•
RMM.x4	20	
RMM.x8	20	•

FOR CONFIGURATION OF PRODUCT CODE, SEE "ORDERING SCHEME" TABLE

Coil specifications	RMM.x2-x6	RMM.x3-x4-x7-x8
Nominal voltages Un	DC: 12-24-48-110-125-132-144-220 ⁽¹⁾ - AC: 12-24-48-110-125-220-230-380-440 ⁽¹⁻²⁾	
Consumption at Un (DC/AC)	3 W / 6.5 VA ⁽³⁾ - 11.5 VA ⁽⁴⁾	6 W / 15 VA ⁽³⁾ - 25 VA ⁽⁴⁾
Operating range	DC: 80...120% Un - AC: 85...110% Un	
Type of duty Continuous	Continuous	
Drop-out voltage ⁽⁵⁾	DC: > 5% Un - AC: > 15% Un	

- (1) Other values on request.
- (2) Maximum value, a.c. = 380V 50Hz - 440V 60Hz.
- (3) In operation.
- (4) On pick-up.
- (5) Limit value for supply voltage, expressed as % of the nominal value, beneath which the relay is certain to be de-energized.

Contact specifications							
Number and type	8 - 12 - 20 CO, form C						
Current	Nominal ⁽¹⁾	10A					
	Maximum peak ⁽²⁾	20A for 1min - 40A for 1s					
	Maximum pulse ⁽²⁾	150A for 10ms					
Example of electrical life expectancy ⁽³⁾	RMM.x2-x3-x4: 0.5A - 110Vdc - L/R 40ms - 10 ⁵ operations - 1,800 operations/hour RMM.x6-x7-x8: 1A - 110 Vdc - L/R 40ms - 10 ⁵ operations - 1,800 operations/hour						
Minimum load	Standard contacts	200 mW (10 V, 10 mA)					
	Gold-plated contacts	50 mW (5 V, 5 mA)					
Maximum drop-out voltage	350 VDC / 440 VAC						
Contact material	AgCdO						
Operating time at Un (ms) ⁽⁴⁾	RMM. 12-16-42-46	RMM. 13-17-43-47	RMM. 14-18-44-48	RMM. 32-36-62-66	RMM. 33-37-63-67	RMM. 34-38-64-68	
	DC - AC	DC - AC	DC - AC	DC	DC	DC	
	Pick-up (NC contact opening)	≤ 15 - ≤ 10	≤ 13 - ≤ 10	≤ 14 - ≤ 10	≤ 15	≤ 13	≤ 14
	Pick-up (NO contact closing)	≤ 40 - ≤ 32	≤ 37 - ≤ 35	≤ 45 - ≤ 35	≤ 40	≤ 37	≤ 40
	Drop-out (NO contact opening)	≤ 12 - ≤ 30	≤ 12 - ≤ 30	≤ 8 - ≤ 35	≤ 104	≤ 31	≤ 35
Drop-out (NC contact closing)	≤ 64 - ≤ 110	≤ 70 - ≤ 80	≤ 42 - ≤ 73	≤ 150	≤ 80	≤ 75	

- (1) On all contacts simultaneously, reduction of 30%.
- (2) Maximum peak and pulse currents are those currents that can be handled, for a specified time, by the contact. They do not refer to steady or interrupted currents.
- (3) For other examples, see electrical life expectancy curves.
- (4) Unless specified otherwise, operating times are understood as comprising stabilization of the contact (inclusive of bounces).

Insulation		
Insulation resistance (at 500Vdc)	between electrically independent circuits and between these circuits and ground	> 10,000 MΩ
	between open contact parts	> 10,000 MΩ
Withstand voltage at industrial frequency	between electrically independent circuits and between these circuits and ground	2 kV (1 min) - 2.2 kV (1 s)
	between open contact parts	2 kV (1 min) - 2.2 kV (1 s)
	between adjacent contacts	2 kV (1 min) - 2.2 kV (1 s)
Impulse withstand voltage (1.2/50μs - 0.5J)	between electrically independent circuits and between these circuits and ground	5 kV
	between open contact parts	5 kV

Mechanical specifications		RMM.x2-x6	RMM.x3-x7	RMM.x4-x8
Mechanical life expectancy		20x10 ⁶ operations		
Maximum switching rate	Mechanical	3,600 operations/hour		
	Degree of protection	IP40		
	Dimensions (mm)	132x58x84 ⁽¹⁾	188x58x84 ⁽¹⁾	300x58x84 ⁽¹⁾
	Weight (g)	430	720	1100

(1) Excluding output terminals

Environmental specifications	
Operating temperature	-25 to 55°C
Storage and shipping temperature	-25 to 70°C
Relative humidity	Standard: 75% RH - Tropicalized: 95% RH
Fire behavior	V0

Standards and reference values	
EN 61810-1, EN 61810-2, EN 61810-7 EN 60695-2-10 EN 61000 EN 60529	Electromechanical elementary relays Fire behavior Electromagnetic compatibility Degree of protection provided by enclosures

Unless otherwise specified, products are designed and manufactured according to the requirements of the European and International standards indicated above.
In accordance with EN 61810-1, all items of technical data are referred to ambient temperature 23 °C, atmospheric pressure 96kPa and 50% humidity.
Tolerance for coil resistance, nominal electrical input and nominal power is ±7%.

Configurations - Options	
TROPICALIZATION	Surface treatment of the coil with protective coating for use with RH 95%.
GOLD PLATING	Surface treatment of contacts, blades and output terminals with gold-cobalt, thickness ≥ 2μ. This treatment ensures long-term capacity of the contact to conduct lower currents.
LED	Luminous indicator showing presence of power supply, wired in parallel with the coil, as alternative to mechanical optical indicator.
FLYBACK DIODE	Component connected in parallel with the coil (type 1N4007) designed to suppress overvoltages generated by the coil when de-energized.
LEVER FOR MANUAL OPERATION	Allows manual operation of the relay, with the cover closed, using a screwdriver.

Ordering scheme								
Code produit	Application ⁽¹⁾	Configuration A	Configuration B	Label	Type of power supply	Nominal voltage (V) ⁽²⁾	Finish ⁽³⁾	Keying position code ⁽⁴⁾
RMM	E: Energy F: Railway Fixed Equipment	1: Standard 3: Diode // 4: Gold plating 5: Led 6: Gold plating + Diode // 7: Diode // + Led	2: 8 CO contacts 3: 12 CO contacts 4: 20 CO contacts 6: 8 CO contacts with magnetic arc blow-out 7: 12 CO contacts with magnetic arc blow-out 8: 20 CO contacts with magnetic arc blow-out	F	C: Vdc A: Vac 50 Hz H: Vac 60 Hz	012 - 024 - 048 110 - 125 - 132 144 - 220 - 230 380 - 440	T: Tropicalized coil M: Manual operation ⁽⁵⁾	xxx

Example	RMM	E	4	7	F	A	024	M		
	RMM E47F-A024/M = ENERGY series relay with 20 gold-plated contacts, magnetic arc blow-out, 24Vac coil and manual operating lever.									
	RMM	F	1	3	F	C	110	T		
RMM F13F-C110/T = RAILWAY series relay, fixed equipment, 12 contacts with 110Vdc tropicalized coil.										

(1) ENERGY : all applications except for railway.

RAILWAYS, FIXED EQUIPMENT: application on fixed power systems and electrical railway traction. For list of RFI compliant and type-approved products, consult dedicated catalog "RAILWAY SERIES – RFI APPROVED".

Also available is the STATIONS series, with ENEL approved material meeting LV15/LV16 specifications. For list of ENEL compliant and type-approved products, consult dedicated catalog "STATIONS SERIES – LV15-LV16-LV20".

(2) Other values on request. Voltages 380V and 440V available as Vac only.

(3) Optional value. Multiple selection possible (e.g. TM).

(4) Optional value. Positive mechanical keying is applied according to the manufacturer's product model.

(5) With manual operation, no optical indicator.

Wiring diagram

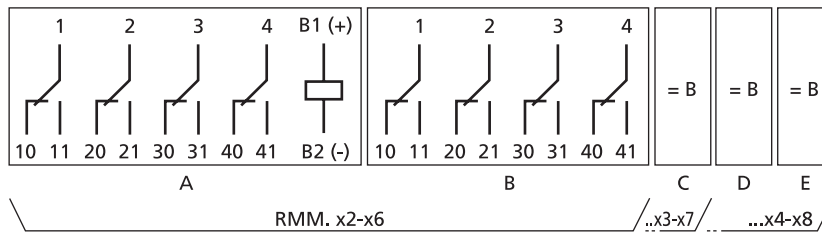

Dimensions

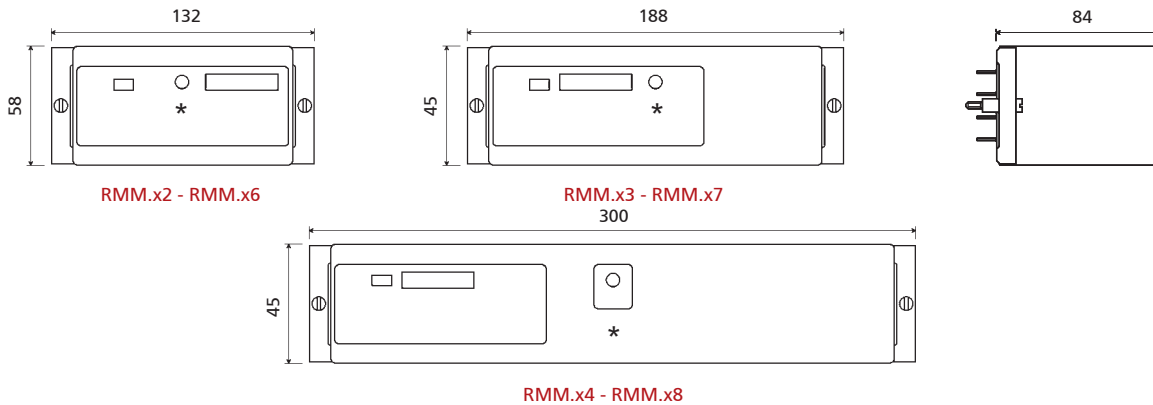

(*) Models with manual operating lever (optional) are provided with a hole at the front giving access to the lever. The position of the data plate holder and the mechanical optical indicator can vary depending on the version.

Electrical life expectancy

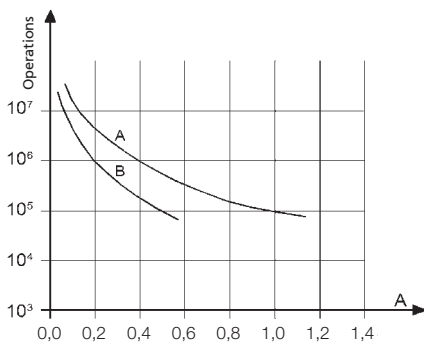

Contact loading: 110Vdc, L/R 40 ms
 Curve A: RMM.x6-7-8
 Curve B: RMM.x2-3-4

RMM.x2 - RMM.x3 - RMM.x4			
U	I (A)	L/R (ms)	Operations
110 Vdc	0.5	40	100,000
110 Vdc	0.6	10	300,000
120 Vdc	0.7	40	50,000
125 Vdc	1.2	0	1,000,000
220 Vdc	0.1	40	100,000
220 Vdc	0.25	10	100,000
U	I (A)	cosφ	Operations
110 Vac	1	1	2,000,000
110 Vac	1	0.5	1,500,000
110 Vac	5	1	1,000,000
110 Vac	5	0.5	500,000
220 Vac	0.5	1	2,000,000
220 Vac	1	0.5	600,000
220 Vac	5	1	650,000
220 Vac	5	0.5	600,000

RMM.x6 - RMM.x7 - RMM.x8			
U	I (A)	L/R (ms)	Operations
24 Vdc	1	0	7,000,000
24 Vdc	1	40	3,000,000
24 Vdc	2	40	2,000,000
24 Vdc	5	0	3,000,000
24 Vdc	5	40	200,000
24 Vdc	9	0	800,000
U	I (A)	cosφ	Operations
48 Vdc	5	20	200,000
110 Vdc	0.4	40	1,000,000
110 Vdc	1	40	100,000
110 Vdc	10	0	100,000
U	I (A)	cosφ	Operations
220 Vac	5	0.5	100,000
220 Vac	10	1	100,000
230 Vac	1	0.7	2,500,000
230 Vac	3	0.7	1,200,000

Switching frequency: 1,200 operations/hour

Sockets		RMM.x2-x6	RMM.x3-x7	RMM.x4-x8
Type of installation	Type of outputs			
Wall or DIN H35 rail mounting	Screw	PAVM321	PAVM481	PAVM801
Flush mounting	Double faston (4.8 x 0.8 mm)	PRDM321	PRDM481	PRDM801
	Screw	PRVM321	PRVM481	PRVM801

Mounting tips

The preferred mounting position is on the wall, with the relay positioned horizontally in the reading direction on the nameplate. For correct use of the relays, they should be spaced apart by at least 20 mm in the vertical direction. This is to allow correct upward dissipation of the heat generated by the coil. Set these distances according to the socket used. Distances can be reduced depending on the environmental conditions during operation, and on the relay duty cycle. Retaining clips are not required, as a secure connection is guaranteed by the fixing screws. These same screws also serve to facilitate installation and removal of the relay. To ensure correct use, the screws must be tightened / loosened in alternating sequence, by degrees. No special maintenance is required. Condensation can form inside the relay when powered up and the outside ambient temperature is cold; this is quite normal and does not affect the operation of the relay. The plastic materials of the relay do not possess hygroscopic properties.



RELAYS

INSTANTANEOUS MONOSTABLE RELAY 2-4-6-8-12 CONTACTS

POK SERIES

USER SECTORS



Power generation



Nuclear



Power transmission



Rolling stock



Fixed railway installations



Shipbuilding



Petroleum industry



Heavy industry



POK



BIPOK



TRIPOK



QUADRIPOK

PRODUCT ADVANTAGES

- Compact plug-in monostable instantaneous relays
- Solid and rugged construction for heavy or intensive duty
- Long life expectancy
- Independent and self-cleaning contacts
- Separate arc breaking chambers
- Magnetic arc blow-out standard
- Excellent shock and vibration resistance
- Option for use in geothermal sites available
- Also available in current-monitoring version
- Also available in PCB-mount version
- Wide variety of configurations and customizations
- Wide range of sockets
- Retaining clip for secure locking of relay on socket
- Transparent cover, pull-out handle
- Positive mechanical keying for relay and socket

DESCRIPTION

The POK series is made up of 5 basic models, created from a single module with 2 contacts that can be used in multiple combinations to provide solutions with 2 - 4 - 6 - 8 and 12 change-over contacts.

The construction of the relays and careful choice of the materials are such that they ensure long life and considerable ruggedness even in harsh operating environments and in the presence of strong temperature fluctuations.

A specific treatment (P5GEO or P6GEO) combining coil tropicalization with gold-plated contacts allows the use of these items in geothermal electric power stations, as relays for signalling functions, for controlling intermediate devices and for all non-power circuits.

Excellent electrical and mechanical performance levels allow the product to be used in the most demanding of sectors such as, for example, control and signalling functions in electricity generating stations, electrical transformer stations, rail transport or in industries with continuous production processes (chemical industry, petroleum industry, rolling mills, cement factories, etc.).

Above all, the excellent ability to withstand shock and vibration allow their use on rolling stock.

Safe and reliable operation is guaranteed by:

- **Contact terminals without connecting braids and soldered joints.** The terminals connecting with the socket are provided by a direct extension of the contacts.
- Mechanism without return springs.
- Adoption of all-metallic operating mechanism, unaffected by the thermal ageing that typically degrades organic materials, such as plastics.
- Excellent shock and vibration resistance.
- Notable resistance to high operating temperatures and high thermal shocks.

The self-cleaning contacts are independent, being anchored neither one to another nor to a common operating mechanism. Positioned in separate chambers, they enable better breaking of the arc.

In addition, they are equipped with magnetic arc blowout, guaranteeing a particularly efficient break of direct current loads. The common contact is mounted to a separate return device, consisting in a flexible blade designed to ensure uniformity of the pressures on break contacts. Given their dimensions and specifications, POK relays provide the logical complement to power relays of the OK series.

Models	Number of contacts	Nominal current	Rolling stock application
POK	2	5 A	•
POKS	2	10 A	•
BIPOK	4	5 A	•
BIPOKS	4	10 A	•
TRIPOK	6	5 A	•
TRIPOKS	6	10 A	•
QUADRIPOKS	8	10 A	•
ESAPOKS	12	10 A	•

FOR CONFIGURATION OF PRODUCT CODE, SEE "ORDERING SCHEME" TABLE

Coil specifications	POK - POKS	BIPOK - BIPOKS	TRIPOK - TRIPOKS	QUADRIPOKS	ESAPOKS
Nominal voltages Un ⁽¹⁾	DC: 12-24-36-48-72-96-110-125-132-144-220 AC : 12-24-48-110-127-220-230				
Max. consumption at Un (DC/AC)	2.5 W / 3.5 VA	3W / 4 VA	3.5 W / 5.5 VA	6 W / 8 VA	7 W / 11 VA
Operating range ⁽¹⁾	DC: 80...115% Un AC: 85...110% Un				
Rolling stock version ^{(2) (3)}	DC : 70...125% Un				
Type of duty	Continuous				
Drop-out voltage ⁽⁴⁾	DC: > 5% Un AC: > 15% Un				

1. Other values on request. For ESAPOKS, values > 24V.
2. See "Ordering scheme" table for order code.
3. For operating ranges different to that specified by EN60077, refer to table "Railways, rolling stock - Special operating ranges".
4. Limit value for supply voltage, expressed as % of the nominal value, beneath which the relay is certainly de-energized.

Contact specifications	POK - POKS	BIPOK - BIPOKS	TRIPOK - TRIPOKS	QUADRIPOKS	ESAPOKS
Number and type	2 CO,form C	4 CO,form C	6 CO,form C	8 CO,form C	12 CO,form C
	POK - BIPOK - TRIPOK			POKS - BIPOKS - TRIPOKS - QUADRIPOKS - ESAPOKS	
Current	Nominal ⁽¹⁾			10 A	
	Maximum peak (1 min) ⁽²⁾			20 A	
	Maximum pulse (10 ms) ⁽²⁾			150 A	
Example of electrical life expectancy ⁽³⁾	1800 operations/h			1 A - 110 Vdc - L/R 0 ms: 10 ⁵ operations	
	0.2 A - 110 Vdc - L/R 40 ms: 10 ⁵ operations			0.5 A - 110 Vdc - L/R 40 ms: 10 ⁵ operations	
	0.7 A - 110 Vdc - L/R 0 ms: 10 ⁵ operations			1 A - 110 Vdc - L/R 0 ms: 10 ⁵ operations	
Minimum load	Standard contacts				
	500 mW (20 V, 20 mA)				
	Gold-plated contact P4GEO ⁽⁴⁾				
	100 mW (10 V, 5 mA)				
	Gold-plated contact P8 ⁽⁴⁾				
	50 mW (5 V, 5 mA)				
Maximum breaking voltage	250 Vdc / 350 Vac				
Contact material	AgCu			Ag / AgCu	
Operating time at Un (ms) ^{(5) (6)}	DC - AC				
	Pick-up (NO contact closing)				
	≤ 20 - ≤ 20	≤ 25 - ≤ 25	≤ 25 - ≤ 25	≤ 25 - ≤ 25	≤ 25 - ≤ 25
	Drop-out (NC contact closing)				
	≤ 15 - ≤ 20	≤ 20 - ≤ 40	≤ 20 - ≤ 45	≤ 20 - ≤ 40	≤ 20 - ≤ 45

1. On all contacts simultaneously, reduction of 30%.
2. The max. peak and pulse currents are those currents that can be handled, for a specified time, by the contact. They do not refer to steady or interrupted currents.
3. For other values, see electrical life expectancy curves.
4. Specifications of contacts on new relay
 - a. Plating material: **P4GEO**: gold-nickel alloy (>6μ) **P8**: gold-cobalt alloy (>5μ), knurled contact
 - b. When the gold-plated contact is subject to heavy loads, it will be degraded on the surface. In this case, the characteristics of the standard contact should be taken into consideration. This does not impair relay operation.
5. Unless specified otherwise, the operating time signifies until stabilization of the contact (including bounces).
6. Addition of a flyback diode connected in parallel with the coil (DC version only) causes an increase in operating time when the relay drops out.

Insulation	
Insulation resistance (at 500 Vdc)	
between electrically independent circuits and between these circuits and ground	> 1,000 MΩ
between open contact parts	> 1,000 MΩ
Withstand voltage at industrial frequency	
between electrically independent circuits and between these circuits and ground	2 kV (1 min) - 2.2 kV (1 s)
between open contact parts	1 kV (1 min) - 1.1 kV (1 s)
between adjacent contacts	2.5 kV (1 min) - 3 kV (1 s)
Impulse withstand voltage (1.2/50μs - 0.5J)	
between electrically independent circuits and between these circuits and ground	5 kV
between open contact parts	3 kV



Mechanical specifications

Mechanical life expectancy		DC: 20 x 10 ⁶ AC: 10 x 10 ⁶ operations			
Maximum switching rate Mechanical		3,600 operations / hour			
Degree of protection (with relay mounted)		IP40			
	POK-POKS	BIPOK-BIPOKS	TRIPOK-TRIPOKS	QUADRIPOKS	ESAPOKS
Dimensions (mm) ⁽¹⁾	20 x 50 x 45	40 x 50 x 45	60 x 50 x 45	80 x 61 x 45	120 x 50 x 45
Weight (g)	~ 90	~ 170	~ 250	~ 340	~ 520

1. Excluding output terminals



Environmental specifications

Operating temperature	Standard	-25° to +55°C
	Version for railways, rolling stock	-25° to +70°C
Storage and shipping temperature		-50° to +85°C
Relative humidity		Standard: 75% RH - Tropicalized: 95% RH 5 g - 10 to 55 Hz - 1 min
Resistance to vibrations		20 g - 11 ms
Resistance to shock		V0
Fire behavior		



Standards and reference values

EN 61810-1, EN 61810-2, EN 61810-7 EN 60695-2-10 EN 61000 EN 60529	Electromechanical elementary relays Fire behavior Electromagnetic compatibility Degree of protection provided by enclosures
---	--

Unless otherwise specified, the products are designed and manufactured according to the requirements of the above-mentioned European and International standards. In accordance with EN 61810-1, all items of technical data are referred to ambient temperature 23 °C, atmospheric pressure 96kPa and 50% humidity. Tolerance for coil resistance, nominal electrical input and nominal power is ±7%.



Railways, rolling stock - Standards

EN 60077	Electric equipment for rolling stock - General service conditions and general rules
EN 50155	Electronic equipment used on rolling stock
EN 61373	Shock and vibration tests, Cat 1, Class B
EN 45545-2	Fire behavior, Cat E10, Requirement R26, V0
ASTM E162, E662	Fire behavior



Railways, rolling stock - Special operating ranges for POK(s) - BIPOK(s) relays ⁽¹⁾

Nominal voltage	Minimum pick-up voltage	Maximum operating voltage	Order symbol ⁽¹⁾
24 Vdc	18	33	Z01
24 Vdc	16	32	Z02
24 Vdc	16.8	32	Z03
24 Vdc	19	30	Z04
36 Vdc	28	46	Z01
72 Vdc	55	104	Z01
72 Vdc	55	96	Z02
110 Vdc	77	144	Z01

(1) To order the relay with the special operating range, indicate the "Z0x" symbol in the "Keying position" field of the ordering scheme. The special range may be subject to operating specifications different from standard specifications. Please contact us for further information.

Configuration Options

P2	Tropicalization of the coil with epoxy resin for use with 95% RH (@ T 50 °C). This treatment also protects the coil against corrosion which could occur by combination of the humidity with certain chemical agents, such as those found in acid atmospheres (typical of geothermal power stations) or saline atmospheres.
P4GEO	Gold plating of contacts with gold-nickel alloy, thickness ≥ 6μ. This treatment ensures long-term capacity of the contact to conduct lower currents in harsh ambient conditions such as acid atmospheres (typical of geothermal power stations) or saline atmospheres.
P5GEO	P4GEO gold-plating of contacts + P2 coil tropicalization.
P6GEO	P4GEO type gold-plating, but applied to contacts, contact terminals and output terminals + P2 coil tropicalization.
P7	AgCdO (silver cadmium oxide) contacts.
P8	Gold plating of contacts with gold-cobalt alloy, thickness ≥ 5μ, knurled fixed contact. This finish allows further improvement of the performance provided by gold-plated contact, compared to P4GEO treatment.
LED	LED indicator showing presence of power supply, wired in parallel with the coil.
FLYBACK DIODE	Polarized component connected in parallel with the coil (type 1N4007 or BYW56 for rolling stock version) designed to suppress overvoltages generated by the coil when de-energized.
VARISTOR	Non-polarized component connected in parallel with the coil, designed to suppress overvoltages higher than the clamping voltage, generated by the coil when de-energized.
TRANSIL	Non-polarized component connected in parallel with the coil. Behavior is similar to that of a varistor, with faster operating times.
LOW TEMPERATURE	Minimum operating temperature -50°C, only for rolling stock version (option "L").
C.S.	PCB-mount version (for POK-POKS-BIPOK-BIPOKS only).

Ordering scheme

Model	Number of CO contacts	Product code	Application ⁽¹⁾	Configuration A	Configuration B	Label	Type of power supply	Nominal voltage (V) ⁽²⁾	Keying position ⁽³⁾ / option
POK	2 - 5A	POK	E: Energy Railway Fixed Equipment	1: Standard	0: Standard	F	C: Vdc A: Vac 50 Hz H: Vac 60 Hz	012 - 024 - 036 048 - 072 - 096 100 - 110 - 125 127 - 132 - 144 220 - 230	XXX CS = PCB-mount version L = low temperature**
POKS	2 - 10A	POKS		2: Diode //	2: P2				
BIPOK	4 - 5A	BPOK		3: Varistor	4: P4 GEO				
BIPOKS	4 - 10A	BPOKS		4: Led	5: P5 GEO				
TRIPOK	6 - 5A	TPOK	R: Railway Rolling Stock*	5: Diode // + Led	6: P6 GEO				
TRIPOKS	6 - 10A	TPOKS		6: Varistor + Led	7: P7				
QUADRIPOKS	8 - 10A	QPOK		7: Transil	8: P8				
ESAPOKS	12 - 10A	EPOK		8: Transil + Led					

Example	TPOKS	E	3	0	F	A	230		
	TPOKSE30F-A230 - TRIPOKS relay, ENERGY series, nominal voltage 230 Vac, equipped with varistor								
	BPOKS	R	5	8	F	C	024		
	BPOKSR58F-C024 - BIPOKS relay, ROLLING STOCK series, nominal voltage 24 Vdc, equipped with diode, LED, with P8 finish (gold-plated contacts)								
	POK	R	1	0	F	C	110	L	
POKR10F - C110 L - POK relay, rolling stock series, nominal voltage 110 Vdc with option "L" (low temp.)									

(1) **E = ENERGY:** all applications, except for railways rolling stock.
 Suitable on energy production, transport and distribution plants, railways fixed equipment, petrochemical and heavy industry.
R = RAILWAYS, ROLLING STOCK: Application on board rolling stock (rail-tram-trolley vehicles). Electrical characteristics according to EN60077.
 Available also the product series:
RAILWAYS, FIXED EQUIPMENT: Approved and conforming relays and products to RFI (FS Group) specification no. RFI DPRIM STF IFS TE 143 A
 For the list of RFI approved and conforming products, consult dedicated catalog "RAILWAY SERIES – RFI APPROVED".
STATIONS: ENEL approved material meeting LV15/LV16 specifications.
 For the list of ENEL approved and conforming products, consult the dedicated catalog "STATIONS SERIES – LV15-LV16-LV20".
 (2) Other values on request.
 (3) Optional value. PCB-mount version available for POK - POKS - BIPOK - BIPOKS only. Multiple selection possible (e.g. CS - L). The positive mechanical keying is applied according to the manufacturer's model (not available for PCB-mount versions).
 * Except ESAPOKS
 ** Except TRIPOKS, QUADRIPOKS and ESAPOKS

Wiring diagram

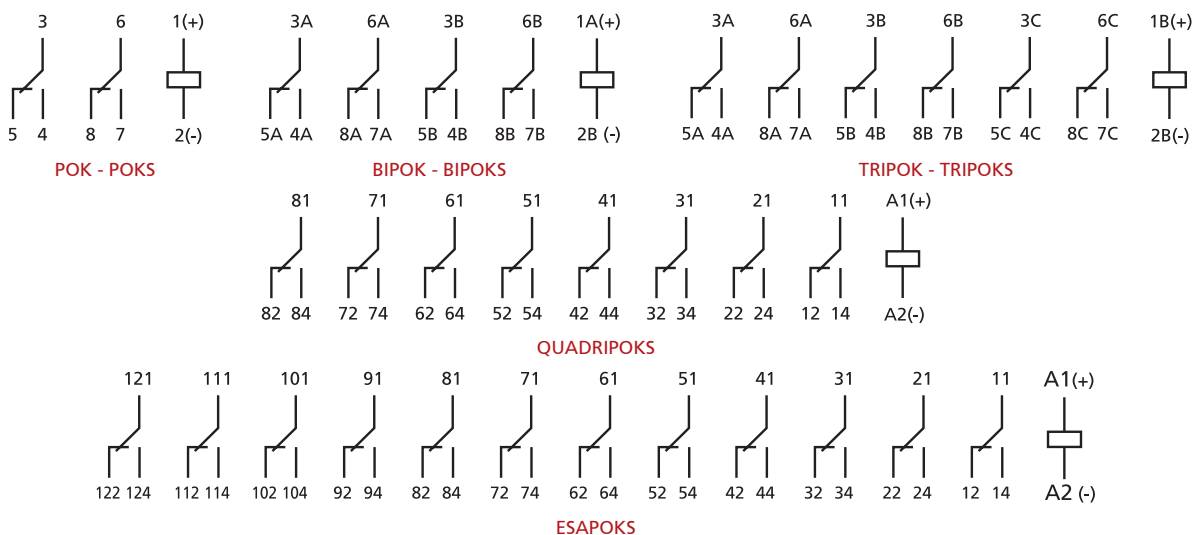

Dimensions

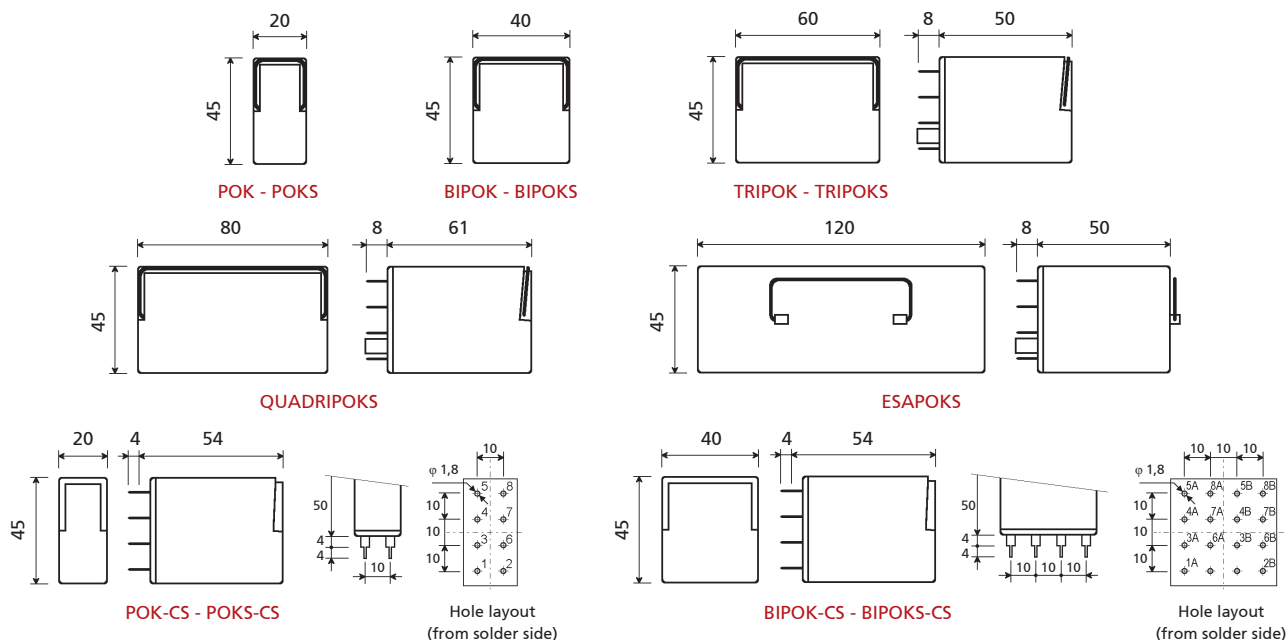

Electrical life expectancy

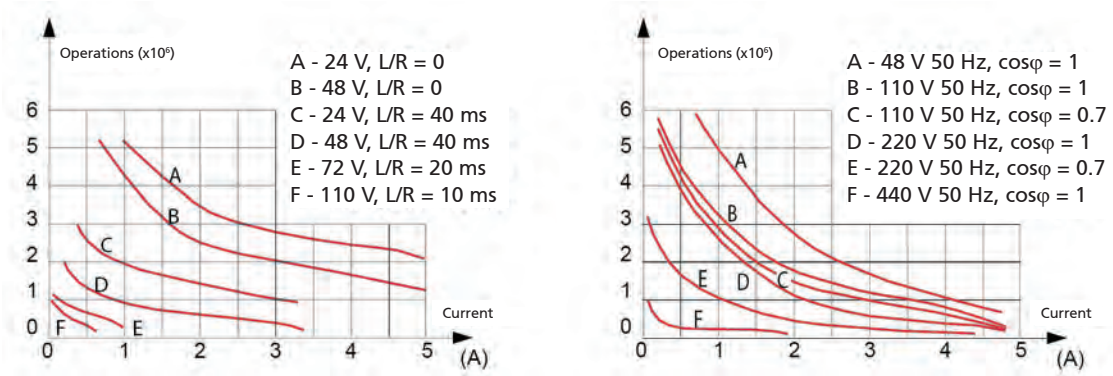

Examples of electrical life expectancy
 48 Vdc - 5 A - L/R = 10 ms : 5×10^5 operations
 80 Vdc - 5 A - Resistive : 5×10^5 operations
 110 Vdc - 0,5 A - L/R = 10 ms : 5×10^5 operations

220 Vdc - 0,2 A - L/R = 10 ms : 10^5 operations
 110 Vac - 5 A - $\cos\phi = 0.7$: 5×10^5 operations
 220 Vac - 3 A - $\cos\phi = 0.7$: 5×10^5 operations
 440 Vac - 0,2 A - Resistive : 5×10^5 operations

Sockets	POK - POKS	BIPOK - BIPOKS	TRIPOK - TRIPOKS	QUADRIPOKS	ESAPOKS
Number of terminals	8	16	24	32	48
For wall or rail mounting					
Spring clamp, wall or DIN H35 rail mounting	PAIR080	PAIR160	PAIR240	PAIR320	PAIR480
Screw, wall or DIN H35 rail mounting	50IP20-I DIN	48BIP20-I DIN	78BIP20-I DIN	96IP20-I DIN	156IP20-I DIN
Screw, wall mounting	50L	48BL	78BL	96BL	156BL
Double faston, wall mounting	51L	48L	78L	-	-
For flush mounting					
Double faston (4.8 x 0.8 mm)	ADF1	ADF2	ADF3	ADF4	ADF6
Screw	53IL	43IL	73IL	-	-
For mounting on PCB					
	65 ⁽¹⁾	65	-	-	-

(1) Suitable for mounting 2 relays side by side.

Retaining clips – correspondence with sockets	POK - POKS	BIPOK - BIPOKS	TRIPOK - TRIPOKS	QUADRIPOKS	ESAPOKS
Number of clips per relay	1	1 ⁽¹⁾	2	2	2
SOCKET MODEL	CLIP MODEL				
For wall or rail mounting					
PAIR080, PAIR160, PAIR240, PAIR320, PAIR480	RPB48	RPB48	RPB48	RQ48	RPB48
50IP20-I DIN, 48BIP20-I DIN, 78BIP20-I DIN, 96IP20-I DIN, 156IP20-I DIN	RPB48	RPB48	RPB48	RQ48	RPB48
50L, 48BL, 78BL, 96BL, 156BL	RPB48	RPB48	RPB48	RQ48	RPB48
51L, 48L, 78L	RPB48	RPB48	RPB48	-	-
For flush mounting					
ADF1, ADF2, ADF3, ADF4, ADF6	RPB48	RPB48	RPB48	RQ48	RPB48
ADF, 53IL, 43IL, 73IL ⁽²⁾	RPB43	RPB43	RPB43	-	-
For mounting on PCB					
	65	RPB43	RPB43	-	-

(1) Assume two clips for use on rolling stock.

(2) Insert the clip before fastening the socket on the panel.

Mounting tips

The preferred mounting position is on the wall, with the relay positioned horizontally in the reading direction on the nameplate. For correct use of the relays, they should be spaced apart by at least 5 mm in the horizontal direction and 20 mm in the vertical direction. This is to allow correct upward dissipation of the heat generated by the coil. Set these distances according to the socket used. Distances can be reduced depending on the environmental application conditions and on the relay duty cycle.

For safe and secure operation, it is advisable to use retaining clips.

No special maintenance is required.

Condensation can form inside the relay when powered up and the outside ambient temperature is cold; this is quite normal and does not affect the operation of the relay. The plastic materials of the relay do not possess hygroscopic properties.



RELAYS

INSTANTANEOUS MONOSTABLE RELAYS WITH 4-8-12 CONTACTS

OK SERIES

USER SECTORS



Power generation



Nuclear



Power transmission



Rolling stock



Fixed railway installations



Shipbuilding



Petroleum industry



Heavy industry



OKUIC

PRODUCT ADVANTAGES

- Plug-in monostable instantaneous relay
- Solid and rugged construction for heavy or intensive duty
- Very long electrical life expectancy and exceptional endurance
- Patent operating mechanism, designed to ensure high contact pressure
- Ample clearance between open contact elements (from 1.2 to 4 mm)
- Independent and self-cleaning contacts with high breaking capacity
- Magnetic arc blow-out for higher breaking capacity
- Excellent shock and vibration resistance
- Wide variety of configurations and customizations
- Option for use in geothermal sites available
- Wide range of sockets
- Retaining clip for secure locking of relay on socket
- Transparent cover, pull-out handle
- Positive mechanical keying for relay and socket

DESCRIPTION

The **OK series** is made up of 7 basic models, created from a **patented common operating mechanism equipped with 4 contacts**. Solutions with 8 or 12 contacts are obtainable by using 2 or 3 relays in combination.

The construction of the relays and careful choice of the materials are such that they ensure long life and considerable ruggedness even in harsh operating environments and when subject to strong thermal shocks. A **specific treatment (P5GEO or P6GEO)** combining coil tropicalization with gold-plated contacts allows the use of these items in geothermal electric power stations, as final relays for controlling field devices and for all power circuits.

The relays in the OK Series use a patented switching mechanism designed to minimize friction, resulting in a **mechanical life expectancy of at least 100,000,000 operations**.

This is made possible thanks to:

- The use of a solenoid with a core drawn in toward the main air gap, located at the centre of the coil, the only position in which the available magnetic flux can be exploited to the full
- The core motion being limited to the minimum, thereby optimizing mechanical forces and reducing friction. The motion is amplified by means of a W linkage, which allows an appreciable displacement of the contact (> 4 mm in the case of the version with NO contacts)

- The coil of elongated cylindrical geometry, best able to ensure high efficiency and effective dissipation of the heat produced.

Each contact is mounted on individual and independent blades, which are able to provide optimum shock and vibration resistance.

In particular, this generates pressure of around 0.8...1N on the make and break contacts, which is unparalleled by other products.

The common contact slides against the fixed poles (NO and NC contacts) both when opening and when closing, which ensures a notably effective self-cleaning action.

With ample clearance between the open contact elements, it becomes possible to **guarantee an impulse withstand voltage of 5 kW** between the poles of the single contact.

Excellent electrical and mechanical performance levels allow the product to be used in the most demanding of sectors such as, for example, control and signalling functions in electricity generating stations, electrical transformer stations, rail transport or in industries with continuous production processes (chemical industry, petroleum industry, rolling mills, cement factories, etc.).

Above all, the excellent ability to withstand shock and vibration allow their use in seismic environments or on rolling stock.

Description of models

There are 7 relay models in the OK Series (OK, OKS, OKFC, OKSFC, OKSCD, OKSGcCd and OKUIC). The outputs are available on 16 terminals of standard dimensions 5x0.8mm, evenly and symmetrically divided into 4 rows spaced 10mm apart, in both directions. Internal connections are ordered symmetrically. Turning the relay through 180° on its connector has the effect simply of changing the contacts, without affecting operation (except in the case of relays with a polarized power input).

OK – OKS

The OK relay offers ruggedness, easy installation, high breaking capacity (with magnetic arc blow-out, model OKS), safe operation and adaptability to any kind of circuit, making it suitable for all heavy duty applications in the field of remote control systems and automation. The distance between contacts is 2.2mm. Superior shock and vibration resistance ensures that contacts are able to hold their operating position even when exposed to a shock force of 30g - 1ms. No opening of break contacts up to 3g.

On the OKS model, a powerful magnetic arc blow-out located between the 4 change-over contacts has the effect of generating a permanent magnetic field. When an inductive load circuit is broken, the resulting arc is swiftly extended and finally extinguished through the action of the magnetic field created by the blow-out.

OKFC - OKSFC - OKUIC

The OKFC relay is an energy saving component. The distance between contacts is 1.2mm. Contact pressures and shock and vibration resistance are the same as specified for OK/OKS models. In the case of d.c. loads, the breaking capacity is reduced from that of the OK relay, although the addition of the magnetic arc blow-out (model OKSFC) provides breaking capacity of up to 15 A at 120Vdc (see example of electrical life expectancy). On the OKSFC model, a powerful magnetic arc blow-out located between the 4 change-over contacts has the effect of generating a permanent magnetic field. When an inductive load circuit is broken, the resulting arc is swiftly extended and extinguished through the action of the magnetic field created by the blow-out. With direct current, breaking capacity is doubled. For d.c. and a.c. currents that can be broken without the blow-out, the effect of having this feature available will be to reduce wear on the contacts, doubling electrical life expectancy.

The connection of 2 contacts in series increases electrical life expectancy and doubles breaking capacity when handling direct current.

The connection of 2 contacts in parallel likewise increases electrical life expectancy.

In the event that the 4 contacts are all available for breaking purposes, it is possible to use a series/parallel connection arrangement as illustrated below. In the case of high voltages, from 250V upwards, it is best to avoid breaking opposite polarities on adjacent contacts.

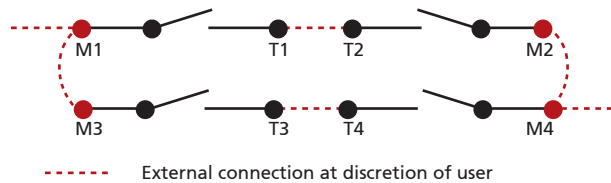

The use of the OKFC or OKSFC relay is advisable whenever the requirement is for detecting loss of voltage, hence where relays are permanently powered up, or when the ambient temperature may reach 70 °C. These relays can be powered up permanently, even at the maximum voltage of the specified operating range; they can also handle wide fluctuations in voltage and consequently are able to respond, for example, to standards for rolling stock, as in the case of the OKUIC model, which has a coil with a wide operating range.

OKSCD

The silver-coated contacts of normal relays can fuse together when closed if exposed to a peak current of 50 A for at least 5 ms. Using cadmium oxide contacts, the surfaces will fuse only at currents higher than 150 A. With magnetic arc blow-out fitted as standard to these relays, there is no possibility of the arc creating a hot spot between the contacts that could cause them to become welded together.

This relay is especially suitable for handling highly inductive direct current loads, and circuits with filament lamps where the closing of contacts can produce current peaks of up to 10 or 15 times the nominal strength (public or industrial lighting systems). It can also be used for starting small electric motors and other appliances that produce high transient currents. The OKSCD relay has an electrical life expectancy equal to that of the OKS relay, but is also suitable for use with circuits generating high transient currents, given the factors indicated above. Controlling a circuit with 600W filament lamps connected to a 110Vac supply, for example, the OKSCD relay is capable of 1,500,000 operations.

OKSGcCd

The OKSGcCd relay has a longer electrical life expectancy than the OKSCd model. It has 4 normally open contacts, and a distance between contacts of > 4mm. Magnetic arc blow-out is fitted as a standard feature. The OKSGcCd relay can be used with heavily inductive d.c. loads, where there is no need for change-over contacts.

OKB184

The OKB184 models are equipped as standard with a blow-out magnet and have low coil consumption. As these relays are K3-qualified, they are the relays of reference in the nuclear sector.



Models	Number of contacts	Continuous duty	Magnetic arc blow-out	AgCdO contacts	Long travel	Rolling stock application
OK	4 ⁽¹⁾					
OKS			•			
OKFC		•				
OKSFC		•	•			
OKSCd			•	•		
OKSGcCd			•	•	•	
OKUIC		•	•			•
OKB184			•			

1. Versions with 8 and 12 contacts available (excluding OKUIC, OKSCd and OKSGcCd).



FOR CONFIGURATION OF PRODUCT CODE, SEE "ORDERING SCHEME" TABLE



Coil specifications	OK - OKS	OKFC - OKSFC	OKSCd - OKSGcCd	OKUIC	OKB184
Nominal voltages Un ⁽¹⁾	DC: 12-24-36-48-72-110-125-132-144-220 AC: 12-24-48-110-115-127-220-230-380				48, 125 Vdc
Max. consumption at Un (DC/AC) ⁽²⁾	4.5 W / VA	3.5 W / VA	5 W / VA	3.5 W	3.5 W
Operating range ⁽¹⁾	DC: 80...110% Un AC: 85...115% Un	DC: 80...120% Un AC: 85...115% Un	DC: 80...110% Un AC: 80...110% Un	DC: 70...125% Un ⁽³⁾	DC: 80...110% Un
Type of duty	Continuous at Un ⁽⁴⁾	Continuous	Continuous at Un ⁽⁴⁾	Continuous	Continuous
Drop-out voltage ⁽⁵⁾	DC: > 5% Un AC: > 15% Un				

1. Other values on request.

2. For versions with 8 and 12 contacts, double and treble the value respectively.

3. For operating ranges different to that specified by EN60077, refer to table "OKUIC - Special Ranges".

4. Continuous duty is possible at the maximum voltage of the operating range at Tmax: 40 °C.

5. Limit value for supply voltage, expressed as % of the nominal value, beneath which the relay is certain to be de-energized.



Contact specifications	OK - OKS - OKFC - OKSFC - OKUIC - OKB184	OKSCd	OKSGcCd		
Number and type ⁽¹⁾	4 CO, form C	4 CO, form C	4 NO		
Current	Nominal ⁽²⁾	10 A			
	Maximum peak (1 min) ⁽³⁾	20 A			
	Maximum pulse (10 ms) ⁽³⁾	150 A			
Example of electrical life expectancy ⁽⁴⁾ 1,800 operations/hour	OK	0,7 A – 120 Vdc – L/R 0 ms: 5,5 x 10 ⁵ operations			
	OKS	1 A – 120 Vdc – L/R 40 ms: 5 x 10 ⁵ operations			
	OKFC	0,5 A – 110 Vdc – L/R 40 ms: 10 ⁵ operations			
	OKSFC - OKUIC	0,7 A – 132 Vdc – L/R 40 ms: 10 ⁵ operations			
	OKSCd	1 A – 120 Vdc – L/R 40 ms: 5 x 10 ⁵ operations			
	OKSGcCd	5 A – 110 Vdc – L/R 20 ms: 2 x 10 ⁵ operations			
Minimum load	Standard contacts	500 mW (20V, 20 mA)			
	Gold-plated contacts ⁽⁵⁾	200 mW (20V, 5 mA)			
Maximum breaking voltage	350 Vdc / 440 Vac				
Contact material	AgCu		AgCdO		
Operating time at Un (ms) ^{(6) (7)}	OK-OKS-OKSCd	OKFC-OKSFC	OKB184	OKSGcCd	OKUIC
	DC – AC				
	Pick-up (NO contact closing)	≤ 28 - ≤ 40	≤ 38 - ≤ 40	≤ 30	≤ 30 - ≤ 45
Drop-out (NC contact closing)	≤ 20 - ≤ 70	≤ 18 - ≤ 80	≤ 20	-	≤ 18

1. Versions with 8 and 12 CO contacts available, excluding OKUIC, OKSCd and OKSGcCd.

2. On all contacts simultaneously.

3. The max. peak and pulse currents are those currents that can be handled, for a specified time, by the contact. They do not refer to steady or interrupted currents.

4. For other values, see electrical life expectancy curves.

5. Specifications of contacts on new relay

a. Plating material: P4GEO: gold-nickel alloy (>6µ).

b. When the gold-plated contact is subject to heavy loads, it will be degraded on the surface. In such case, the characteristics of the standard contact should be taken into consideration. This does not impair relay operation.

6. Unless specified otherwise, the operating time signifies until stabilization of the contact (including bounces).

7. Addition of a flyback diode connected in parallel with the coil (DC version only) causes an increase in operating time when the relay drops out.

MONOSTABLE INSTANTANEOUS
 INSTANTANEOUS MONOSTABLE WITH FORCIBLY GUIDED CONTACTS
 BISTABLE
 FAST-ACTING MONOSTABLE (AND BISTABLE)
 TIME DELAY (ON PICK-UP OR DROP-OUT)
 TIME DELAY WITH FORCIBLY GUIDED CONTACTS
 MEASUREMENT
 SOCKET NUMBERING EXPLANATIONS
 FRONT CONNECTION
 BACK CONNECTION
 PCB MOUNT
 RETAINING CLIPS
 KEYING

Insulation

Insulation resistance (at 500Vdc)		
between electrically independent circuits and between these circuits and ground		> 1,000 MΩ
between open contact parts		> 1,000 MΩ
Withstand voltage at industrial frequency		
between electrically independent circuits and between these circuits and ground		2 kV (1 min) - 2.2 kV (1 s)
between open contact parts		2 kV (1 min) - 2.2 kV (1 s)
between adjacent contacts		2 kV (1 min) - 2.2 kV (1 s)
mpulse withstand voltage (1.2/50µs - 0.5J)		
between electrically independent circuits and between these circuits and ground		5 kV
between open contact parts		5 kV

Mechanical specifications

Mechanical life expectancy		100 x 10 ⁶ operations				
Maximum switching rate	Mechanical	3,600 operations / hour				
Degree of protection (with relay mounted)		IP20 / IP40 or IP50 as option ⁽³⁾				
Type of power supply, n°CO	VDC, 4 CO	VAC, 4 CO	VDC, 8 CO	VAC, 8 CO	VDC, 12 CO	VAC, 12 CO
Dimensions (mm) ^{(1) (2)}	45x97x45	45x109x45	91.5x97x45	91.5x109x45	138x97x45	138x109x45
Poids (g)	~ 280	~ 280	~ 590	~ 590	~ 890	~ 890

- Output terminals excluded.
- OKUIC relay: H 109mm for standard version, H 97mm for version with LED, DIODE, VARISTOR.
- To order the relay with IP40 or IP50 protection, configure the ordering code by the "Keying position" column in "Ordering scheme".

Environmental specifications

Operating temperature	OKUIC	-25° to +55°C
Storage and shipping temperature		-25° to +70°C
Relative humidity		-40° to +85°C
Resistance to vibrations		Standard: 75% RH - Tropicalized: 95% RH
Resistance to shock		5g - 10 to 60 Hz - 1 min
Fire behavior		30g - 11 ms
		V0

Standards and reference values

EN 61810-1, EN 61810-2, EN 61810-7 EN 60695-2-10 EN 50082-2 EN 60529	Electromechanical elementary relays Fire behavior Electromagnetic compatibility Degree of protection provided by enclosures
---	--

Unless otherwise specified, products are designed and manufactured according to the requirements of the European and International standards indicated above. In accordance with EN 61810-1, all items of technical data are referred to ambient temperature 23 °C, atmospheric pressure 96kPa and 50% humidity. Tolerance for coil resistance, nominal electrical input and nominal power is ±7%.

Railways, rolling stock - Standards

EN 60077 EN 50155 EN 61373 EN 45545-2 ASTM E162, E662	Electric equipment for rolling stock - General service conditions and general rules Electronic equipment used on rolling stock Shock and vibration tests, Cat 1, Class B Fire behavior, Cat E10, Requirement R26, V0 Fire behavior
---	--

Railways, rolling stock - Special operating ranges for OKUIC relay

Nominal voltage	Minimum pick-up voltage	Maximum operating voltage
24 Vdc	18	33
36 Vdc	28	48
72 Vdc	55	110
110 Vdc	77	144
128 Vdc	85	160



Configurations - Options

P2	Tropicalisation de la bobine avec une résine époxy pour une utilisation en cas d'HR à 95 % (à T 50 °C). Ce traitement protège également la bobine contre la corrosion qui pourrait résulter d'une réaction entre l'humidité et certains agents chimiques présents dans des atmosphères acides (typiques des centrales géothermiques) ou salines.
P4GEO	Gold plating of contacts with gold-nickel alloy, thickness $\geq 6\mu$. This treatment ensures long-term capacity of the contact to conduct lower currents in harsh ambient conditions such as acid atmospheres (typical of geothermal power stations) or saline atmospheres.
P5GEO	P4GEO gold-plating of contacts + P2 coil tropicalization.
P6GEO	P4GEO type gold-plating, but applied to contacts, contact terminals and output terminals + P2 coil tropicalization.
LED	LED indicator showing presence of power supply, wired in parallel with the coil.
DIODE DE ROUE LIBRE	Polarized component connected in parallel with the coil (type 1N4007 or BYW56 for rolling stock version) designed to suppress overvoltages generated by the coil when de-energized.
VARISTANCE	Non-polarized component connected in parallel with the coil, designed to suppress overvoltages higher than the clamping voltage, generated by the coil when de-energized.
TRANSIL	Non-polarized component connected in parallel with the coil. Behaviour is similar to that of a varistor, with faster operating times.
IP40	IP40 protection with "6" handle or closure with screws.
IP50	IP50 protection with "6" handle (only for 4 CO version).
8 CONTACTS	Version with 8 change-over contacts, obtained using 2 x 4 CO relay, coils connected in series.
12 CONTACTS	Version with 12 change-over contacts, obtained using 3 x 4 CO relay, coils connected in series.



To order

Product code	Number of contacts	Application ⁽¹⁾	Configuration A	Configuration B	Label	Type of power supply	Nominal voltage (V) ⁽²⁾	Keying position code ⁽³⁾
OK OKS OKFC OKSFC OKUIC OKSCd OKSGcCd	4: CO ⁽⁴⁾ 8: 8 CO 12: 12 CO	E: Energy Railway Fixed Equipment R: Railway Rolling Stock	1: Standard 2: Diode // 3: Varistor 4: Led 5: Diode // + Led 6: Varistor + Led 7: Transil 8: Transil + Led	0: Standard 2: P2 4: P4 GEO 5: P5 GEO 6: P6 GEO 7: P7 8: P8	F	C: Vdc A: Vac 50 Hz H: Vac 60 Hz	012 - 024 - 036 048 - 072 - 100 110 - 115 - 125 127 - 132 - 144 220 - 230 - 380	XXX A: IP50 B: IP40

Example

OKSFC		E	2	0	F	C	110	
OKSFC20F-C110 - OKSFC relay, ENERGY series, nominal voltage 110 Vdc, equipped with a flyback diode								

(1) **E = ENERGY:** all applications, except for railways rolling stock.

Suitable on energy production, transport and distribution plants, railways fixed equipment, petrolchemical and heavy industry.

R = RAILWAYS, ROLLING STOCK: Application on board rolling stock (rail-tram-trolley vehicles). Electrical characteristics according to EN60077.

Other product series available:

RAILWAYS, FIXED EQUIPMENT: Approved and conforming relays and products to RFI (FS Group) specification no. RFI DPRIM STF IFS TE 143 A

For the list of RFI approved and conforming products, consult dedicated catalog "RAILWAY SERIES - RFI APPROVED".

STATIONS: ENEL approved material meeting LV15/LV16 specifications.

For the list of ENEL approved and conforming products, consult the dedicated catalog "STATIONS SERIES - LV15-LV16-LV20".

(2) Other values on request. Voltage 380V available as Vac only.

(3) Optional value. The positive mechanical keying is applied according to the manufacturer's model.

(4) For the standard version with 4 contacts, the field must be left empty.

Coded products

	OKB 184	OK Sfc UIC
48 Vdc	please contact us	-
72 Vdc	-	P01 4561 93
125 Vdc	please contact us	-

Wiring diagram

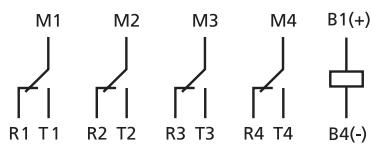

OK-OKS-OKFC-OKSFC-OKScd-OKUIC-OKB184

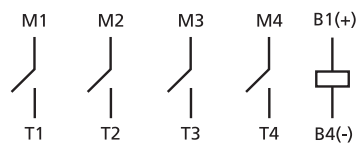

OKSGcCd

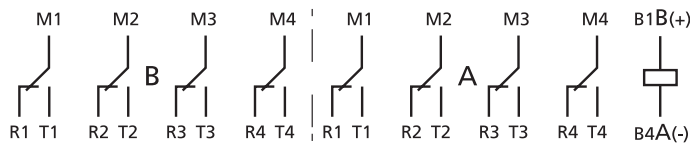

Version with 8 contacts

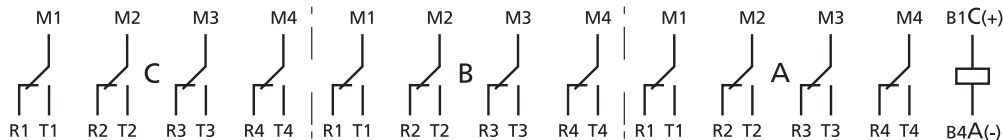

Version with 12 contacts

Dimensions

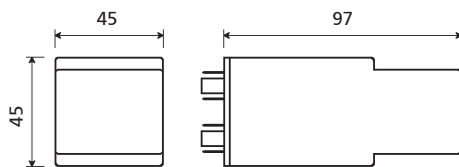

All OK d.c. relays and OKUIC with Diode and/or Led option



All a.c. OK and OKUIC relays

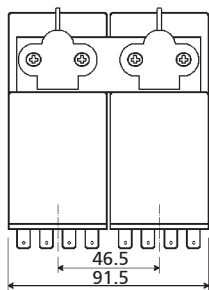

Version with 8 contacts

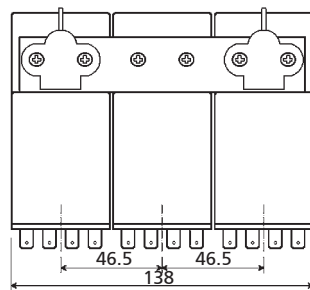

Version with 12 contacts

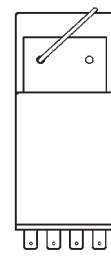

6B handle IP20 (standard)

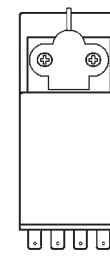

6 handle IP40 ⁽¹⁾ (OKUIC)



Closure with screws IP40 ⁽¹⁾

6 handle IP50 ⁽¹⁾

(1) IP40 or IP50 protection can requested as an option. See "Ordering scheme" for code details.

Examples of electrical life expectancy

	U (Contact)	I (A)	L/R (ms) cosφ	Operations	Notes		U (Contact)	I (A)	L/R (ms) cosφ	Operations	Notes
OK	540 Vac	3	cosφ = 0.5	15,000	②	OKFC	220 Vac	10	cosφ = 0.7	500,000	
	380 Vac	15	cosφ = 1	10,000	②		110 Vdc	0.5	L/R = 5	1,000,000	
		10	cosφ = 1	200,000			80 Vdc	1	L/R = 0	2,000,000	
		3x3.3	cosφ = 0.8	200,000			48 Vdc	5	L/R = 0	1,000,000	
	220 Vac	20	cosφ = 1	20,000	② ②	OKSFC OKUIC	120 Vdc	15	L/R = 0	100	② ③ ②
		15	cosφ = 0.5	20,000					L/R = 0	2,000,000	
		10	cosφ = 1	400,000	L/R = 10				500,000		
		3x6	cosφ = 0.8	200,000	L/R = 10				100,000		
		5	cosφ = 1	1,500,000	L/R = 10				500,000		
		5	cosφ = 1	3,000,000							
2.5		cosφ = 0.25	2,000,000								
2	cosφ = 1	15,000,000									
1.25	cosφ = 1	30,000,000									
120 Vdc	1.5	L/R = 0	550,000		80 Vdc		25	L/R = 0	100	② ②	
48 Vdc	10	L/R = 0	1,000,000	15		L/R = 20	100				
		L/R = 5	18,000,000	10		L/R = 0	400,000				
					7.5	L/R = 0	1,500,000				
					5	L/R = 10	400,000				
OKS	400 Vdc	6	L/R = 10	100	③	OKSCd	400 Vdc	6	L/R = 10	100	③
	250 Vdc	15	L/R = 0	1,000	② ② ② ②		250 Vdc	15	L/R = 0	1,000	② ② ② ②
		3	L/R = 20	300,000				3	L/R = 20	300,000	
		1	L/R = 10	30,000				1	L/R = 10	30,000	
		0.1	L/R = 15	3,500,000				1	L/R = 0	1,000,000	
	120 Vdc	30	L/R = 0	100	③ ② ② ② ② ② ②		120 Vdc	20	L/R = 0	10,000	② ②
		20	L/R = 0	10,000				10	L/R = 10	1,000	
		10	L/R = 10	1,000				10	L/R = 0	300,000	
		10	L/R = 0	300,000				5	L/R = 10	60,000	
		5	L/R = 10	60,000				1	L/R = 40	500,000	
2		L/R = 100	50,000	1		L/R = 10		1,000,000			
1		L/R = 40	500,000								
1	L/R = 10	1,000,000									
48 Vdc	10	L/R = 0	2,600,000		48 Vdc	10	L/R = 0	2,600,000			
	1.5	L/R = 5	25,000,000			3	L/R = 30	400,000			
					1.5	L/R = 5	25,000,000				
24 Vdc	30	L/R = 50	200,000	④	24 Vdc	30	L/R = 50	200,000	④		

Notes :

- ② 2 contacts connected in series
- ③ 3 contacts connected in series
- ② 2 contacts connected in parallel
- ③ 3 contacts connected in parallel
- ④ 4 contacts connected in parallel

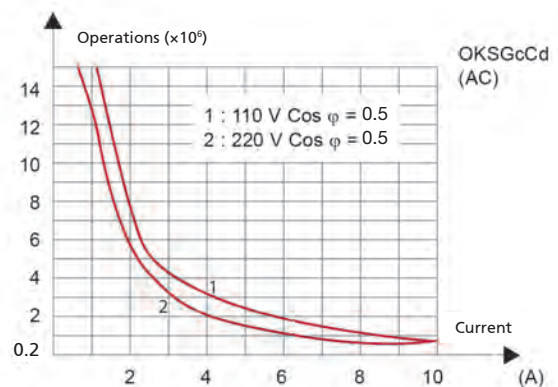
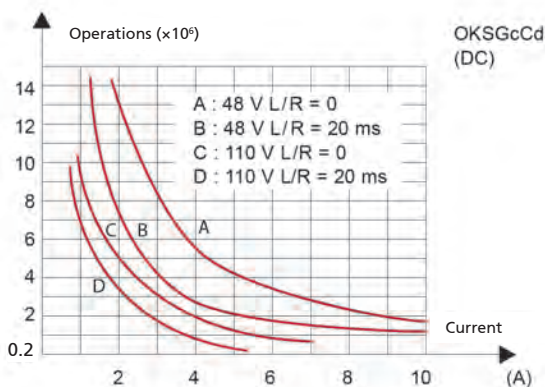
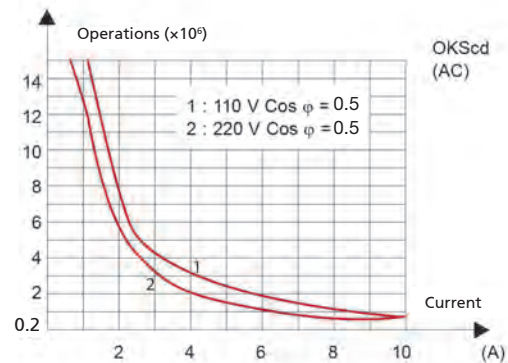
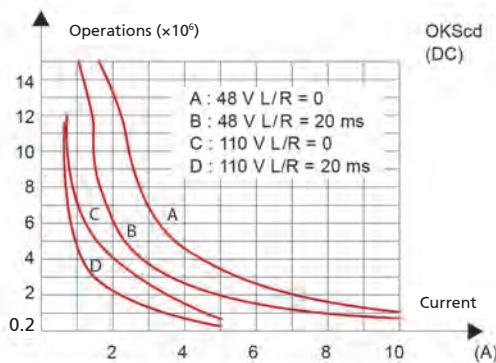
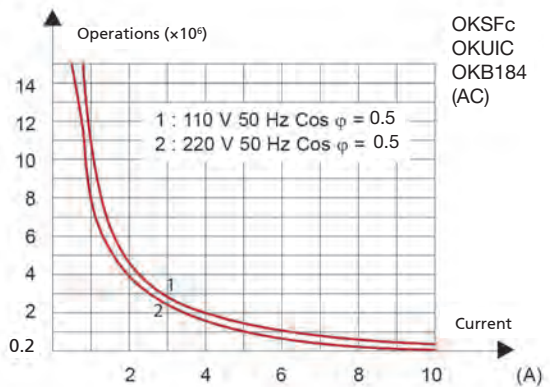
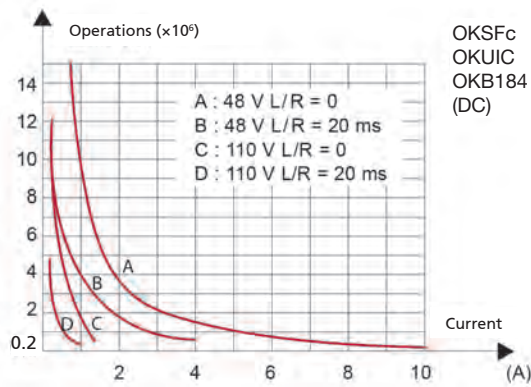
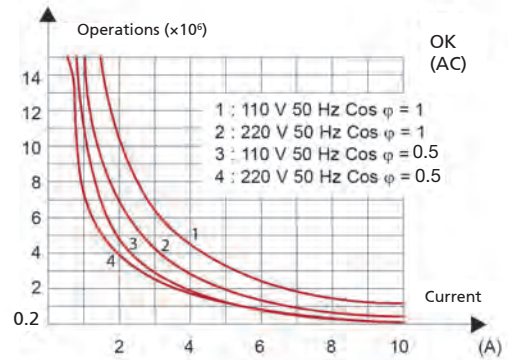
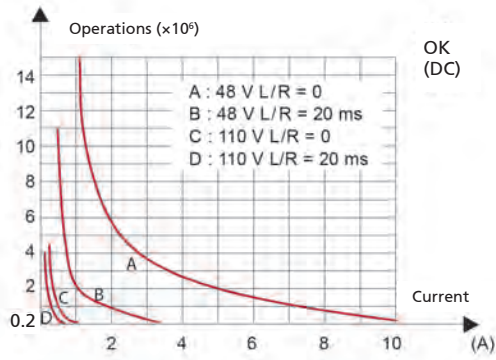

(1) Switching frequency 1,200 operations/hour, 50% cycle.

Sockets	OK series, 4 CO ⁽¹⁾
For wall or rail mounting	
Spring clamp, wall or DIN H35 rail mounting	PAIR160
Screw, wall or DIN H35 rail mounting	48BIP20-I DIN
Screw, wall mounting	48BL
Double faston, wall mounting	48L
For flush mounting	
Double faston (4.8 × 0.8 mm)	ADF2
Screw	43IL
For mounting on PCB	
	65

1) For version with 8 and 12 contacts, assume 2 and 3 sockets respectively for each relay. In this instance, the mounting distance between centres of the sockets must be 45mm. The ADF socket cannot be used.

For more details, see specifications of mounting accessories.

Retaining clips Correspondence with sockets	OK series - $V_{supply} = V_{DC}$	OK series - $V_{supply} = V_{AC}$ OKUIC	OKUIC with LED / VR / DIODE
Number of clips per relay	1, 2 for version with 8-12 CO contacts	1, 2 for version with 8-12 CO contacts and OKUIC	2
SOCKET MODEL	CLIP MODEL		
For wall or rail mounting			
PAIR160, 48BIP20-I DIN, 48BL, 48L	RC48	RL48	RC48
For flush mounting			
ADF2	RC48	RL48	RC48
43IL ⁽¹⁾	RC43	RL43	RC43
For mounting on PCB			
65	RC43	RL43	RC43

(1) Insert the clip before fastening the socket on the panel.

Mounting tips

The preferred mounting position is on the wall, with the relay positioned horizontally in the reading direction on the nameplate. For correct use of the relays, they should be spaced apart by at least 5 mm in the horizontal direction and 20 mm in the vertical direction. This is to allow correct upward dissipation of the heat generated by the coil. Set these distances according to the socket used. Distances can be reduced depending on the environmental application conditions and on the relay duty cycle.

For safe and secure operation, it is advisable to use retaining clips.

No special maintenance is required.

Condensation can form inside the relay when powered up and the outside ambient temperature is cold; this is quite normal and does not affect the operation of the relay. The plastic materials of the relay do not possess hygroscopic properties.



RELAYS

INSTANTANEOUS MONOSTABLE RELAY

RE 3000 SERIES

USER SECTORS



Power generation



Nuclear



Power transmission



Rolling Stock



Fixed railway installations



Shipbuilding



Petroleum industry



Heavy industry

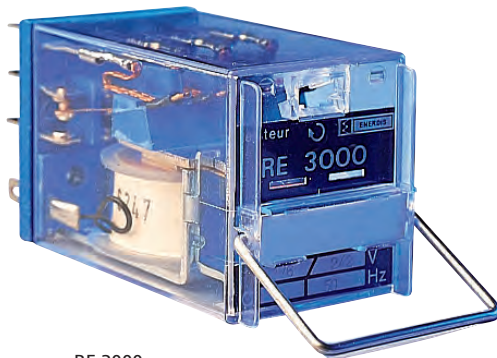

RE 3000

PRODUCT ADVANTAGES

- EDF certification for 48 Vdc and 125 Vdc
- Complies with the HM-2A/03/111/A standard
- Numerous AC and DC power supply voltages
- Breaking capacity suitable for inductive loads

DESCRIPTION

RE 3000 relays have 4 x 10 A contacts, with high reliability for intensive use in harsh conditions. The relays in the RE 3000 Series are intended for all automation applications.

Designed to operate in a harsh climatic and electrical environment, as well as in zones with high seismic constraints.

Their production quality gives them a **very long life expectancy**.

The total transparency and polished finish of the cover leave the condition of the contacts constantly visible.

The RE 3000N benefits from more a stringent manufacturing process, notably in terms of the tests performed on cleaning and measurement of the contacts' resistances.

Models	Number of contacts
RE 3000	4

SEE THE "ORDERING SCHEME" TABLE

Coil specifications	RE 3000	RE 3000 S / RE 3000 N
Nominal voltages Un ⁽¹⁾	DC: 12, 24, 30, 48, 60, 100, 110, 125, 200, 220, 250	AC: 12, 24, 48, 100/√3, 60, 110/√3, 110, 125, 220, 415/√3, 380
Max. consumption at Un (DC/AC)	< 3 W	
Operating range	80 to 110%	
Type of duty	Continuous	
Drop-out voltage ⁽²⁾	> 15%	> 10%

- For the RE 3000 N, only nominal voltages 48 and 125 are available.
- Limit value for supply voltage, expressed as % of the nominal value, beneath which the relay is certain to be de-energized.

Contact specifications	RE 3000 - RE 3000 S - RE 3000 N	
Number and type	4 CO, Form C	
Current	10 A	
Nominal ⁽¹⁾ Maximum pulse (30 ms) ⁽²⁾	250 A for 30 ms	
Minimum load	Standard contacts Gold-plated contact	
Maximum breaking voltage	250 Vdc	
Contact material	Silver	
Contact closure pressure	≥ 0.2 N	
Contact opening pressure	≥ 0.2 N	
Contact closure time	DC	≤ 45 ms
	AC	≤ 30 ms
Contact opening time	DC	≤ 25 ms
	AC	≤ 65 ms

Insulation	
Insulation resistance (at 500 Vdc)	
between the independent circuits and the ground	> 1,000 MΩ
between open contact parts	> 1,000 MΩ
Withstand voltage at industrial frequency	
between the independent circuits and the ground	2 kV (1 min)
between open contact parts	1 kV (1 min)
Impulse withstand voltage (1.2/50 μs - 0.5 J)	
between the independent circuits and the ground	5 kV
between open contact parts	5 kV



Mechanical specifications

Mechanical life expectancy		20x10 ⁶ operations
Maximum switching rate	Mechanical	3,600 operations / hour
Degree of protection (with relay mounted)		IP20
	Dimensions (mm)	45x40x103 ⁽¹⁾
	Weight (g)	200

1. Excluding the output terminals



Environmental specifications

Operating temperature	Standard	-10 ÷ +55°C
Storage and shipping temperature		-25 ÷ +70°C
Relative humidity		Standard: 65%



Standards and reference values

Resistance to vibrations (as per EN 61810)	5 g from 5 to 60 Hz (1 min)
EDF specifications	HM-2 A / 03 / 111 / A

EDF specifications	
--------------------	--

EDF application certification

EDF certification (K3/SEPTEN)	At 48 Vdc and 125 Vdc for RE 3000 N model
-------------------------------	---



Ordering scheme

Coded products				Qualified products	
RE 3000		RE 3000		RE 3000 N	
12 Vdc	RE3A 4126	24 Vac	RE3A 4107	48 Vdc	RE3A4121-CFG
24 Vdc	RE3A 4127	48 Vac	RE3A 4111	48 Vdc + Diode	RE3A4122-CFG
48 Vdc	RE3A 4131	110 Vac	RE3A 4113	125 Vdc	RE3A4125-CFG
110 Vdc	RE3A 4133	127 Vac	RE3A 4115		
127 Vdc	RE3A 4135	220 Vac	RE3A 4116		
220 Vdc	RE3A 4136	380 Vac	RE3A 4117		

Sockets and retaining clips		RE 3000 / N	Retaining clip
Type of installation	Type of outputs	Model	Retaining clip
For wall mounting	Single faston	EVL 3100	ACCA 4162
	Screw	EVV 3100	ACCA 4162
For flush mounting	Screw	EVR 3100	ACCA 4162
	Single blade	ERL 310	ACCA 4162
	Double blade	ERL 320	ACCA 4162

Mounting tips

The preferred mounting position is on the wall, with the relay positioned horizontally in the reading direction on the nameplate. For correct use of the relays, they should be spaced apart by at least 5 mm in the horizontal direction and 20 mm in the vertical direction. This is to allow correct upward dissipation of the heat generated by the coil. Set these distances according to the socket used. Distances can be reduced depending on the environmental application conditions and on the relay duty cycle.

For safe and secure operation, it is advisable to use retaining clips.

No special maintenance is required.

Condensation can form inside the relay when powered up and the outside ambient temperature is cold; this is quite normal and does not affect the operation of the relay. The plastic materials of the relay do not possess hygroscopic properties.

Wiring diagram

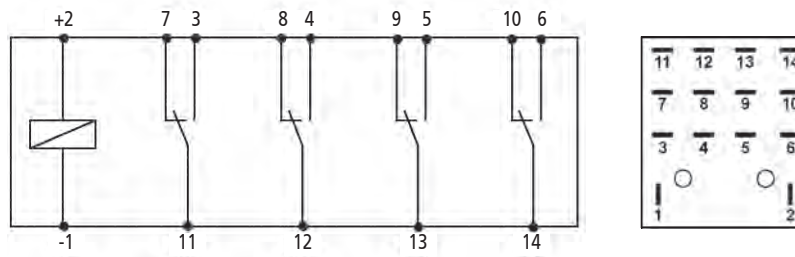

Dimensions

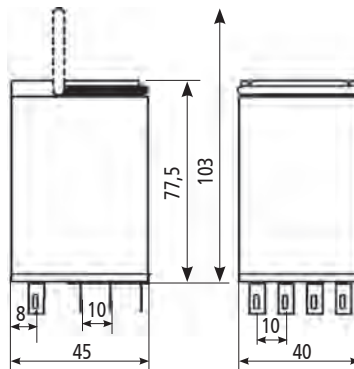

Electrical life expectancy

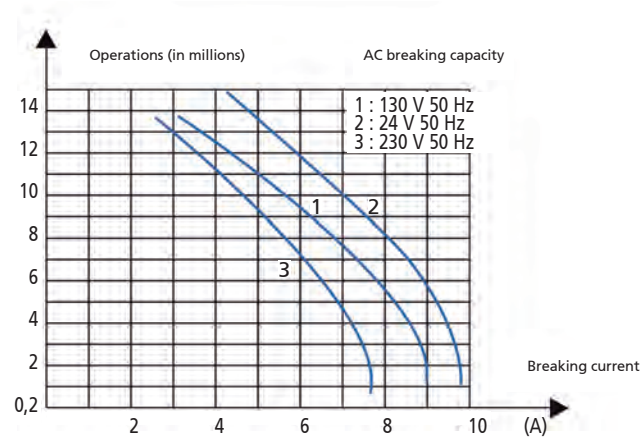
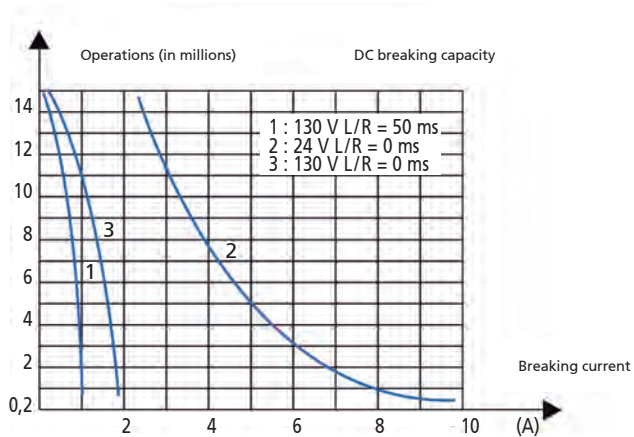



RELAYS

RAILWAY-APPROVED DOUBLE-BREAK MONOSTABLE RELAY

F-OK B SERIES

USER SECTORS



Power generation



Nuclear



Power transmission



Rolling Stock



Fixed railway installations



Shipbuilding



Petroleum industry



Heavy industry



F-OK B

PRODUCT ADVANTAGES

- 4 double-break changeover contacts / 13 A
- NF-F 62002 railway certification
- High reliability for intensive use in harsh conditions
- Long-travel contacts and excellent break reliability

DESCRIPTION

The relays in the **F-OK Series** are designed and manufactured with materials and solutions which make them particularly **long-lasting and rugged**. They are ideal for use in **difficult operating environments**, even in the event of significant thermal shocks. Thanks to their high resistance to **shocks and vibrations**, these relays are particularly suitable for use on rolling stock.

Because of the high electrical and mechanical performance provided by these relays, they can not only be used on rolling stock, but also in sectors such as **control and signaling** in railway transport or in applications with **continuous production processes**. Equipped with “**double break**” contacts, they are effective at **breaking DC loads**.

Models	Number of contacts	Nominal current
F-OK B	4	5 A

Coil specifications	F-OK B	F-OK B
Nominal voltages Un ⁽¹⁾	VDC: 24-36-48-72-96-110-125-550	VAC: 48-127-220
Max. consumption at Un (DC/AC)	< 4.8 W	< 4.8 VA
Operating range ⁽¹⁾	DC: 70...125% Un	AC: 80...110% Un
Type of duty	Continuous	
Drop-out voltage ⁽²⁾	> 10% Un	> 10% Un

1. Other values on request. For ESAPOKS, values > 24 V.

2. Limit value for supply voltage, expressed as % of the nominal value, beneath which the relay is certain to be de-energized.

Contact specifications		
Number and type	4 CO, Form Z	
Current	Nominal ⁽¹⁾	13 A
	Maximum pulse (10 ms) ⁽²⁾	300 A for 10 ms
Maximum breaking voltage	350 Vdc	
Contact material	AgNi AgCdO10	
Contact closure pressure	> 0.3 N	
Contact opening pressure	> 0.3 N	
Contact closure time	DC	≤ 55 ms
	AC	≤ 55 ms
Contact opening time	DC	≤ 25 ms
	AC	≤ 25 ms

Insulation		
Insulation resistance (at 500 Vdc) between the independent circuits and the ground between open contact parts		> 1,000 MΩ
		> 1,000 MΩ
Withstand voltage at industrial frequency between the independent circuits and the ground between open contact parts		2.5 kV (1 min)
		2 kV (1 min)

MONOSTABLE
INSTANTANEOUS

INSTANTANEOUS
MONOSTABLE WITH
FORCIBLY GUIDED
CONTACTS

BISTABLE

FAST-ACTING
MONOSTABLE
(AND BISTABLE)

TIME DELAY
(ON PICK-UP
OR DROP-OUT)

TIME DELAY WITH
FORCIBLY GUIDED
CONTACTS

MEASUREMENT

SOCKET
NUMBERING
EXPLANATIONS

FRONT
CONNECTION

BACK
CONNECTION

PCB MOUNT

RETAINING CLIPS

KEYING



Mechanical specifications

Mechanical life expectancy	100x10 ⁶ operations
Degree of protection (with relay mounted)	IP40
Dimensions (mm)	45x45x105 ⁽¹⁾
Weight (g)	300

1. Excluding output terminals



Environmental specifications

Operating temperature	Standard	-25 ÷ +70°C
Storage and shipping temperature		-40 ÷ +70°C
Relative humidity		Standard: 80%
Fire behavior		NF-F 16-101, NF-F 16-102, NF-F 62002



Standards and reference values

Resistance to vibrations (as per NF-F 62002)	2 g from 10 to 120 Hz (1 min)
Railway standards	NF-F 16-101, NF-F 16-102 (materials), NF-F 62002



Ordering scheme - Please contact us

Connection diagram and positive mechanical keying

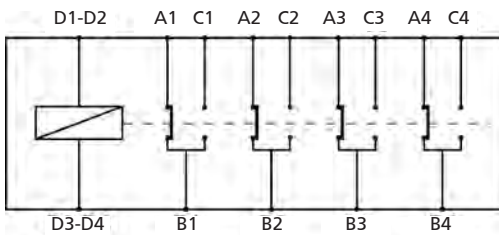

Coil voltage Keying position	Safety blank recess A	Safety blank recess B
220 Vac	C	G
24 Vdc	A	G
36 Vdc	F	L
48 Vdc	D	G
72 Vdc	B	G
72 Vdc double winding	J	F
110 Vdc	F	G
125 Vdc	E	G
550 Vdc	F	G

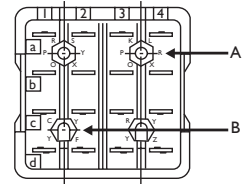

Dimensions

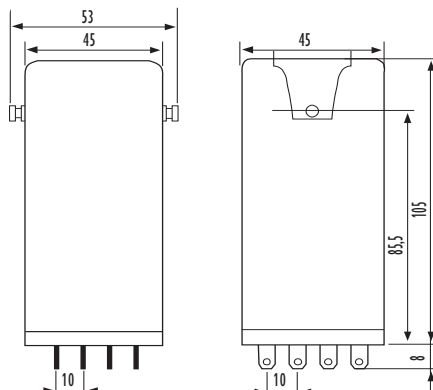

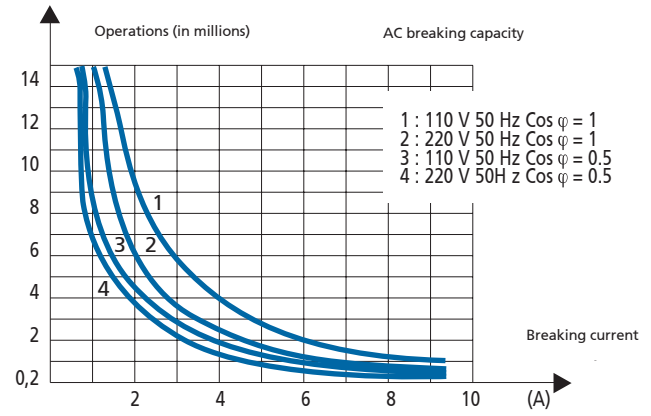
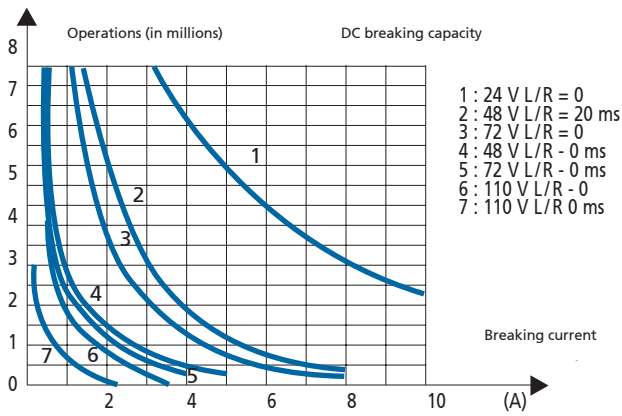

Sockets and retaining clips

Type of installation	Type of outputs	F-OK B Model	Retaining clip
For flush mounting and DIN rail	Single faston	84F	Delivered with the socket

Mounting tips

The preferred mounting position is on the wall, with the relay positioned horizontally in the reading direction on the nameplate. For correct use of the relays, they should be spaced apart by at least 5 mm in the horizontal direction and 20 mm in the vertical direction. This is to allow correct upward dissipation of the heat generated by the coil. Set these distances according to the socket used. Distances can be reduced depending on the environmental application conditions and on the relay duty cycle. For safe and secure operation, it is advisable to use retaining clips.

No special maintenance is required.

Condensation can form inside the relay when powered up and the outside ambient temperature is cold; this is quite normal and does not affect the operation of the relay. The plastic materials of the relay do not possess hygroscopic properties.

RELAYS

RELAYS

RELAYS

RELAYS

RELAYS

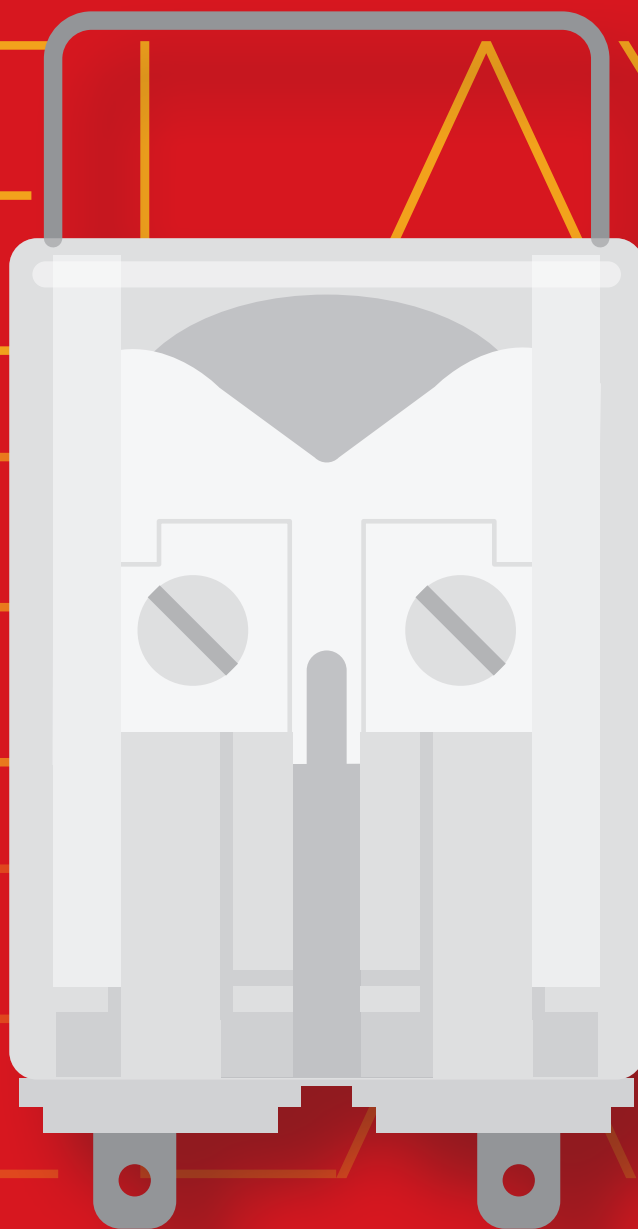

INSTANTANEOUS MONOSTABLE RELAYS WITH FORCIBLY GUIDED CONTACTS



RELAYS

INSTANTANEOUS RELAYS WITH 2-4 FORCIBLY GUIDED CONTACTS

RCG | RDG SERIES with forcibly guided contacts

USER SECTORS



Power generation



Nuclear



Power transmission



Rolling Stock



Fixed railway installations



Shipbuilding



Petroleum industry



Heavy industry



RCG



RDG

PRODUCT ADVANTAGES

- Forcibly guided (mechanically linked) contacts, relay compliant with **EN 61810-3, type A**
- Weld-no-transfer technology
- Compact plug-in monostable instantaneous relay
- Suitable for safety applications
- Solid and rugged construction for heavy or intensive duty, IP50 protection
- Self-cleaning knurled contacts
- Long electrical life expectancy
- New "HIGH POWER" magnetic arc blow-out for improved breaking capacity, as option
- Wide range of options: LED indicating power on, FLYBACK DIODE
- Retaining clip for secure locking of relay on socket
- Transparent cover, pull-out handle

DESCRIPTION

The relays in the RCG / RDG line are highly reliable products featuring high performance, suitable for applications in very harsh and disturbed environments. They are provided with **forcibly guided** (mechanically linked) contacts. The component conforms to the **EN 61810-3 requirements, type A** relay (all contacts are mechanically linked). Forcibly guided contacts are also known as weld-no-transfer contacts. A typical application is the check reading of a contact for determining, with absolute certainty, the state of the other contacts in self-monitoring control systems.

Thanks to the exceptional breaking capacity, the relay is suitable for controlling **heavy duty loads** with intensive switching frequency where safety and electrical continuity is an all-important factor.

The versatility in manufacture allows producing relays with various voltages.

The types of contacts allow obtaining remarkable performance levels both for high, inductive loads or very low loads; the optional presence of the **magnetic arc blow-out** contributes considerably to the **breaking capacity**. The knurled contacts ensure **better self-cleaning characteristics and lower ohm resistance** thanks to the various points of electrical connection, thereby **improving the electrical life** of the component.

In relays with forcibly guided (mechanically linked) or weld-no-transfer contacts, special design and constructional measures are used to ensure that make (normally-open) contacts can not assume the same state as break (normally-closed) contacts.

- If, when powering up a relay, a NC contact fails to open, the remaining NO contacts must not close, maintaining a contact gap ≥ 0.5 mm.
- When the relay is de-energized, if a NO contact fails to open, the remaining NC contact must not close, maintaining a contact gap ≥ 0.5 mm.

EN 61810-3 lays down the standard requirements for relays with forcibly guided contacts. This standard defines two types of relay with forcibly guided contacts, namely:

- Type A: Relay whose contacts are all mechanically linked (forcibly guided).
- Type B: Relay containing mechanically linked contacts and contacts which are not mechanically linked.

In the case of relays that include changeover contacts, either the make circuit or the break circuit of a changeover contact can be considered to meet the requirements of this standard.

Models	Number of contacts	Magnetic arc blow-out	HIGH POWER Magnetic arc blow-out
RCG.x2	2		
RCG.x6	2	•	
RCG.x8	2		•
RDG.x2	4		
RDG.x6	4	•	
RDG.x8	4		•

FOR CONFIGURATION OF PRODUCT CODE, SEE "ORDERING SCHEME" TABLE

Coil specifications	RCG	RDG
Nominal voltages Un	DC: 24-36-48-72-96-110-125 ⁽¹⁾	
Consumption at Un	2.2 W	2.7 W
Operating range	80 ÷ 115 % Un	
Operating range for rolling stock version ⁽²⁾	70 ÷ 125 % Un	
Type of duty	Continuous	
Drop-out voltage ⁽³⁾	DC: > 5% Un	

(1) Other values on request.

(2) See "Ordering scheme" table for order code. Suitable for application on ROLLING STOCK. Operating range in accordance with EN60077.

(3) Limit value for supply voltage, expressed as % of the nominal value, beneath which the relay is certainly de-energized.

Contact specifications	RCG	RDG		
Number and type	2 CO, form C	4 CO, form C		
Current	See the following chart 13A for 1min - 20A per 1s 100A for 10ms			
Nominal				
Maximum peak ⁽¹⁾				
Maximum pulse ⁽¹⁾				
Example of electrical life ⁽²⁾	Standard :	RCG.x2 / RDG.x2: 0.2A - 110Vdc - L/R 40ms - 5x10 ⁵ man. *		
* 1.200 oper./h	With Magnetic arc blowout:	RCG.x6 / RDG.x6: 0.5A - 110Vdc - L/R 40ms - 1.5x10 ⁵ man. *		
** 600 oper./h	With HIGH POWER Magn. arc blowout:	RCG.x8 / RDG.x8: 0.7A - 132Vdc - L/R 40ms - 7x10 ⁴ oper. **		
Minimum load	Standard contacts	100mW (10V, 5mA)		
	Gold-plated contact	50mW (5V, 5mA)		
Making capacity	30 A - 110Vdc - L/R 0 ms: 2,000 operations			
Maximum breaking voltage	250 Vdc / 300 Vac			
Contact material	AgSnO ₂ (mobile contacts) - AgNi (fixed contacts)			
Operating time at Un (ms) ⁽³⁾	Standard	Avec diode	Standard	With diode
Pick-up (NC contact opening)	≤ 13	≤ 13	≤ 17	≤ 17
Pick-up (NO contact closing)	≤ 19	≤ 19	≤ 25	≤ 25
Drop-out (NO contact opening)	≤ 4	≤ 11	≤ 4	≤ 20
Drop-out (NC contact closing)	≤ 16	≤ 25	≤ 14	≤ 34

(1) The max. peak and pulse currents are those currents that can be handled, for a specified time, by the contact. They do not refer to steady or interrupted currents.

(2) For other examples, see electrical life expectancy table.

(3) Unless specified otherwise, the operating times refer to the stabilization of the contact (including bounces).

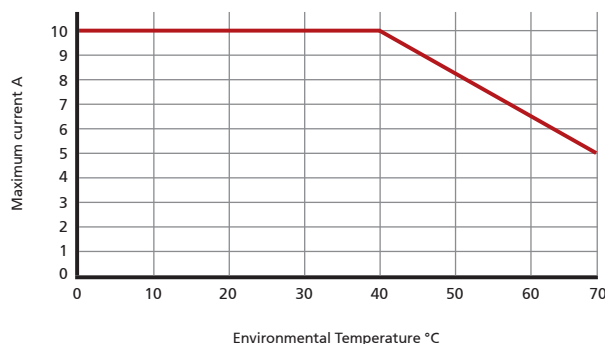



Insulation

Insulation resistance (at 500Vdc) between electrically independent circuits and between these circuits and ground between open contact parts	> 1,000 MΩ > 1,000 MΩ
Dielectric withstanding voltage at industrial frequency between electrically independent circuits and ground between coil and contacts parts between adjacent contacts between open contact parts	4 kV (1 min) 3 kV (1 min) 3.5 kV (1 min) 2 kV (1 min)
Impulse withstand (1.2/50µs - 0.5J) between electrically independent circuits and ground between open contact parts	5 kV 3 kV



Mechanical specifications

Mechanical life expectancy	20x10 ⁶ operations	
Maximum switching rate	3,600 operations / h	
Protection rating (with relay mounted)	IP50	
	RCG	RDG
Dimensions (mm)	40x20x50 ⁽¹⁾	40x40x50 ⁽¹⁾
Weight (g)	60	115

(1) Excluding output terminals



Environmental characteristics

Operating temperature Standard Version matériel Version for railways, rolling stock	-25 ÷ +55°C -25 ÷ +70°C (+85°C for 10min) -40°C as option
Storage and shipping temperature	-40 ÷ +85°C
Relative humidity	Standard: 75% RH - Tropicalized: 95% RH
Fire behavior	V0



Standards and reference values

EN 61810-1, EN 61810-7 EN 61810-3, type A EN 60695-2-10 EN 60529 EN 61000-4	Electromechanical elementary relays Relays with forcibly guided (mechanically linked) contacts, type A Fire behavior Degree of protection provided by enclosures Electromagnetic compatibility
---	--

Unless otherwise specified, the products are designed and manufactured according to the requirements of the above-mentioned European and International standards.

In accordance with EN 61810-1, all technical data are referred to ambient temperature of 23°C, atmospheric pressure of 96kPa and 50% humidity. Tolerance for coil resistance and nominal power is ±5%.



Railways, rolling stock - Standards

Railways, rolling stock - Standards	Applicable to the RCGR and RDGR series
EN 60077	Electric equipment for rolling stock - General service conditions and general rules
EN 50155	Electronic equipment used on rolling stock - T3 class
EN 61373 ⁽¹⁾	Shock and vibration tests, Cat 1, Class B
EN 45545-2	Fire behavior, HL3 : Cat E10 (Requirement R26)
ASTM E162, E662	Fire behavior

(1) only for RDGR family: permissible opening time of contacts on a de-energized relay t<100µs



Configurations - Options

TROPICALIZATION	Surface treatment of the coil with protective coating for use with RH 95%.
GOLD PLATING	Surface treatment of the contacts, blades and output terminals with gold-cobalt alloy ≥ 2µ. This treatment ensures long-term capacity of the contact to conduct lower currents.
LED	LED indicator showing presence of power supply. Flyback diode mounted as standard.
FLYBACK DIODE	Component connected in parallel to the coil (type BYW56) designed to dampen overvoltages generated by the coil when de-energized.
TRANSIL	Non-polarized component connected in parallel to the coil. Behavior is similar to that of a varistor with faster operating times.
LOW TEMPERATURE	Minimum operating temperature -40°C, only for rolling stock version (option "L").



Ordering scheme

Code produit	Application ⁽¹⁾	Configuration A	Configuration B	Label	Type of power supply	Nominal voltage (V) ⁽²⁾	Finish ⁽³⁾	Keying position code ⁽⁴⁾
RCG (2 contacts)	E: Energy	1: Standard 2: Gold plating + Diode // + Led	2: Standard					
	F: Railway Fixed Equipment	3: Diode // 4: Gold plating 6: Gold plating + Diode //	6: With magnetic arc blow-out	F	C: Vdc	024 - 036 048 - 072 096 - 110 - 125	T: Tropicalized coil L: Low temperature	XX
RDG (4 contacts)	R: Railway Rolling stock	7: Diode // + Led 8: Transil	8: With HIGH POWER magnetic arc blow-out					

Example	RCG	E	4	2	F	C	048		
	RCGE42F-C048 = ENERGY series relay with 2 CO gold-plated contacts, 48Vdc coil								
	RDG	R	1	6	F	C	110		
	RDGR16F-C110 = RAILWAY series relay, rolling stock, with 4 CO contacts, magnetic arc blow-out, 110Vdc coil								

1. **ENERGY**: all applications except for railway.

RAILWAYS, FIXED EQUIPMENT: application on fixed power systems and electrical railway traction.

Construction according to RFI (FS Group, Italy) specification n° RFI DPRIM STF IFS TE143 A, if applicable for list of RFI approved and conforming products, consult dedicated catalog "RAILWAY SERIES - RFI APPROVED"

RAILWAYS, ROLLING STOCK: application on board rolling stock. Electrical characteristics according to EN60077.

2. Other values on request.

3. Optional value.

4. Optional value. The positive mechanical keying is applied according to the manufacturer's model.

Wiring diagram

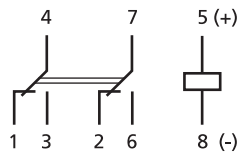

RCG

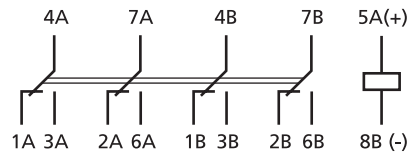

RDG

Dimensions

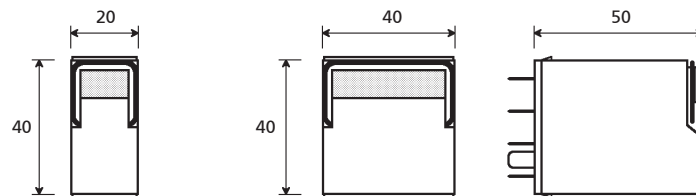

RCG

RDG

Electrical life expectancy

Some examples of electrical life expectancy.

RCG.12, RDG.12 (without magnetic arc blow-out)			
U	I (A)	L/R (ms)	Operations
110Vdc	0.2	40	500,000
220Vdc	0.2	10	80,000
U	I (A)	cosφ	Operations
110Vac	1	1	1,200,000
110Vac	1	0.5	1,000,000
110Vac	5	1	500,000
110Vac	5	0.5	300,000
220Vac	0.5	1	1,200,000
220Vac	1	0.5	500,000
220Vac	5	1	400,000
220Vac	5	0.5	300,000

RCG.16, RDG.16 (with magnetic arc blow-out)			
U	I (A)	L/R (ms)	Operations
110Vdc	0.2	40	1,000,000
110Vdc	0.5	40	150,000
110Vdc	0.6	10	300,000
110Vdc	1	10	100,000
220Vdc	0.2	10	100,000
U	I (A)	cosφ	Operations
110Vac	1	1	2,000,000
110Vac	1	0.5	1,500,000
110Vac	5	1	950,000
110Vac	5	0.5	500,000
220Vac	0.5	1	2,000,000
220Vac	1	0.5	800,000
220Vac	5	1	600,000
220Vac	5	0.5	500,000

RCG.18, RDG.18 (with HIGH POWER magnetic arc blow-out)			
U	I (A)	L/R (ms)	Operations
24Vdc	1	0	5,100,000
24Vdc	2	0	3,900,000
24Vdc	3	0	2,900,000
24Vdc	4	0	2,600,000
24Vdc	5	0	2,200,000
24Vdc	1	20	2,700,000
24Vdc	2	20	2,100,000
24Vdc	3	20	1,500,000
24Vdc	3.5	20	1,000,000
24Vdc	1	40	2,000,000
24Vdc	2	40	1,500,000
24Vdc	3	40	1,100,000
24Vdc	3.5	40	800,000
110Vdc	0.3	0	1,000,000
110Vdc	0.5	0	700,000
110Vdc	1	0	190,000
110Vdc	0.3	20	450,000
110Vdc	0.5	20	260,000
110Vdc	1	20	100,000
110Vdc	0.3	40	300,000
110Vdc	0.5	40	180,000
110Vdc	0.6	40	150,000
110Vdc	0.7	40	100,000
132Vdc	0.7	40	70,000

Switching frequency: 1,200 operations/hour.

Sockets and retaining clips		RCG	RDG	Retaining clip
Type of installation	Type of outputs	Model	Model	Retaining clip
Wall or DIN H35 rail mounting	Spring clamp	PAIR080	PAIR160	VM1831
	Screw	50IP20-I DIN	48BIP20-I DIN	VM1831
Flush mounting	Spring clamp	PRIR080	PRIR160	VM1831
	Double faston (4.8 × 0.8 mm)	ADF1	ADF2-BIPOK	VM1831
PCB-mount	Solder	65 ⁽¹⁾	65	VM1841

(1) Suitable for mounting 2 relays side by side.

Mounting tips

The preferred mounting position is on the wall, with the relay positioned horizontally in the reading direction on the nameplate. For correct use of the relays, they should be spaced apart by at least 5 mm in the horizontal direction and 20 mm in the vertical direction. This is to allow correct upward dissipation of the heat generated by the coil. Set these distances according to the socket used. Distances can be reduced depending on the environmental application conditions and on the relay duty cycle. For maximum reliability in operation, it is advisable to use retaining clips. No special maintenance is required. Condensation can form inside the relay when powered up and the outside ambient temperature is cold; this is quite normal and does not affect the operation of the relay. The plastic materials of the relay do not possess hygroscopic properties.



RELAYS

INSTANTANEOUS RELAYS WITH 4 FORCIBLY GUIDED CONTACTS

RGG SERIES with forcibly guided contacts

USER SECTORS



Power generation



Nuclear



Power transmission



Rolling Stock



Fixed railway installations



Shipbuilding



Petroleum industry



Heavy industry



RGG

PRODUCT ADVANTAGES

- Forcibly guided (mechanically linked) contacts, relay compliant with **EN 61810-3, type A**
- Weld-no-transfer technology
- Plug-in monostable instantaneous relay
- Suitable for safety applications
- Solid and rugged construction for heavy or intensive duty
- Self-cleaning knurled contacts
- Very long electrical life expectancy and exceptional endurance
- Magnetic arc blow-out for higher breaking capacity
- Wide range of options: LED indicating power on, FLYBACK DIODE
- Retaining clip for secure locking of relay on socket
- Transparent cover, pull-out handle

DESCRIPTION

The relays in the RGG line are highly reliable products featuring high performance, suitable for applications in very harsh and disturbed environments. They are provided with forcibly guided (mechanically linked) contacts. The component conforms to the **EN 61810-3** requirements, **type A relay** (all contacts are mechanically linked). Forcibly guided contacts are also known as weld-no-transfer contacts. A typical application is the check reading of a contact for determining, with absolute certainty, the state of the other contacts in self-monitoring control systems.

Thanks to the exceptional breaking capacity, the relay is suitable for controlling heavy duty loads with intensive switching frequency where safety and electrical continuity is an all-important factor.

The versatility in manufacture allows producing relays with any voltage in the range 12 to 230VDC and with a great number of operating ranges adaptable to the various application requirements.

The types of contacts allow obtaining remarkable performance levels both for high, very inductive loads or very low loads; the optional presence of the magnetic arc blow-out contributes considerably to the breaking capacity. The knurled contacts ensure better self-cleaning characteristics and lower ohmic resistance thanks to the various points of electrical connection, thereby improving the electrical life of the component.

In relays with forcibly guided (mechanically linked) or weld-no-transfer contacts, special design and constructional measures are used to ensure that make (normally-open) contacts can not assume the same state as break (normally-closed) contacts.

- If, when powering up a relay, a NC contact fails to open, the remaining NO contacts must not close, maintaining a contact gap ≥ 0.5 mm.
- When the relay is de-energized, if a NO contact fails to open, the remaining NC contact must not close, maintaining a contact gap ≥ 0.5 mm.

EN 61810-3 lays down the standard requirements for relays with forcibly guided contacts. This standard defines two types of relay with forcibly guided contacts, namely:

- Type A: Relay whose contacts are all mechanically linked (forcibly guided).
- Type B: Relay containing mechanically linked contacts and contacts which are not mechanically linked.

In the case of relays that include changeover contacts, either the make circuit or the break circuit of a changeover contact can be considered to meet the requirements of this standard.

Models	Number of contacts	Magnetic arc blow-out
RGG.x3X	4	
RGG.x7X	4	•

FOR CONFIGURATION OF PRODUCT CODE, SEE "ORDERING SCHEME" TABLE

Coil specifications	RGGExyX / RGGFxyX	RGGRxyX ⁽³⁾
Nominal voltages Un	DC: 12-24-48-110-125-132-144-230 ⁽¹⁾	DC: 24-36-72-110 ⁽¹⁾
Consumption at Un (DC/AC)	3,5W	
Operating range	80...120% Un	70...125% Un
Type of duty	Continuous	
Drop-out voltage ⁽²⁾	DC: > 5% Un	

(1) Other values on request.

(2) Limit value for supply voltage, expressed as % of the nominal value, beneath which the relay is certainly de-energized.

(3) Suitable for application on ROLLING STOCK. Operating range in accordance with EN60077.

Contact specifications

Number and type		4 CO, form C
Current	Nominal ⁽¹⁾	12A
	Maximum peak ⁽²⁾	20A for 1min - 40A for 1s
	Maximum pulse ⁽²⁾	150A for 10ms
Example of electrical life expectancy ⁽³⁾		RGG.x3: 0.5A - 110Vdc - L/R 40ms - 10 ⁵ Manœuvres - 1,800 operations/hour RGG.x7: 1A - 110Vdc - L/R 40ms - 10 ⁵ Manœuvres - 1,800 operations/hour 1A - 110Vdc - L/R 40ms - 2x10 ⁵ Manœuvres - 600 operations/hour
Minimum load	Standard contacts	200mW (10V, 10mA)
	Gold-plated contact	50mW (5V, 5mA)
Maximum breaking voltage		350 VDC / 440 VAC
Contact material		AgCdO
Operating time at Un (ms) ⁽⁴⁾		RGG.13X-17X-43X-47X
		RGG.33X-37X-63X-67X-53X-57X
	DC	DC
	Pick-up (NC contact opening)	≤ 20
	Pick-up (NO contact closing)	≤ 35
Drop-out (NO contact opening)	≤ 10	
Drop-out (NC contact closing)	≤ 53	

(1) On all contacts simultaneously, reduction of 30%.

(2) The max. peak and pulse currents are those currents that can be handled, for a specified time, by the contact. They do not refer to steady or interrupted currents.

(3) For other examples, see electrical life expectancy curves.

(4) Unless specified otherwise, the operating time signifies until stabilization of the contact (including bounces).

Insulation

Insulation resistance (at 500Vdc)	between electrically independent circuits and between these circuits and ground	> 10,000 MΩ
	between open contact parts	> 10,000 MΩ
Withstand voltage at industrial frequency	between electrically independent circuits and between these circuits and ground	2 kV (1 min) - 2.2kV (1 s)
	between open contact parts	2 kV (1 min) - 2.2kV (1 s)
	between adjacent contacts	2 kV (1 min) - 2.2kV (1 s)
Impulse withstand voltage (1.2/50μs - 0.5J)	between electrically independent circuits and between these circuits and ground	5 kV
	between open contact parts	4 kV



Mechanical specifications

	Mechanical life expectancy	10x10 ⁶ operations
Maximum switching rate	Mechanical	3600 operations/h
	Degree of protection	IP40
	Dimensions (mm)	45x50x86 ⁽¹⁾
	Weight (g)	280

(1) Excluding output terminals



Environmental specifications

Operating temperature	Standard	-25 to 55°C
	Version for railways, rolling stock	-25 to 70°C
Storage and shipping temperature		-50 to 85°C
Relative humidity		-25 to +70°C (+85°C for 10 min) -40°C as option
Fire behavior		V0



Standards and reference values

EN 61810-1, EN 61810-2, EN 61810-7	Electromechanical elementary relays
EN 60695-2-10	Fire behavior
EN 60529	Degree of protection provided by enclosures
EN 61000	Electromagnetic compatibility
EN 61810-3, Type A	Relays with forcibly guided (mechanically linked) contacts

Unless otherwise specified, the products are designed and manufactured according to the requirements of the above-mentioned European and International standards. In accordance with EN 61810-1, all items of technical data are referred to ambient temperature 23 °C, atmospheric pressure 96kPa and 50% humidity. Tolerance for coil resistance, nominal electrical input and nominal power is ±7%.



Railways, rolling stock - Standards

Applicable to RGGRX version

EN 60077	Electric equipment for rolling stock - General service conditions and general rules
EN 61373 ⁽¹⁾	Shock and vibration tests, Cat 1, Class B
EN 45545-2	Fire behavior, Cat E10, Requirement R26, V0
ASTM E162, E662	Fire behavior

(1) Permissible opening time of contacts on a de-energized relay t<3ms.



Railways, rolling stock - Special operating ranges

Nominal voltage	Minimum pick-up voltage	Maximum operating voltage	Order symbol ⁽¹⁾
24 Vdc	16.8	32	Z01
36 Vdc	23	42.5	Z01
72 Vdc	55	96	Z01
110 Vdc	77	144	Z01

(1) To order the relay with the special operating range, indicate the "Z0x" symbol in the "Keying position" field of the ordering scheme. The special range may be subject to operating specifications different from standard specifications. Please contact us for further information.



Configurations - Options

TROPICALIZATION	Surface treatment of the coil with protective coating for use with RH 95%.
GOLD PLATING	Surface treatment of the contacts, blades and output terminals with gold-cobalt alloy $\geq 2\mu$. This treatment ensures long-term capacity of the contact to conduct lower currents.
LED	LED indicator showing presence of power supply, wired in parallel with the coil.
FLYBACK DIODE	Component connected in parallel with the coil (type 1N4007) designed to suppress overvoltages generated by the coil when de-energized.
TRANSIL	Non-polarized component connected in parallel with the coil. Behaviour is similar to that of a varistor, with faster operating times.
LOW TEMPERATURE	Minimum operating temperature -50°C , only for rolling stock version (option L)



Ordering scheme

Product code	Application ⁽¹⁾	Configuration A	Configuration B	Label	Type of power supply	Nominal voltage (V) ⁽²⁾	Finish ⁽³⁾
RGG	E: Energy F: Railway, Fixed Equipment R: Railway, Rolling Stock	1: Standard 2: Gold plating + Diode // + Led 3: Diode // 4: Gold plating 5: Led 6: Gold plating + Diode // 7: Diode // + Led 8: Transil 9: Transil + Led 0: Gold plating + Transil + Led	3X: 4 CO contacts 7X: 4 CO contacts with magnetic arc blow-out	F	C: Vdc	012 - 024 - 036 048 - 072 - 110 125 - 132 - 144 220	Z0x: Special operating range (only for "R" applications) T: Tropicalized coil L: Low temperature

Example	RGG	E	3	7X	F	C	048	T	
	RGGE37XF-C048/T = ENERGY series relay with flyback diode, magnetic arc blow-out and 48Vdc tropicalized coil.								
	RGG	F	5	3X	F	C	110		
	RGGF53XF-C110 = RAILWAY series relay, fixed equipment, with LED indicator and 110Vdc coil.								

(1) ENERGY : all applications except for railway.

RAILWAYS, FIXED EQUIPMENT: application on fixed

FERROVIAIRE ET ÉQUIPEMENT FIXE : application on fixed power systems and electrical railway traction. Construction according to RFI (FS Group) specification no. RFI DPRIM STF IFS TE 143 A, if applicable. For list of RFI approved and conforming products, consult dedicated catalog "RAILWAY SERIES - RFI APPROVED"

RAILWAYS, ROLLING STOCK: application on board rolling stock (wire-rail-tramway vehicles). Electrical characteristics according to EN60077.

(2) Other values on request.

(3) Optional value: multiple selection possible (e.g. T-L)

Wiring diagram

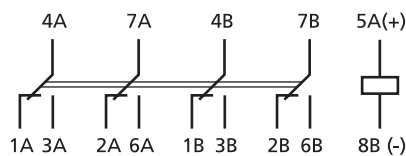

Dimensions

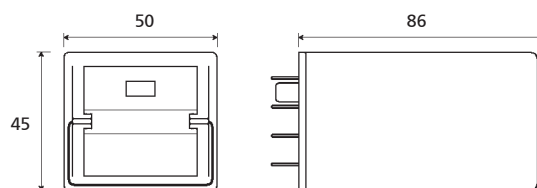

Electrical life expectancy

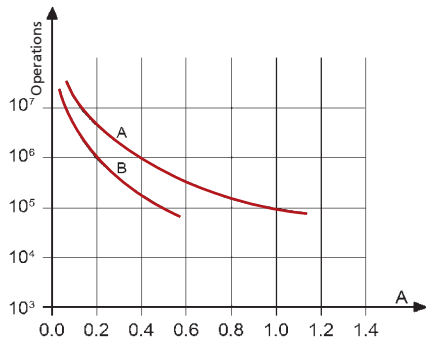

Contact loading: 110Vdc, L/R 40 ms
Curve A: RGG_x7X
Curve B: RGG_x3X

Some examples of electrical life expectancy

RGG.x3X			
U	I (A)	L/R (ms)	Operations
110 Vdc	0.5	40	100,000
110 Vdc	0.6	10	300,000
120 Vdc	0.7	40	50,000
125 Vdc	1.2	0	1,000,000
220 Vdc	0.1	40	100,000
220 Vdc	0.25	10	100,000
U	I (A)	cosφ	Operations
110 Vac	1	1	2,000,000
110 Vac	1	0.5	1,500,000
110 Vac	5	1	1,000,000
110 Vac	5	0.5	500,000
220 Vac	0.5	1	2,000,000
220 Vac	1	0.5	600,000
220 Vac	5	1	650,000
220 Vac	5	0.5	600,000

RGG.x7X			
U	I (A)	L/R (ms)	Operations
24 Vdc	1	0	7,000,000
24 Vdc	1	40	3 000,000
24 Vdc	2	40	2,000,000
24 Vdc	5	0	3,000,000
24 Vdc	5	40	200,000
24 Vdc	9	0	800,000
48 Vdc	5	20	200,000
110 Vdc	0.4	40	1,000,000
110 Vdc	1	40	200,000 ⁽¹⁾
110 Vdc	10	0	100,000
U	I (A)	cosφ	Operations
220 Vac	5	0.5	100,000
220 Vac	10	1	100,000
230 Vac	1	0.7	2,500,000
230 Vac	3	0.7	1,200,000

Switching frequency: 1,200 operations/hour
⁽¹⁾ 600 operations/hour

Sockets and retaining clips

Type of installation	Type of outputs	Model	Retaining clip
Wall or DIN rail mounting	Screw	48BIP20-I DIN	RG48
	Spring clamp	PAIR160	
Flush mounting	Screw	43IL	RG43
	Spring clamp	PRIR160	RG48
	Double faston (4.8 × 0.8 mm)	ADF2	

Mounting tips

The preferred mounting position is on the wall, with the relay positioned horizontally in the reading direction on the nameplate. For correct use of the relays, they should be spaced apart by at least 5 mm in the horizontal direction and 20 mm in the vertical direction. This is to allow correct upward dissipation of the heat generated by the coil. Set these distances according to the socket used. Distances can be reduced depending on the environmental application conditions and on the relay duty cycle. For maximum reliability in operation, it is advisable to use retaining clips. No special maintenance is required. Condensation can form inside the relay when powered up and the outside ambient temperature is cold; this is quite normal and does not affect the operation of the relay. The plastic materials of the relay do not possess hygroscopic properties.



RELAYS

INSTANTANEOUS RELAYS WITH 8 FORCIBLY GUIDED CONTACTS

RMGX SERIES with forcibly guided contacts

USER SECTORS



Power generation



Nuclear



Power transmission



Rolling Stock



Fixed railway installations



Shipbuilding



Petroleum industry



Heavy industry



RMGR16X_3

PRODUCT ADVANTAGES

- Mechanically linked contacts, relay compliant with IEC **EN 61810-3, type A**
- Weld-no-transfer technology
- Plug-in monostable instantaneous relay
- Suitable for safety applications
- Solid and rugged construction for heavy or intensive duty
- Self-cleaning knurled contacts
- Very long electrical life expectancy and exceptional endurance
- Magnetic arc blow-out (optional) for higher breaking capacity
- Wide range of options: LED indicating power on, FLYBACK DIODE
- Transparent cover, with access for manual operation (standard) and pull-out handle
- Retaining clip for secure locking of relay on socket

DESCRIPTION

RMGX relays are highly reliable products offering top performance, suitable for applications in particularly harsh and unsettled environments. Meeting the requirements of standard **EN 61810-3 type A**; the relay is equipped with mechanically linked contacts (forcibly guided), an indispensable feature for applications where there is a need to guarantee that make (NO) contacts will never assume the same status as break (NC) contacts. Forcibly guided contacts are also known as weld-no-transfer contacts. With change-over contacts, customers have the greatest possible flexibility in selecting the configuration (6 NC + 2 NO, 5 NC + 3 NO, etc.) best suited to their particular needs.

Thanks to its exceptional breaking capacity, the relay is suitable for **controlling heavy duty loads with intensive switching frequency**, where safety and continuity of operation are all-important. Manual operation as standard for all models, allowing tests to be conducted in the absence of any power supply. The contacts used are of a type designed to give top performance both with high and strongly inductive DC loads, and with particularly low loads; inclusion of the **magnetic arc blow-out function** (optional) helps to achieve a considerable increase in breaking capacity.

Knurled contacts ensure not only better **self-cleaning** characteristics, but also lower ohmic resistance thanks to multiple points of electrical connection, thereby extending the electrical life expectancy of the component.

In relays with forcibly guided (mechanically linked) or weld-no-transfer contacts, special design and constructional measures are used to ensure that make (normally-open) contacts can not assume the same state as break (normally-closed) contacts.

- If, when powering up a relay, a NC contact fails to open, the remaining NO contacts must not close, maintaining a contact gap ≥ 0.5 mm.
- When the relay is de-energized, if a NO contact fails to open, the remaining NC contact must not close, maintaining a contact gap ≥ 0.5 mm.

EN 61810-3 lays down the standard requirements for relays with forcibly guided contacts. This standard defines two types of relay with forcibly guided contacts, namely:

- Type A: Relay whose contacts are all mechanically linked (forcibly guided).
- Type B: Relay containing mechanically linked contacts and contacts which are not mechanically linked.

In the case of relays that include changeover contacts, either the make circuit or the break circuit of a changeover contact can be considered to meet the requirements of this standard.

Models	Number of contacts	Magnetic arc blow-out
RMG.x2X	6 CO + 2 NC	
RMG.x6X	6 CO + 2 NC	•

FOR CONFIGURATION OF PRODUCT CODE, SEE "ORDERING SCHEME" TABLE

Coil specifications	RMGExyX - RMGFxyX	RMGRxyX
Nominal voltages Un	DC: 24-48-110-125-132-220 ⁽¹⁾	DC: 24-36-72-96-110 ⁽²⁾
Consumption at Un (DC/AC)	3W	
Operating range	DC: 80÷115% Un	DC: 70÷125% Un
Type of duty	Continuous	
Drop-out voltage ⁽³⁾	DC: > 5% Un	

(1) Other values on request.

(2) Suitable for application on rolling stock. Operating range in compliance with EN 60077 standard.

(3) Limit value for supply voltage, expressed as % of the nominal value, beneath which the relay is certain to be de-energized.

Contact specifications	RMG.12X-16X-42X-46X	RMG.32X-36X-62X-66X-52X-56X
Number and type	6 CO + 2 NA, form C	
Current	See following graph	
Nominal	20A for 1min - 40A for 1s	
Maximum peak ⁽¹⁾	150A for 10ms	
Maximum pulse ⁽¹⁾		
Example of electrical life expectancy	RMG.x2X : 0.5A - 110Vdc - L/R 40ms - 10 ⁵ operations - 1,800operations /hour RMG.x6X : 1A - 110Vdc - L/R 40ms - 10 ⁵ operations - 1,800operations /hour	
Minimum load	Standard contacts	200mW (10V, 10mA)
	Gold-plated contacts	50mW (5V, 5mA)
Maximum breaking voltage	350 VDC / 440 VAC	
Contact material	AgCdO	
Operating time at Un (ms) ⁽²⁾	DC	
Pick-up (NC contact opening)	≤ 35	
Pick-up (NO contact closing)	≤ 60	
Drop-out (NO contact opening)	≤ 4	
Drop-out (NC contact closing)	≤ 45	

(1) Maximum peak and pulse currents are those currents that can be handled, for a specified time, by the contact. They do not refer to steady or interrupted currents.

(2) Unless specified otherwise, the operating time signifies until stabilization of the contact (including bounces).

Rated current contact

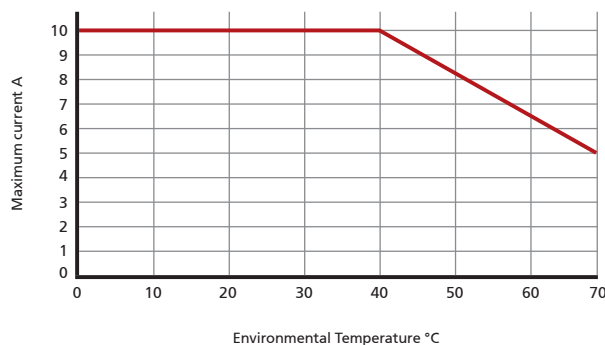

Note: reduction of 30% on all the contacts simultaneously.



Insulation

Insulation resistance (at 500 VDC) between electrically independent circuits and between these circuits and ground between open contact parts	> 10,000 MΩ > 10,000 MΩ
Withstand voltage at industrial frequency between electrically independent circuits and between these circuits and ground between open contact parts between adjacent contacts	2 kV (1 min) - 2.2 kV (1 s) 2 kV (1 min) - 2.2 kV (1 s) 2 kV (1 min) - 2.2 kV (1 s)
Impulse withstand voltage (1,2/50µs - 0,5J) between electrically independent circuits and between these circuits and ground between open contact parts	5 kV 5 kV



Mechanical specifications

Mechanical life expectancy	10x10 ⁶ operations
Maximum mechanical switching rate	3,600 operations/h
Degree of protection	IP50 fitted to socket
Dimensions (mm)	45x90x100 ⁽¹⁾
Weight (g)	380

⁽¹⁾ Excluding output terminals



Environmental specifications

Standard operating temperature	standard	-25 to +55 °C
Version for railways, rolling stock (RMGR)		-25 to +70°C (+85°C for 10 min) -40°C as option
Storage and shipping temperature		-25 to +85°C
Relative humidity		Standard: 75% RH - Tropicalized: 95% RH
Fire behavior		V0



Standards and reference values

EN 61810-1, EN 61810-2, EN 61810-7 EN 61810-3, type A EN 60695-2-10 EN 60529	All-or-nothing relays Relays with forcibly guided (mechanically linked) contacts Fire behavior Degree of protection provided by enclosures
---	---

Unless otherwise specified, products are designed and manufactured to the requirements of the European and International standards indicated above. In accordance with EN 61810-1, all items of technical data are referred to ambient temperature 23 °C, atmospheric pressure 96kPa and 50% humidity. Tolerance for coil resistance, nominal electrical input and nominal power is ±7%.



Railways, rolling stock - Standards

Applicable to RMGRX version

EN 60077 EN 61373 ⁽¹⁾ EN 45545-2 ASTM E162, E662	Electric equipment for rolling stock - General service conditions and general rules Shock and vibration tests, cat 1, class B Fire behavior, cat EL10, requirement R26, V0 Fire behavior
--	---

⁽¹⁾ Opening of NC contacts allowed only at de-energized relay t<3ms.



Configurations - Options

TROPICALIZATION	Surface treatment of coil with protective coating for use in conditions of RH 95%. This treatment serves to give the coil added protection against corrosion that could occur as a result of moisture reacting with certain chemical agents such as those found in acid or saline atmospheres.
GOLD PLATING	Surface treatment of contacts, blades and output terminals with gold, thickness ≥ 2µ. This treatment ensures long-term capacity of the contact to conduct low levels of current, even in adverse ambient conditions.
LED	long-term capacity of the contact to conduct low levels of current, even in adverse ambient conditions.
FLYBACK DIODE	Component connected in parallel with the coil designed to suppress overvoltages generated by the coil when de-energized.
LOW TEMPERATURE	Minimum operating temperature -40°C, only for rolling stock version (option "L").



Ordering scheme

Product code	Application ⁽¹⁾	Configuration A	Configuration B	Label	Type of power supply	Nominal voltage (V) ⁽²⁾	Finish ⁽³⁾	Keying position code ⁽⁴⁾
RMG	E: Energy F: Railway Fixed Equipment R: Railway Rolling stock	1: Standard 2: Dorure + Diode // + Led 3: Diode // 4: Dorure 5: Led 6: Dorure + Diode // 7: Diode // + Led	2X: 6 CO contacts + 2 NO 6X: 6 CO contacts + 2 NO with magnetic arc blow-out	F	C: Vdc	024 - 036 - 048 072 - 096 - 110 125 - 132 - 220	T: Tropicalized coil L: Low temperature	XX

Example	RMG	E	3	6X	F	C	048	T		
	RMGE36XF-C048/T = ENERGY series relay with back EMF suppression diode, magnetic arc blow-out and 48Vdc tropicalized coil.									
	RMG	R	7	2X	F	C	110			
	RMGR72XF-C110 = RAILWAY series relay, equipped with flyback diode and indicator Led and 110Vdc coil.									

- ENERGY** : all applications except for railway.
RAILWAYS, FIXED EQUIPMENT: application on fixed power systems and electrical railway traction. Construction according to RFI (FS Group, Italy) specification n° RFI DPRIM STF IFS TE 143 A, if applicable for list of RFI approved and conforming products, consult dedicated catalog "RAILWAY SERIES - RFI APPROVED"
RAILWAYS, ROLLING STOCK: Application on board rolling stock. Electrical characteristics according to EN60077.
- Other values on request.
- Optional value.
- Optional value. The positive mechanical keying is applied according to the manufacturer's model.

Wiring diagram

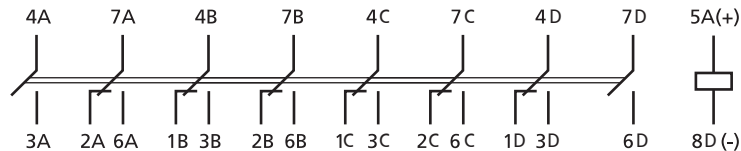

Dimensions

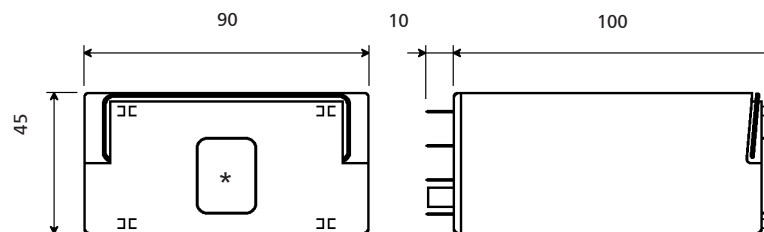

RMG.x2X - RMG.x6X

(*) access to the manual operating lever

Electrical life expectancy

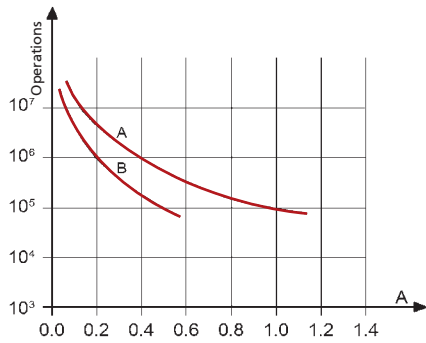

Contact loading: 110Vdc, L/R 40 ms
Curve A: RMG.x6X
Curve B: RMG.x2X

RMG.x2X			
U	I (A)	L/R (ms)	Operations
110 Vdc	0.5	40	100,000
110 Vdc	0.6	10	300,000
120 Vdc	0.7	40	50,000
125 Vdc	1.2	0	1,000,000
220 Vdc	0.1	40	100,000
220 Vdc	0.25	10	100,000
U	I (A)	cosφ	Operations
110 Vac	1	1	2,000,000
110 Vac	1	0.5	1,500,000
110 Vac	5	1	1,000,000
110 Vac	5	0.5	500,000
220 Vac	0.5	1	2,000,000
220 Vac	1	0.5	600,000
220 Vac	5	1	650,000
220 Vac	5	0.5	600,000

RMG.x6X			
U	I (A)	L/R (ms)	Operations
24 Vdc	1	0	7,000,000
24 Vdc	1	40	3,000,000
24 Vdc	2	40	2,000,000
24 Vdc	5	0	3,000,000
24 Vdc	5	40	200,000
24 Vdc	9	0	800,000
48 Vdc	5	20	200,000
110 Vdc	0.4	40	1,000,000
110 Vdc	1	40	100,000
110 Vdc	10	0	100,000
U	I (A)	cosφ	Operations
220 Vac	5	0.5	100,000
220 Vac	10	1	100,000
230 Vac	1	0.7	2,500,000
230 Vac	3	0.7	1,200,000

Switching frequency: 1,200 operations/hour

Sockets and retaining clips

Type of installation	Type of outputs	Model	Retaining clip
Wall or DIN rail mounting	Screw	96IP20-I DIN	RMC48
	Spring clamp	PAIR320	
Flush mounting	Double faston (4.8 x 0.8 mm)	ADF4-E1	
	Spring clamp	PRIR321	

Mounting tips

The preferred mounting position is on the wall, with the relay positioned horizontally in the reading direction on the nameplate. To ensure correct use of the relays, they should be spaced apart by at least 20 mm in the vertical direction; this will allow the heat generated by the coils to rise and dissipate as necessary. Check the distances according to the socket used. These distances can be reduced, depending on the environmental conditions during operation and on the relay duty cycle.

Retaining clips are used to ensure that the relay is secured correctly to the socket.

No special maintenance is required.

Condensation can form inside the relay when powered up and the outside ambient temperature is cold; this is quite normal and does not affect the operation of the relay. The plastic materials of the relay do not possess hygroscopic properties.

RELAYS

RELAYS

RELAYS

RELAYS

RELAYS

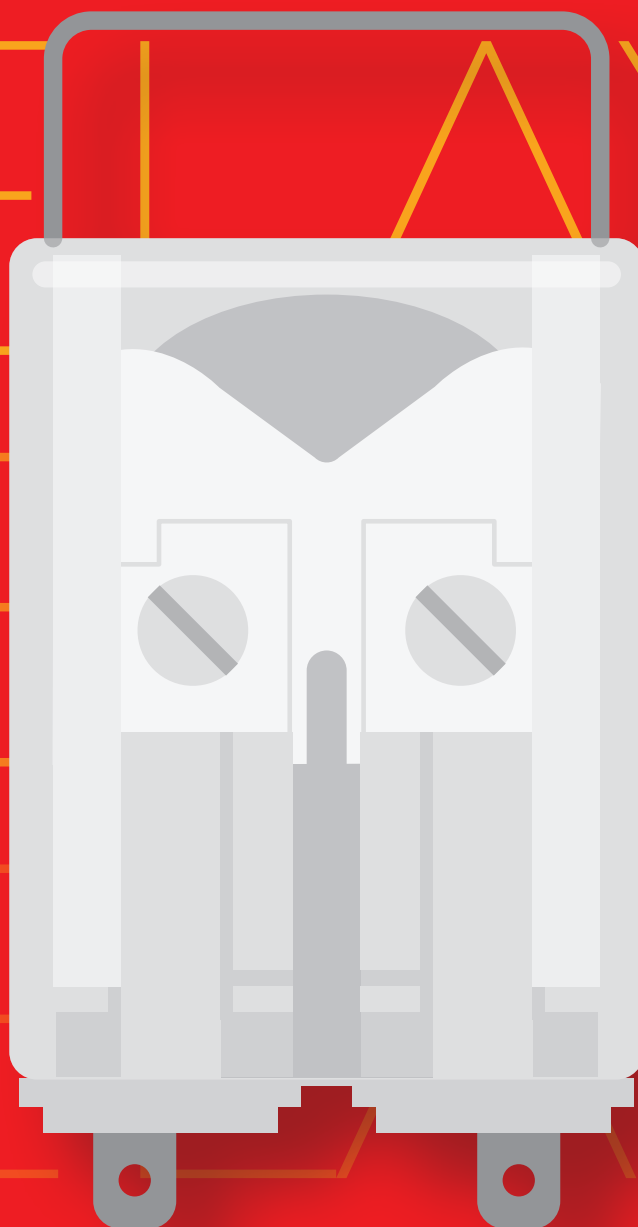

BISTABLE RELAYS



RELAYS

BISTABLE (LATCHING) RELAYS WITH 3-4 CONTACTS

RGB SERIES

USER SECTORS



Power generation



Nuclear



Power transmission



Rolling stock



Fixed railway installations



Shipbuilding



Petroleum industry



Heavy industry



RGBE13



RGBE14

PRODUCT ADVANTAGES

- Plug-in instantaneous bistable relay
- Solid and rugged construction for heavy or intensive duty
- Very long electrical life expectancy and notable endurance
- Magnetic arc blow-out for higher breaking capacity
- Fitted with mechanical optical contact status indicator as standard
- Lever for manual operation (optional)
- Self-cleaning knurled contacts
- Pulsed or permanent power supply, a.c. or d.c.
- Wide variety of configurations and customizations
- Retaining clip for secure locking of relay on socket
- Label holder in cover for customer's use
- Positive mechanical keying for relay and socket

DESCRIPTION

The bistable relays in the **RGB series** are reliable products offering **high performance**. These components have 2 stable operating states, which means that they are able to hold their current position in the event of a power supply failure, thereby guaranteeing that this can be stored as "memory" information should system faults occur during subsequent cycles. Given their superior reliability and durability, RGB relays are capable of filling roles that call for a high level of responsibility; in effect, they are used in environments where continuous duty is an essential requirement (e.g. high voltage electricity distribution stations and medium voltage substations). All models are equipped with an automatic coil de-energization system, operated mechanically or electronically, designed to reduce the power consumption of the device to zero once the operating cycle has been completed.

Thanks to its exceptional breaking capacity, the relay is suitable for controlling **heavy duty loads** with intensive switching frequency, where safety and continuity of operation are all-important. A product of proven reliability, as demonstrated by its use for over **40 years in electrical energy** transmission and distribution systems, and fixed equipment used in the railway sector.

Benefiting also from careful selection of materials, coupled with the technical and professional skills of human resources involved in design and production, this family of relays has found favour with many important and high profile customers.

The **versatility** in manufacture allows producing relays with any voltage in the range 12 to 250VDC/440VAC and with a great number of operating ranges adaptable to the various application requirements.

The contacts used are of a type designed to give notable levels of performance both with high and strongly inductive loads, and with particularly low loads. **Knurled contacts** ensure not only better **self-cleaning** characteristics, but also lower ohmic resistance thanks to multiple points of electrical connection, thereby extending the electrical life expectancy of the component.

In the case of the version with 3 contacts, there is also the facility of **manual operation**, so that tests can be performed even in the absence of electrical power. Like all our relays, models in the G series are assembled as part of a controlled manufacturing process in which every step of production is verified by the next step in succession. In effect, each relay is calibrated and tested individually, by hand, in such a way as to guarantee top reliability.

Models	Number of contacts	Power input to coils
RGBEx3	3	Common negative
RGBEx4	4	Coils galvanically separated

FOR CONFIGURATION OF PRODUCT CODE, SEE "ORDERING SCHEME" TABLE

Coil specifications	
Nominal voltages Un ⁽¹⁾	DC / AC: 12-24-48-110-125-132-144-230-380 ⁽²⁾ -440 ⁽²⁾
Consumption at Un (DC/AC) ⁽³⁾	15W / 15VA
Operating range	80...120% Un
Type of duty	Continuous

Minimum control pulse 50ms.

(1) Other values on request.

(2) Maximum value, a.c. = 380V 50Hz - 440V 60Hz.

(3) Latch and unlatch. Power consumption is zero on completion of the operating cycle, as the coil de-energizes automatically.

Contact specifications			
Number and type	3 or 4 CO, form C		
Current	Nominal ⁽¹⁾	12A	
	Maximum peak ⁽²⁾	20A for 1min - 40A for 1s	
	Maximum pulse ⁽²⁾	150A for 10ms	
Example of electrical life expectancy ⁽³⁾	0.5 A - 110 Vdc - L/R 40ms - 10 ⁵ operations - 1,200 operations/hour		
Minimum load	Standard contacts	200 mW (10 V, 10 mA)	
	Gold-plated contacts	50 mW (5 V, 5 mA)	
Maximum breaking voltage	350 VDC / 440 VAC		
Contact material	AgCdO		
TOperating time at Un (ms) ⁽⁴⁾	RGB.13-33-43	RGB.14-34-44	
	DC - AC	DC - AC	
	Pick-up (NC contact opening)	≤ 9 - ≤ 20	≤ 9 - ≤ 20
	Pick-up (NO contact closing)	≤ 30 - ≤ 35	≤ 30 - ≤ 35
	Drop-out (NO contact opening)	≤ 7 - ≤ 21	≤ 7 - ≤ 21
	Drop-out (NC contact closing)	≤ 45 - ≤ 65	≤ 45 - ≤ 55

(1) On all contacts simultaneously, reduction of 30%.

(2) Maximum peak and pulse currents are those currents that can be handled, for a specified time, by the contact. They do not refer to steady or interrupted currents.

(3) For other examples, see electrical life expectancy curves.

(4) Unless specified otherwise, the operating time signifies until stabilization of the contact (including bounces).

Insulation	
Insulation resistance (at 500Vdc)	
between electrically independent circuits and between these circuits and ground	> 10,000 MΩ
between open contact parts	> 10,000 MΩ
Withstand voltage at industrial frequency	
between electrically independent circuits and between these circuits and ground	2 kV (1 min) - 2.2 kV (1 s)
between open contact parts	2 kV (1 min) - 2.2 kV (1 s)
between adjacent contacts	2 kV (1 min) - 2.2 kV (1 s)
Impulse withstand voltage (1.2/50μs - 0.5J)	
between electrically independent circuits and between these circuits and ground	5 kV
between open contact parts	5 kV

Mechanical specifications	RGB.x3	RGB.x4
Mechanical life expectancy	20x10 ⁶ operations	
Maximum switching rate	900 operations/hour	
Degré de protection	IP40	
Dimensions (mm)	45x50x86 ⁽¹⁾	45x50x112 ⁽¹⁾
Weight (g)	270	350

(1) Excluding output terminals

Dimensions

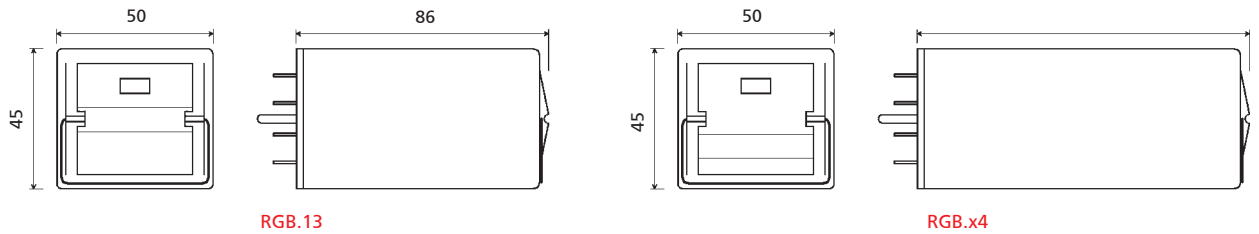

RGB.13

RGB.x4

Electrical life expectancy

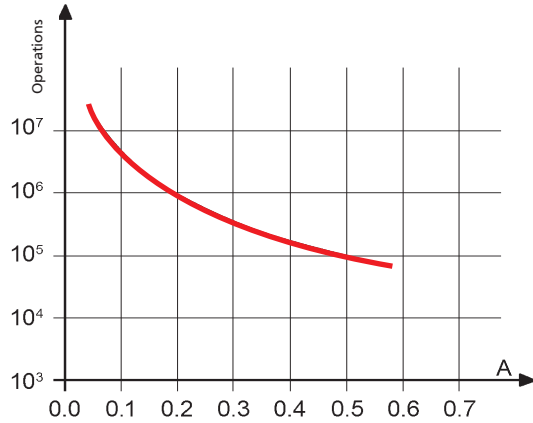

Contact loading: 110Vdc, L/R 40 ms

U	I (A)	L/R (ms)	Operations
110 Vdc	0.5	40	100,000
110 Vdc	0.6	10	300,000
120 Vdc	0.7	40	50,000
125 Vdc	1.2	0	1,000,000
220 Vdc	0.1	40	100,000
220 Vdc	0.25	10	100,000
U	I (A)	cosφ	Operations
110 Vac	1	1	2,000,000
110 Vac	1	0.5	1,500,000
110 Vac	5	1	1,000,000
110 Vac	5	0.5	500,000
220 Vac	0.5	1	2,000,000
220 Vac	1	0.5	600,000
220 Vac	5	1	650,000
220 Vac	5	0.5	600,000

Switching frequency: 1,200 operations/hour

Sockets and retaining clips

Sockets and retaining clips		Model	RGBEx3	RGBEx4-x5
Type of installation	Type of outputs		Retaining clip	
Wall or DIN rail mounting	Screw	PAVG161	VM1221	VM1222
Flush mounting	Double faston (4.8 x 0.8 mm)	PRDG161		
	Screw	PRVG161		

Mounting tips

The preferred mounting position is on the wall, with the relay positioned horizontally in the reading direction on the nameplate.
For safe and secure operation, it is advisable to use retaining clips.
No special maintenance is required.



RELAYS

BISTABLE (LATCHING) RELAYS WITH 7-8 CONTACTS

RMBX SERIES

USER SECTORS



Power generation



Nuclear



Power transmission



Rolling Stock



Fixed railway installations



Shipbuilding



Petroleum industry



Heavy industry



RMBZ12X_3

PRODUCT ADVANTAGES

- Plug-in instantaneous latching relay
- Compact dimensions than RMB Series
- Solid and rugged construction for heavy or intensive duty
- Self-cleaning knurled contacts
- Pulsed or permanent power supply and de-energization system
- Long electrical life expectancy and exceptional endurance
- Operation with DC or AC power supply
- Fitted with mechanical optical contact status indicator as standard
- Transparent cover, with access for manual operation (standard) and pull-out handle
- Retaining clip for secure locking of relay on socket
- Wide variety of configurations and customizations
- Positive mechanical keying for relay and socket

DESCRIPTION

RMBX relays are derived from models in the RMB line, offering the same specifications and performance and available with a generous number of contacts (up to 8); in short, highly reliable products providing top performance and suitable for applications in particularly harsh and unsettled environments, such as high voltage electricity distribution stations and medium voltage substations, rail transport and rolling stock applications. The mechanical design of the relay is such as to allow the development of numerous custom solutions, in the event that the standard models do not fully respond to the required performance parameters.

Thanks to its exceptional breaking capacity, the relay is suitable for controlling **heavy duty loads** where **safety** and continuity of operation are all-important.

Versatility in manufacture allows the production of relays with any voltage between 12 and 250Vd.c./230Va.c., and with a variety of operating ranges adaptable to different application requirements.

Manual operation is foreseen for all models, allowing tests to be conducted in the absence of any power supply. RMBX relays are equipped with an automatic coil de-energization system, operated mechanically, designed to reduce the power consumption of the device to zero on completion of the cycle.

The contacts used are of a type designed to give **top performance both with high and strongly inductive loads**, and with particularly low loads.

Knurled contacts ensure not only better **self-cleaning** characteristics, but also lower ohmic resistance thanks to multiple points of electrical connection, thereby extending the electrical life expectancy of the component.

Benefiting from careful selection of materials, plus the technical and professional skills of human resources involved in design and production, this is a product suitable for the most demanding of environments.

Like all our relays, these models are assembled as part of a controlled manufacturing process in which every step of production is verified by the next step in succession. **Each relay is calibrated and tested individually**, by hand, so as to guarantee top reliability.

Models	Number of contacts	Power input to coils
RMB.x3X	7	Common negative
RMB.x2X ⁽¹⁾	8	Common negative

(1) Model RMBR.x2X suitable for rolling stock applications

FOR CONFIGURATION OF PRODUCT CODE, SEE "ORDERING SCHEME" TABLE

Coil specifications	RMB.x3X, RMB.x2X	RMBR.x2X
Nominal voltages Un	DC: 12-24-48-110-125-132-220 ⁽¹⁾ - AC: 12-24-48-110-125-230-380-440 ⁽¹⁾	DC: 24 - 36 - 72 - 96 - 110 ⁽³⁾
Consumption at Un (DC/AC) ⁽²⁾	RMB.x3X: 15W / 15VA - RMB.x2: 19W / 19VA	19W / 19VA
Operating range	DC: 80÷120% Un - AC: 85÷110% Un	DC: 70÷125 % Un
Type of duty	Continuous	

Minimum control pulse: 50ms.

(1) Other values on request.

(2) Latch and unlatch. Power consumption is zero on completion of the operating cycle, as the coil de-energizes automatically.

(3) Suitable for rolling stock applications. Operating range in compliance with EN 60077 standard.

Contact specifications	RMBE.x3X	RMB.x2X
Number and type	7 CO, form C	8 CO, form C
Courant	10A	
Nominal ⁽¹⁾	20A for 1min - 40A for 1s	
Maximum peak ⁽²⁾	150A for 10ms	
Maximum pulse ⁽²⁾		
Example of electrical life expectancy ⁽³⁾	0.7 A - 132 Vdc - L/R 40ms - 10 ⁵ operations - 600 operations/hour	
Minimum load	200 mW (10 V, 10 mA)	
Standard contacts	50 mW (5 V, 5 mA)	
Gold-plated contacts		
Maximum breaking voltage	350 VDC / 440 VAC	
Contact material	AgCdO	
Operating time at Un (ms) ⁽⁴⁾	DC - AC	DC - AC
Pick-up (NC contact opening)	≤ 25 - ≤ 25	≤ 25 - ≤ 25
Pick-up (NO contact closing)	≤ 45 - ≤ 40	≤ 28 - ≤ 35
Drop-out (NO contact opening)	≤ 12 - ≤ 25	≤ 10 - ≤ 20
Drop-out (NC contact closing)	≤ 45 - ≤ 55	≤ 43 - ≤ 53

(1) On all contacts simultaneously, reduction of 30%.

(2) Maximum peak and pulse currents are those currents that can be handled, for a specified time, by the contact. They do not refer to steady or interrupted currents.

(3) For other examples, see electrical life expectancy curves.

(4) Unless specified otherwise, the operating time signifies until stabilization of the contact (including bounces).

Insulation	
Insulation resistance (at 500VCD)	
between electrically independent circuits and between these circuits and ground	> 10,000 MΩ
between open contact parts	> 10,000 MΩ
Withstand voltage at industrial frequency	
between electrically independent circuits and between these circuits and ground	2 kV (1 min) - 2.2 kV (1 s)
between open contact parts	2 kV (1 min) - 2.2 kV (1 s)
between adjacent contacts	2 kV (1 min) - 2.2 kV (1 s)
Impulse withstand voltage (1,2/50µs - 0,5J)	
between electrically independent circuits and between these circuits and ground	5 kV
between open contact parts	4 kV



Mechanical specifications

Mechanical life expectancy	10x10 ⁶ operations
Maximum mechanical switching rate	900 operations/hour
Degree of protection	IP50 fitted to socket
Dimensions (mm) ⁽¹⁾	45x90x100 ⁽¹⁾
Weight (g)	RMB.x3X: 400 RMB.x2X: 410

(1) Excluding output terminals



Environmental specifications

Standard operating temperature	standard	-25 to +55 °C
Version for railways, rolling stock (RMBR)		-25 to +70°C (+85°C for 10 min) -40°C as option
Storage and shipping temperature		-25 to +85°C
Relative humidity		Standard: 75% RH - Tropicalized: 95% RH
Fire behavior		V0



Standards and reference values

EN 61810-1, EN 61810-2, EN 61810-7	All-or-nothing relays
EN 61810-3, type A	Guided contact relays (mechanically linked), type A
EN 60695-2-10	Fire behavior
EN 60529	Degree of protection provided by enclosures

Unless otherwise specified, products are designed and manufactured to the requirements of the European and International standards indicated above. In accordance with EN 61810-1, all items of technical data are referred to ambient temperature 23 °C, atmospheric pressure 96kPa and 50% humidity. Tolerance for coil resistance, nominal electrical input and nominal power is ±7%.



Railways, rolling stock - Standards

Applicable to RMBR model

EN 60077	Electric equipment for rolling stock - General service conditions and general rules
EN 61373 ⁽¹⁾	Shock and vibration tests, cat 1, class B
EN 45545-2	Fire behavior, cat EL10, requirement R26, V0
ASTM E162, E662	Fire behavior

(1) Opening of NC contacts allowed only at de-energized relay t<3ms.



Configurations - Options

TROPICALIZATION	Surface treatment of coil with protective coating for use in conditions of RH 95%. This treatment serves to give the coil added protection against corrosion that could occur as a result of moisture reacting with certain chemical agents such as those found in acid or saline atmospheres.
GOLD PLATING	Surface treatment of contacts, blades and output terminals with gold, thickness ≥ 2μ. This treatment ensures long-term capacity of the contact to conduct low levels of current, even in adverse ambient conditions.
FLYBACK DIODE	Component connected in parallel with the coil designed to suppress overvoltages generated by the coil when de-energized.
LOW TEMPERATURE	Minimum operating temperature -40°C, only for rolling stock version (option "L")



Ordering scheme

Product code	Application ⁽¹⁾	Configuration A	Configuration B	Label	Type of power supply	Nominal voltage (V) ⁽²⁾	Finish ⁽³⁾	Keying position code ⁽⁴⁾
RMB	E: Energy F: Railway Fixed Equipment R: Railway Rolling stock	1: Standard 3: Diode // 4: Gold-plating 6: Gold-plating + Diode //	2X: 8 CO contacts 3X: 7 CO contacts	F	C : Vdc A: Vac 50 Hz H: Vac 60 Hz	012 - 024 - 036 048 - 072 - 096 110 - 125 - 132 220 - 230 - 380 440	T: Tropicalized coil L: Low temperature	XX

Example

RMB	E	4	3X	F	C	110		
RMBE43XF-C110 = ENERGY series relay, with 7 CO gold-plated contacts and 110Vdc coil								
RMB	R	1	2X	F	C	072	T	
RMBR12XF-C072T = RAILWAY, rolling stock series, relay with 8 CO contacts and 72Vdc tropicalized coil								

(1) ENERGY: all applications except for railway.

RAILWAYS, FIXED EQUIPMENT: application on fixed power systems and electrical railway traction. For list of RFI compliant and type-approved products, consult dedicated catalog "RAILWAY SERIES - RFI APPROVED".

RAILWAYS, ROLLING STOCK: application on board rolling stock. Electrical characteristics according to EN60077.

(2) Other values on request. Voltages 380V and 440V available as Vac only.

(3) Optional value.

(4) Optional value. Positive mechanical keying is applied according to the manufacturer's product model.

Wiring diagram

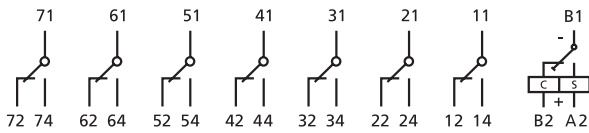

RMB.x3X

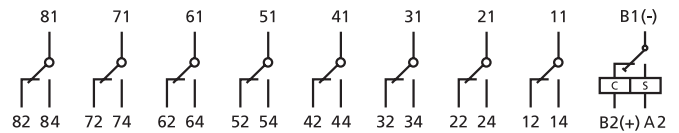

RMB.x2X

Dimensions

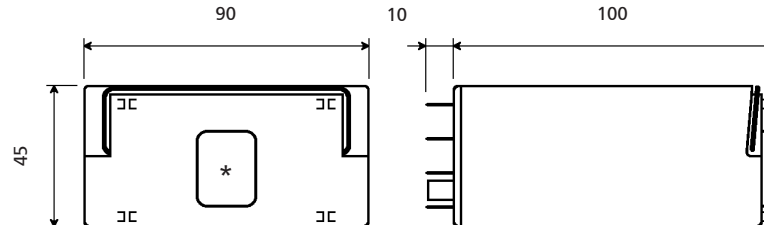

(*) access to the manual operating lever

Electrical life expectancy

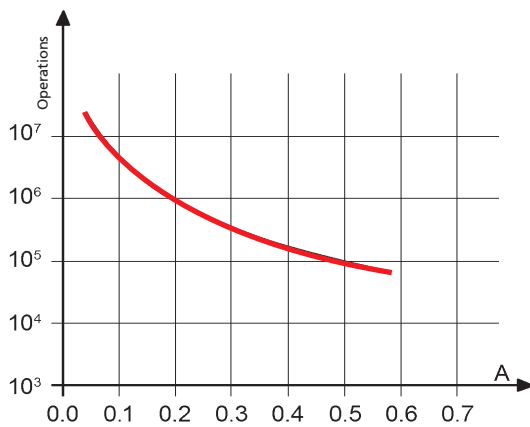

Contact loading: 110Vdc, L/R 40 ms

U	I (A)	L/R (ms)	Operations
110 Vdc	0.5	40	150,000
110 Vdc	0.6	10	300,000
132 Vdc	0.7	40	100,000
125 Vdc	1.2	0	1,000,000
220 Vdc	0.1	40	100,000
220 Vdc	0.25	10	100,000
U	I (A)	cosφ	Operations
110 Vac	1	1	2,000,000
110 Vac	1	0.5	1,500,000
110 Vac	5	1	1,000,000
110 Vac	5	0.5	500,000
220 Vac	0.5	1	2,000,000
220 Vac	1	0.5	600,000
220 Vac	5	1	650,000
220 Vac	5	0.5	600,000

Switching frequency: 1,200 operations/hour

Sockets and retaining clips

Type of installation	Type of outputs	Model	Retaining clip
Wall or DIN rail mounting	Screw	96IP20-I DIN	RMC48
	quick wiring	PAIR320	
Flush mounting	Double faston (4.8 x 0.8 mm)	ADF4	
	quick wiring	PRIR320	

(1) Suitable for mounting 2 relays side by side.

Mounting tips

The preferred mounting position is on the wall, with the relay positioned horizontally in the reading direction on the nameplate. Retaining clips are used to ensure that the relay is secured correctly to the socket.

No special maintenance is required.

Condensation can form inside the relay when powered up and the outside ambient temperature is cold; this is quite normal and does not affect the operation of the relay. The plastic materials of the relay do not possess hygroscopic properties.



RELAYS

INSTANTANEOUS BISTABLE (LATCHING) RELAYS - 7 TO 20 CONTACTS

RMB SERIES

USER SECTORS



Power generation



Nuclear



Power transmission



Rolling Stock



Fixed railway installations



Shipbuilding



Petroleum industry



Heavy industry



RMBE13

PRODUCT ADVANTAGES

- Plug-in instantaneous bistable relay
- Solid and rugged construction for heavy or intensive duty
- Very long electrical life expectancy and exceptional endurance
- Pulsed or permanent power supply, a.c. or d.c.
- Self-cleaning knurled contacts
- Fitted with mechanical optical contact status indicator as standard
- Lever for manual operation (optional)
- Wide variety of configurations and customizations
- Transparent cover, fixing/pulling screws
- Label holder in cover for customer's use
- Positive mechanical keying for relay and socket

DESCRIPTION

RMB relays are multipole bistable types sharing the same basic mechanical design as those of the RGB series, and offering the same specifications and performance. Available in versions with from **7 to 20 change-over contacts**, these highly reliable products provide top performance and are suitable for applications in **particularly harsh and unsettled environments**, such as high voltage electricity distribution stations and medium voltage substations. An automatic coil de-energization system ensures that power consumption of the relay reduces to zero once the operating cycle has been completed.

Versatility in manufacture allows the production of relays with any voltage from 12 to 250VDC/440VAC, and with a variety of operating ranges adaptable to different application requirements. The contacts used are of a type designed to give notable levels of performance both with high and strongly inductive loads, and with particularly low loads; knurled contacts ensure not only better **self-cleaning** characteristics, but also lower ohmic resistance thanks to multi-

ple points of electrical connection, thereby extending the electrical life expectancy of the component. All models offer the **facility of manual operation**, so that tests can be performed even in the absence of electrical power. To ensure that the relay remains firmly anchored to the sockets, these are equipped with fixing screws, so that there is no need for the use of retaining clips. A product of proven reliability, as demonstrated by its use for over **40 years in electrical energy transmission and distribution systems**, and fixed equipment used in the railway sector.

Like all our relays, models in the RMB series are assembled as part of a controlled manufacturing process in which every step of production is verified by the next step in succession. In effect, each relay is calibrated and tested individually, by hand, in such a way as to guarantee top reliability.

Models	Number of contacts	Power input to coils
RMB.x3	7	Common negative
RMBZ12	8	Coils galvanically separated
RMB.x5	11	Common negative
RMBZ13	12	Coils galvanically separated
RMB.x7	19	Common negative
RMBZ14	20	Coils galvanically separated



FOR CONFIGURATION OF PRODUCT CODE, SEE "ORDERING SCHEME" TABLE

Coil specification	RMB.x3	RMB.x5-x7	RMBZ12	RMBZ13-14
Nominal voltages Un ⁽¹⁾	DC / AC: 12-24-48-110-125-132-144-230-380 ⁽²⁾ -440 ⁽²⁾			
Consumption at Un (DC/AC) ⁽³⁾	15 W / 15 VA	30 W / 30 VA	19 W / 19 VA	36 W / 36 VA
Operating range	DC: 80...120% Un - AC: 85...110% Un			
Type of duty	Continuous			

Minimum control pulse: 50ms.

(1) Other values on request.

(2) Maximum value, a.c. = 380V 50Hz - 440V 60Hz.

(3) Latch and unlatch. Power consumption is zero on completion of the operating cycle, as the coil de-energizes automatically.

Contact specifications	RMB.x3	RMBZ12	RMB.x5	RMBZ13	RMB.x7	RMBZ14
Nombre et type	7 CO, form C	8 CO, form C	11 CO, form C	12 CO, form C	19 CO, form C	20 CO, form C
Current	10A					
Nominal ⁽¹⁾	10A					
Maximum peak ⁽²⁾	20A for 1min - 40A for 1s					
Maximum pulse ⁽²⁾	150A for 10ms					
Exemple de durée de vie électrique ⁽³⁾	0.5 A - 110 Vdc - L/R 40ms - 10 ⁵ operations - 1,200 operations/hour					
Minimum load	200 mW (10 V, 10 mA)					
Standard contacts	50 mW (5 V, 5 mA)					
Gold-plated contacts						
Maximum breaking voltage	350 VDC / 440 VAC					
Contact material	AgCdO					
Operating time at Un (ms) ⁽⁴⁾	RMB.x3	RMBZ12	RMB.x5	RMBZ13	RMB.x7	RMBZ14
DC - AC	DC - AC	DC - AC	DC - AC	DC - AC	DC - AC	DC - AC
Pick-up (NC contact opening)	≤ 8 - ≤ 20	≤ 9 - ≤ 20	≤ 9 - ≤ 20	≤ 10 - ≤ 20	≤ 8 - ≤ 20	≤ 8 - ≤ 20
Pick-up (NO contact closing)	≤ 30 - ≤ 35	≤ 26 - ≤ 37	≤ 32 - ≤ 37	≤ 33 - ≤ 37	≤ 25 - ≤ 35	≤ 25 - ≤ 36
Drop-out (NO contact opening)	≤ 9 - ≤ 25	≤ 8 - ≤ 25	≤ 8 - ≤ 20	≤ 9 - ≤ 22	≤ 8 - ≤ 25	≤ 9 - ≤ 27
Drop-out (NC contact closing)	≤ 56 - ≤ 65	≤ 40 - ≤ 60	≤ 50 - ≤ 60	≤ 36 - ≤ 57	≤ 43 - ≤ 53	≤ 43 - ≤ 58

(1) On all contacts simultaneously, reduction of 30%.

(2) Maximum peak and pulse currents are those currents that can be handled, for a specified time, by the contact. They do not refer to steady or interrupted currents.

(3) For other examples, see electrical life expectancy curves.

(4) Unless specified otherwise, operating times are understood as comprising stabilization of the contact (inclusive of bounces)

Insulation	
Insulation resistance (at 500Vdc)	
between electrically independent circuits and between these circuits and ground	> 10,000 MΩ
between open contact parts	> 10,000 MΩ
Withstand voltage at industrial frequency	
between electrically independent circuits and between these circuits and ground	2 kV (1 min) - 2.2 kV (1 s)
between open contact parts	2 kV (1 min) - 2.2 kV (1 s)
between adjacent contacts	2 kV (1 min) - 2.2 kV (1 s)
Impulse withstand voltage (1.2/50μs - 0.5J)	
between electrically independent circuits and between these circuits and ground	5 kV
between open contact parts	5 kV

Mechanical specifications	RMB.x3-RMBZ12	RMB.x5-RMBZ13	RMB.x7-RMBZ14
Mechanical life expectancy	20x10 ⁶ operations		
Maximum switching rate	900 operations/hour		
Degree of protection	IP40		
Dimensions (mm)	132x58x84 ⁽¹⁾	188x58x84 ⁽¹⁾	300x58x84 ⁽¹⁾
Weight (g)	450	760	1140

(1) Excluding output terminals



Environmental specifications

Operating temperature	-25 to 55°C
Storage and shipping temperature	-25 to 70°C
Relative humidity	Standard: 75% RH - Tropicalized: 95% RH
Fire behavior	V0



Standards and reference values

EN 61810-1, EN 61810-2, EN 61810-7 EN 60695-2-10 EN 61000 EN 60529	Electromechanical elementary relays Fire behavior Electromagnetic compatibility Degree of protection provided by enclosures
---	--

Sauf indication contraire, les produits sont conçus et fabriqués conformément aux prescriptions des normes européennes et internationales citées ci-dessus.
Conformément à la norme EN 61810-1, toutes les données techniques s'appliquent pour une température ambiante de 23 °C, une pression atmosphérique de 96 kPa et une humidité de 50 %.
La tolérance pour la résistance de bobine et la puissance nominale est de $\pm 7\%$.



Configurations - Options

TROPICALIZATION	Surface treatment of the coil with protective coating for use with RH 95%.
GOLD PLATING	Surface treatment of contacts, blades and output terminals with gold-cobalt, thickness $\geq 2\mu$. This treatment ensures long-term capacity of the contact to conduct lower currents.
FLYBACK DIODE	Component connected in parallel with the coil (type 1N4007) designed to suppress overvoltages generated by the coil when de-energized.
LEVER FOR MANUAL OPERATION	Allows manual operation of the relay, with the cover closed, using a screwdriver.



Ordering scheme

Product code	Application ⁽¹⁾	Configuration A	Configuration B	Label	Type of power supply	Nominal voltage (V) ⁽²⁾	Finish ⁽³⁾	Keying position code ⁽⁴⁾
RMB	E: Energy F: Railway Fixed Equipment	1: Standard 3: Diode // 4: Gold plating 6: Gold plating + Diode//	3: 7 CO contacts 5: 11 CO contacts 7: 19 CO contact	F	C: Vdc A: Vac 50 Hz H: Vac 60 Hz	012 - 024 - 048 110 - 125 - 132 144 - 220 - 230 380 - 440	T: Tropicalized coil M: Manual operation ⁽⁶⁾	xxx
		Z12 - 8 CO contacts ⁽⁵⁾ Z13 - 12 CO contacts ⁽⁵⁾ Z14 - 20 CO contacts ⁽⁵⁾						

Example	RMB	E	4	3	F	C	110	SAH
	RMBE43F-C110-SAH = ENERGY series relay, with 7 CO gold-plated contacts, 110Vdc coil and keying position SAH							
	RMB	E	1	4	F	C	110	
RMBF15F-C110 = RAILWAY series relay, fixed equipment, with 11 CO contacts, 110VDC coil								

(1) ENERGY: all applications except for railway.

RAILWAYS, FIXED EQUIPMENT: application on fixed power systems and electrical railway traction. For list of RFI approved and conforming products, consult dedicated catalog "RAILWAY SERIES - RFI APPROVED".

Also available is the STATIONS series, with ENEL approved material meeting LV15/LV16 specifications. For list of ENEL compliant and type-approved products, consult dedicated catalog "STATIONS SERIES - LV15-LV16-LV20".

(2) Other values on request. Voltages 380V and 440V available as Vac only.

(3) Optional value. Multiple selection possible (e.g. TM).

(4) Optional value. Positive mechanical keying is applied according to the manufacturer's model.

(5) Suitable for "E" and "F" applications. Gold-plated (2 μ) contacts and terminals available on request.

(6) With manual operation, no optical indicator.

Wiring diagram

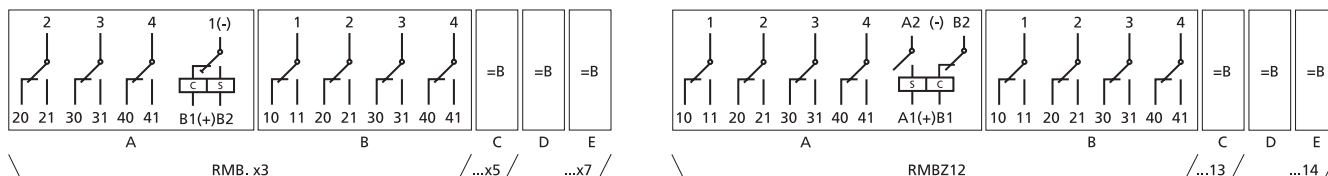

RMB.x3-5-7

RMBZ12-13-14

Dimensions

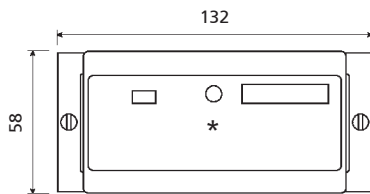

RMB.x3 - RMBZ12

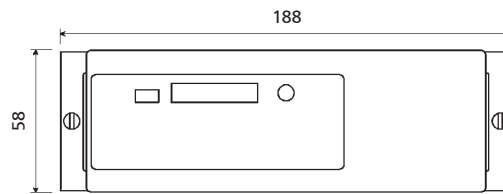

RMB.x5 - RMBZ13

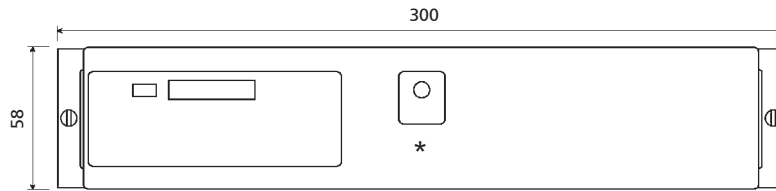
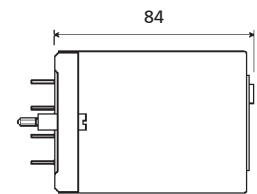

RMB.x7 - RMBZ14

(*) Models with manual operating lever (optional) are provided with a hole at the front giving access to the lever. The position of the data plate holder and the mechanical optical indicator can vary depending on the version.

Electrical life expectancy

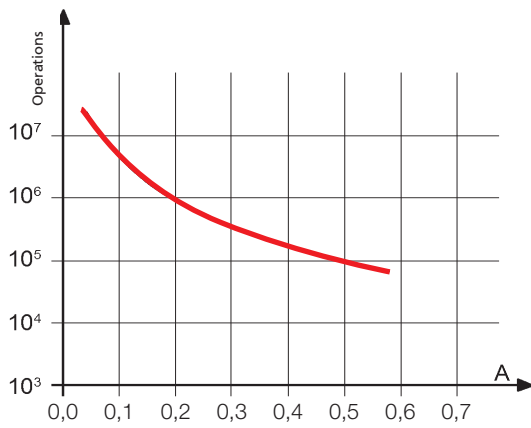

Contact loading: 110Vdc, L/R 40 ms

U	I (A)	L/R (ms)	Operations
110 Vdc	0.5	40	100,000
110 Vdc	0.6	10	300,000
120 Vdc	0.7	40	50,000
125 Vdc	1.2	0	1,000,000
220 Vdc	0.1	40	100,000
220 Vdc	0.25	10	100,000
U	I (A)	cosφ	Operations
110 Vac	1	1	2,000,000
110 Vac	1	0.5	1,500,000
110 Vac	5	1	1,000,000
110 Vac	5	0.5	500,000
220 Vac	0.5	1	2,000,000
220 Vac	1	0.5	600,000
220 Vac	5	1	650,000
220 Vac	5	0.5	600,000

Switching frequency: 1,200 operations/hour

Sockets and retaining clips

Sockets and retaining clips		RMB.x3-Z12	RMB.x5-Z13	RMB.x7-Z14	
Type of installation	Type of outputs				
Wall or DIN rail mounting	Screw	PAVM321	PAVM481	PAVM801	
	Flush mounting	Double faston (4.8 x 0.8 mm)	PRDM321	PRDM481	PRDM801
		Screw	PRVM321	PRVM481	PRVM801

Mounting tips

The preferred mounting position is on the wall, with the relay positioned horizontally in the reading direction on the nameplate. Retaining clips are not required, as a secure connection is guaranteed by the fixing screws. These same screws also serve to facilitate installation and removal of the relay. To ensure correct use, the screws must be tightened / loosened in alternating sequence, by degrees. No special maintenance is required.

Condensation can form inside the relay when powered up and the outside ambient temperature is cold; this is quite normal and does not affect the operation of the relay. The plastic materials of the relay do not possess hygroscopic properties.



RELAYS

INSTANTANEOUS BISTABLE (LATCHING) RELAYS - 4 TO 8 CONTACTS

OKBA SERIES

USER SECTORS



Power generation



Nuclear



Power transmission



Rolling Stock



Fixed railway installations



Shipbuilding



Petroleum industry



Heavy industry



OKBA

PRODUCT ADVANTAGES

- Plug-in instantaneous bistable relay
- Solid and rugged construction
- Long life expectancy
- Automatic de-energization following operation, energy saving
- Magnetic holding action
- Patent operating mechanism, designed to ensure high contact pressure
- Magnetic arc blow-out standard
- Independent and self-cleaning contacts
- Pulsed or permanent power supply, a.c. or d.c.
- Excellent shock and vibration resistance
- Wide range of sockets
- Retaining clip for secure locking of relay on socket
- Transparent cover, pull-out handle
- Positive mechanical keying for relay and socket

DESCRIPTION

OKBA bistable relays are electromechanical devices having two stable states controlled by two distinct power inputs. There are many possible applications: these relays are used mainly because they are able to maintain the status assumed after the last switching operation, even in event of a power outage occurring - in short, they have a guaranteed "memory" capability. Given their superior **reliability** and **durability**, these components are capable of filling roles that call for a high level of responsibility; in effect, they are used in environments where continuous duty is an essential requirement (e.g. electrical transformer stations and continuous cycle manufacturing processes).

OKBA relay are equipped with a mechanism (electronic or mechanical, depending on the model) that **cuts off the power supply** to the coil leads after the switching operation; this means that power consumption can be **reduced to zero, while maintaining the required operating position**. The OKBA has a common negative pole and is configured with the two negative poles separate from one another, for greater flexibility of connection.

In this model the core of a monostable relay is replaced by a special element made of magnetic material, which magnetizes when the relay is operated. In the event of a power outage, the magnet is able to hold the contacts in the operating position with a force on the **armature of 10N**. The magnet is demagnetized by a de-energize winding, which generates a magnetic field opposite to that of the energize winding, and allows the relay contacts to return to their initial position. The release winding forms part of the same coil that incorporates the latch winding. Available in versions with 4 or 8 change-over contacts.

Like all our relays, OKBA model are assembled, calibrated and tested, individually and manually, as part of a sequential manufacturing process in which each step of production is tested automatically during the course of the subsequent step.

Models	Number of contacts	Rolling stock application
OKBA	4	•
OKBA8	8	

FOR CONFIGURATION OF PRODUCT CODE, SEE "ORDERING SCHEME" TABLE

Coil specifications	
Nominal voltages Un ⁽¹⁾	DC: 24, 36, 48, 72, 110, 125, 132, 144, 220 AC: 24, 48, 110, 127, 220, 230
Max. consumption at Un ⁽²⁾ Version for rolling stock at Un ⁽²⁾	7W / VA (latch) 3.5W / VA (unlatch) ⁽³⁾ 12,5W (latch) 5,5W (unlatch)
Operating range	80...115% Un DC: 70...125% Un
Version for rolling stock	Continuous

Minimum control pulse 100 ms.

(1) Other values on request.

(2) At the moment of the relay being switched. De-energization occurs after 100 ms approx. Power consumption with relay energized: OKBA = 0.6 W / VA.

(3) For versions with 8 contacts, double the value.

Contact specifications	
Number and type	4 CO, form C ⁽¹⁾
Current	Nominal ⁽²⁾ 10A Maximum peak (1 min) ⁽³⁾ 20 A Maximum pulse (10 ms) ⁽³⁾ 150 A
Exemple de durée de vie électrique ⁽⁴⁾	0.5 A - 110 Vdc - L/R = 40 ms: 10 ⁵ operations, 900 operations / hour
Minimum load	Standard contacts 500 mW (20 V, 20 mA) Gold-plated contacts P4GEO ⁽⁵⁾ 100 mW (10 V, 5 mA)
Maximum breaking voltage	350 Vdc / 440 Vac
Contact material	AgCu
Operating time at Un (ms) ⁽⁶⁾	DC - AC Pick-up (NO contact closing) ≤ 30 Drop-out (NC contact closing) ≤ 40

(1) Version with 8 CO contacts available.

(2) On all contacts simultaneously, reduction of 30%.

(3) The max. peak and pulse currents are those currents that can be handled, for a specified time, by the contact. They do not refer to steady or interrupted currents.

(4) For other values, see electrical life expectancy curves.

(5) Specifications of gold-plated contacts on new relay

a) Plating material: P4 GEO: gold-nickel alloy (>6μ)

b) When the gold-plated contact is subject to heavy loads, it will be degraded on the surface. In such case, the characteristics of the standard contact should be taken into consideration. This does not impair relay operation.

(6) Unless specified otherwise, the operating time signifies until stabilization of the contact (including bounces).

Insulation	
Insulation resistance (at 500Vdc)	
between electrically independent circuits and between these circuits and ground	> 1,000 MΩ
between open contact parts	> 1,000 MΩ
Withstand voltage at industrial frequency	
between electrically independent circuits and between these circuits and ground	2 kV (1 min) - 2.2 kV (1 s)
between open contact parts	2 kV (1 min) - 2.2 kV (1 s)
between adjacent contacts	2 kV (1 min) - 2.2 kV (1 s)
Impulse withstand voltage (1.2/50μs - 0.5J)	
between electrically independent circuits and between these circuits and ground	5 kV
between open contact parts	5 kV

Mechanical specifications		OKBA	
Mechanical life expectancy		20x10 ⁶ operations	
Maximum switching rate	Mechanical	900 operations/hour	
Degree of protection (with relay mounted)		IP20	
		4 CO	8 CO
Dimensions (mm)		45x45x109 ⁽¹⁾	92x45x109 ⁽¹⁾
Weight (g)		~ 300	~ 620

(1) Excluding output terminals

Environmental specifications		
Operating temperature	Standard	-10 to +55°C
	Version for railways, rolling stock	-25 to +70°C
Storage and shipping temperature		-25 to +70°C
Relative humidity		Standard: 75% RH - Tropicalized: 95% RH
Resistance to vibrations		1g - 10 to 50 Hz
Resistance to shock		3g
Fire behavior		to EN 60695-2-10

Standards and reference values	
EN 61810-1, EN 61810-2, IEC 61810-7	Electromechanical elementary relays
EN 60695-2-10	Fire behavior
EN 50082-2	Electromagnetic compatibility
EN 60529	Degree of protection provided by enclosures

Unless otherwise specified, the products are designed and manufactured according to the requirements of the above-mentioned European and International standards. In accordance with EN 61810-1, all items of technical data are referred to ambient temperature 23 °C, atmospheric pressure 96kPa and 50% humidity. Tolerance for coil resistance, nominal electrical input and nominal power is ±7%.

Railways, rolling stock - Standards	
EN 60077	Electric equipment for rolling stock - General service conditions and general rules
EN 50155	Electronic equipment used on rolling stock
EN 61373	Shock and vibration tests, Cat 1, Class B
EN 45545-2	Fire behavior, Cat E10, Requirement R26, V0
ASTM E162, E662	Fire behavior

Configurations - Options	
P2	Tropicalization of the coil with epoxy resin for use with 95% RH (@ T 50 °C). This treatment also protects the coil against corrosion which could occur by combination of the humidity with certain chemical agents, such as those found in acid atmospheres (typical of geothermal power stations) or saline atmospheres.
P4GEO	Gold plating of contacts with gold-nickel alloy, thickness ≥ 6μ. This treatment ensures long-term capacity of the contact to conduct lower currents in harsh ambient conditions such as acid atmospheres (typical of geothermal power stations) or saline atmospheres.
P5GEO	P4GEO gold-plating of contacts + P2 coil tropicalization.
P6GEO	P4GEO type gold-plating, but applied to contacts, contact terminals and output terminals + P2 coil tropicalization.
FLYBACK DIODE	Polarized component connected in parallel with the coil (type 1N4007 or BYW56 for rolling stock version) designed to suppress overvoltages generated by the coil when de-energized.
IP40	IP40 protection with "6" handle or closure with screws.
8 contacts	Version with 8 change-over contacts, obtained using 2 x 4 CO relays, coils connected in series.
LOW TEMPERATURE (OKBA, 4 CO only)	Minimum operating temperature -40 °C, only for Rolling stock version (option "L").



OKBA Ordering scheme

Product code	Number of contacts	Application ⁽¹⁾	Configuration A	Configuration B	Label	Type of power supply	Nominal voltage (V) ⁽²⁾	Keying position ⁽³⁾
OKBA	4: 4 CO ⁽⁴⁾ 8: 8 CO	E: Energy / Railway Fixed Equipment R: Railway Rolling Stock	1: Standard 2: Diode //	0 : Standard 2 : P2 4 : P4 GEO 5 : P5 GEO 6 : P6 GEO	F	C: Vdc A: Vac 50 Hz	024 - 036 - 048 072 - 096 - 110 125 - 127 - 132 144 - 220 - 230	XXX L: Low temperature

Example

OKBA		E	1	0	F	C	144	
OKBAE10F-C144 - OKBA relay, ENERGY series, nominal voltage 144 Vdc								
OKBA	8	E	1	2	F	C	024	
OKBA8E12F-C024 - OKBA relay, ENERGY series, nominal voltage 24 Vdc, equipped with 8 contacts and P2 finish (tropicalization of coil)								

(1) E = ENERGY: all applications, except for railways rolling stock.

Suitable on energy production, transport and distribution plants, railways fixed equipment, petrolchemical and heavy industry.

R = RAILWAYS, ROLLING STOCK: Application on board rolling stock (rail-tram-trolley vehicles). Electrical characteristics according to EN60077.

Available also the product series:

RAILWAYS, FIXED EQUIPMENT: Approved and conforming relays and products to RFI (FS Group) specification no. RFI DPRIM STF IFS TE 143 A

For the list of RFI approved and conforming products, consult dedicated catalog "RAILWAY SERIES – RFI APPROVED".

STATIONS: ENEL approved material meeting LV15/LV16 specifications.

For the list of ENEL approved and conforming products, consult the dedicated catalog "STATIONS SERIES – LV15-LV16-LV20".

(2) Other values on request.

(3) Optional value. The positive mechanical keying is applied according to the manufacturer's model.

(4) For the standard version with 4 contacts, the field must be left empty.

Wiring diagram

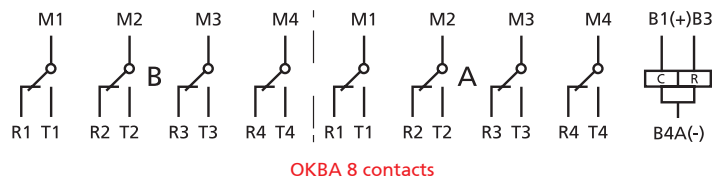
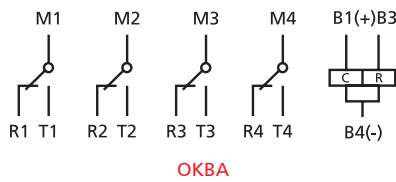

Dimensions

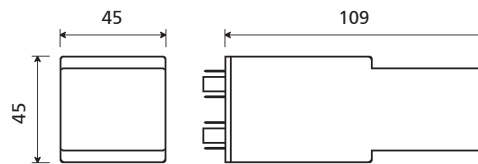

OKBA

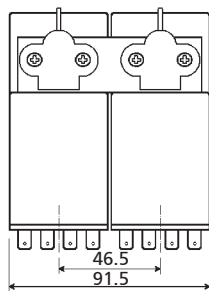

OKBA 8 contacts

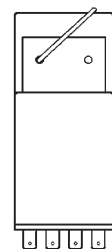

6B handle IP20 (standard)

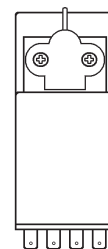

6 handle IP40

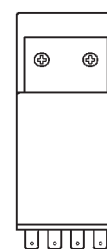

Closure with screws IP40

Electrical life expectancy

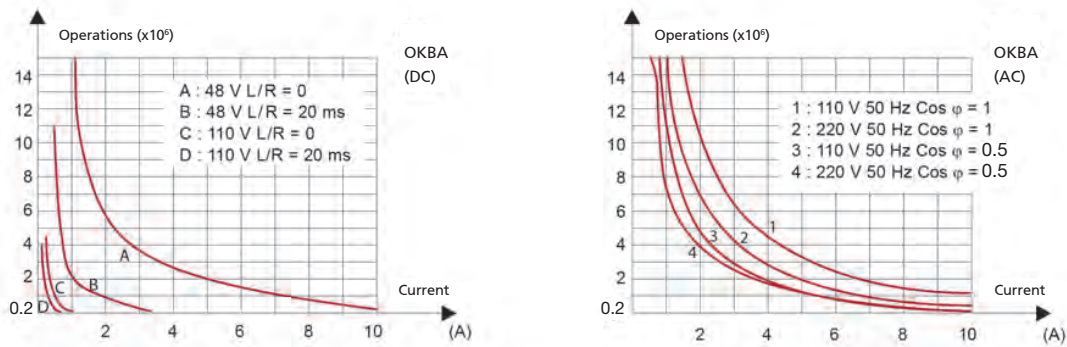

OKBA: other examples of electrical life expectancy available on the technical data sheet of the OK series relay (OKSFC model)

Sockets and retaining clips	OKBA, 4 CO ⁽¹⁾	
Number of terminals (standard dimensions 5x0.8mm)	16	Retaining clip ⁽²⁾
For wall or rail mounting		
Spring clamp, wall or DIN H35 rail mounting	PAIR160	RL48
Screw, wall or DIN H35 rail mounting	48BIP20-I DIN	RL48
Screw, wall mounting	48BL	RL48
Double faston, wall mounting	48L	RL48
For flush mounting		
Double faston (4.8 x 0.8 mm)	ADF2	RL48
Screw	43IL ⁽³⁾	RL43
For mounting on PCB		
	65	RL43

(1) For version with 8 contacts, assume 2 sockets respectively for each relay. In this instance, the mounting distance between centers of the sockets must be 45 mm. The ADF socket cannot be used.

(2) Assume 2 clips for relays with 8 contacts.

(3) Insert the clip before fastening the socket to the panel.
For more details, see specifications of mounting accessories.

Mounting tips

The preferred mounting position is on the wall, with the relay positioned horizontally in the reading direction on the nameplate. These bistable relays are equipped with automatic de-energization. When mounting, accordingly, there is no need for them to be spaced apart as they do not draw power continuously and therefore will not overheat. For safe and secure operation, it is advisable to use retaining clips. No special maintenance is required. Condensation can form inside the relay when powered up and the outside ambient temperature is cold; this is quite normal and does not affect the operation of the relay. The plastic materials of the relay do not possess hygroscopic properties.

RELAYS

RELAYS

RELAYS

RELAYS

RELAYS

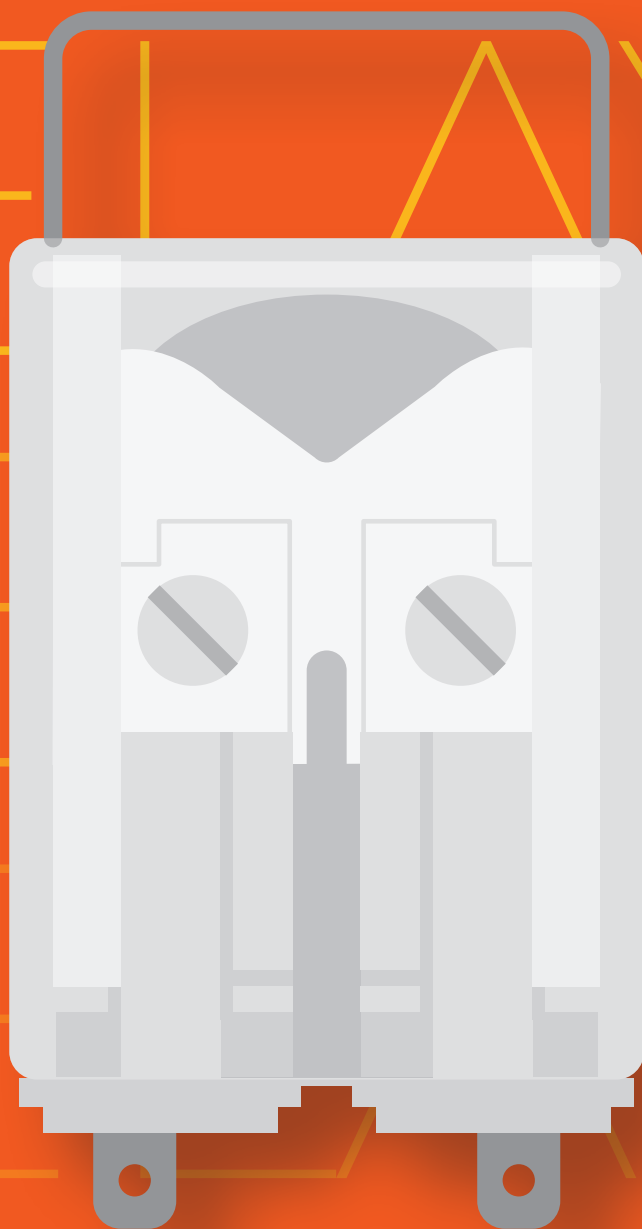

FAST-ACTING (MONOSTABLE AND BISTABLE)



RELAYS

FAST-ACTING MONOSTABLE (TRIP) RELAYS - 4-8-12 CONTACTS

RGMVX | RMMVX SERIES

USER SECTORS



Power generation



Nuclear



Power transmission



Rolling stock



Fixed railway installations



Shipbuilding



Petroleum industry



Heavy industry



RGMV16X



RMMV12X

PRODUCT ADVANTAGES

- High speed operation, tripping applications
- High Burden configuration, providing immunity to capacitance discharges
- Plug-in relays
- High performance, compact dimensions, light weight
- Solid and rugged construction for intensive duty
- Self-cleaning knurled contacts, C/O type
- Wide contact gap for a very high breaking capacity, electrical life expectancy and insulation.
- Magnetic arc blow-out as standard
- Wide range of sockets
- Retaining clip for secure relay locking on socket
- Transparent cover, LED as standard and pull-out handle

DESCRIPTION

RGMV and RMMV relays are highly reliable, high performance products, suitable for applications in very harsh and disturbed environments, such as protection, command and control systems in HV electrical substations or power stations.

The range includes relays with 4, 8 and 12 contacts.

These relays are specially designed for tripping circuit breaker applications, where a fast-acting contact is essential, in order to minimize the total operating time and to avoid destruction of very expensive equipment in emergency situations.

The high speed operation, the valuable breaking capacity and the ability to switch very low loads (few mA) as well allow their use in demanding applications, where a minimum switching time is required.

- Multiplication of HV/MV protective outputs.
- Direct actuation on HV/MV primary equipment.
- Transmission of trip alarms.

High insulation levels help to limit the propagation of induced voltages, keeping different parts of the system separated for functional safety purposes, thus avoiding unwanted intrusive phenomena.

The contacts are designed to provide remarkable performance both for high, inductive loads and very low loads. Each contact is able to switch from 10mA – 10V even without gold-plating.

The knurled surface ensures excellent self-cleaning and a lower ohmic resistance thanks to the various points of electrical contact, while also improving the electrical life expectancy of the component.

Magnetic arc blow-out helps to increase the breaking capacity: the relay is suitable for controlling heavy duty loads with intensive switching frequencies.

The “High burden” (HB) configuration provides immunity against capacitance (currents and power) discharge to the coil, in order to avoid relay operations in the event of transients due to extensive wiring, for example.

The construction of the relays and a careful choice of the materials ensure long life expectancy and considerable ruggedness even in harsh operating environments and in the presence of strong temperature fluctuations. IP40 protection is guaranteed.

Models	Number of contacts	HIGH BURDEN ⁽¹⁾ configuration	Manual operation	Operating time Pick-up (ms)
RGMV16X	4	-	-	≤ 8 ms
RGMV17X	4	✓		
RMMV12X	8	-	✓	≤ 8 ms
RMMV16X	8	✓		
RMMV11	12	-	Option	≤ 10 ms
RMMV17	12	✓		

(1) HIGH BURDEN Configuration: for the operating and the specifications refer to the paragraph "COIL DATA - HIGH BURDEN Configuration" (see the table below).

FOR PRODUCT CODE CONFIGURATION, SEE THE "ORDERING SCHEME" TABLE

COIL DATA - STANDARD Configuration	4 CO, 8 CO	12 CO
Nominal voltages at Un	DC: 24-48-110-125-220V AC: 230V	
Consumption at Un	≤ 3,5 W	≤ 6 W
Current AVG peak at pick-up ⁽¹⁾	24Vdc < 0.8A / 20ms 48 - 110 - 125Vdc: < 0.3A / 20ms 220Vdc: < 0.1A / 20ms	24Vdc: < 1.2A / 20ms 48 - 110 - 125Vdc: < 0.5A / 20ms 220Vdc: < 0.1A / 20ms
Operating range	DC: 80 ÷ 110% Un / AC: 80 ÷ 110%	
Type of duty	Continuous	
Drop-out voltage	DC: > 5% Un	

(1) ±15 %.

Coil data HIGH BURDEN configuration	4 CO, 8 CO	12 CO
Nominal voltages at Un	DC: 24-48-110-125-220V	
Consumption at Un	≤ 3,5 W	≤ 6 W
Consumption at pick-up	24 - 48Vdc: < 150W (< 2ms) 110 - 125 - 220Vdc: < 300W (< 2ms)	
Immunity to capacitive discharge	10 µF @ 120% Un across the coil	
Operating range	80 ÷ 110% Un	
Type of duty	Continuous	
Drop-out voltage	DC: > 5% Un	

The **CONFIGURATION HIGH BURDEN** provides higher security in plant control system, avoiding unwanted relay operation due to capacitive discharge currents, for example in case of an earth fault in long DC cables.

A typical application is where the initiating contact may be remote from tripping relay. **HIGH BURDEN** Tripping Relays is designed to withstand a "10µF capacitor discharge test".

- Relay will not operate when a 10 µF capacitor, charged @ 120% Un, is applied across the coil.

While switching, high energy is required. After operation, high coil burden is reduced to a very low value, ensuring energy saving and avoiding overload on power supply circuit or station battery.

An electronic circuit acts as coil voltage' regulator and controls the duration of burden.

Contact data		4 CO	8 CO	12 CO
Current	Nominal ⁽¹⁾	10A		
	Maximum pulse ⁽²⁾	20A for 1min 40A for 1s 150A for 10ms		
Example of electrical life ⁽³⁾		1A - 110Vdc - L/R 0ms - 350,000 operations 0.5A - 220Vdc - L/R 0ms - 300,000 operations		
Making capacity		30A (for 200ms) - 110Vdc - L/R 0ms: 2,000 operations		
Minimum load ⁽⁴⁾	Standard contacts	200mW (10V, 10mA)		
	Gold-plated contact ⁽⁵⁾	50mW (5V, 5mA)		
Maximum breaking voltage		250Vdc / 350Vac		
Contact material		AgCdO		
Operating time at Un (ms) ⁽⁶⁾	Pick-up ms	Vdc: ≤ 8	Vdc: ≤ 10	Vdc: ≤ 10
	Drop-out ms	Vdc: ≤ 40	Vdc: ≤ 50	Vdc: ≤ 50

(1) On all contacts simultaneously, reduction of 30%.

(2) The maximum pulse currents are those currents that can be handled, for a specified time, by the contact. They do not refer to make or break currents.

(3) For other examples, see electrical life expectancy curves.

(4) Values referred to a new product, measured in laboratory.

The ability to maintain this performance over the time depends on the environmental conditions and the contact' frequency use.

The use of gold plated contacts is recommended in the case of very low loads.

(5) A gold contact, if subjected to high loads, degrades superficially. In this case, the characteristics of the standard contact must be considered. This does not affect the operation of the relay.

(6) Unless specified otherwise, the operating times are expressed excluding bounces.

Only for Vac power supply: actual value may increase of max 5ms (pick-up, worst case) or 10ms (drop-out, worst case). It depends on the sinusoid front (rising or falling) while energizing or de-energizing.

Insulation		
Insulation resistance (at 500Vdc) between electrically independent circuits and between these circuits and ground		> 1,000 MΩ
Dielectric withstanding voltage at industrial frequency between electrically independent circuits and ground between adjacent contacts		2 kV (1 min) - 2.2 kV (1 s) 2 kV (1 min) - 2.2 kV (1 s)
Impulse withstand voltage (1.2/50µs - 0.5J) between electrically independent circuits and between these circuits and ground between open contact parts		5 kV 3 kV

Mechanical specifications		4 CO	8CO	12 CO
Mechanical life expectancy		10x10 ⁶ operations		
Maximum switching rate	Mechanical	3,600 operations / h		
Degree of protection (with relay mounted)		IP40		
Dimensions (mm) ⁽¹⁾	Mod. RGMV16X 45x50x86	45x90x100	58x188x84	
	Mod. RGMV17X 45x50x112			
Weight (g)		270	400	810

(1) Output terminals excluded.

Environmental characteristics		
Operating temperature		-25 ÷ +55°C
Storage and shipping temperature		-40 ÷ +85°C
Relative humidity		Standard: 75% UR - Tropicalized: 95% UR
Fire behaviour		V0

Standards and reference values		
EN 61810-1, EN 61810-2, EN 61810-7 EN 60695-2-10 EN 60529 EN 61000		Electromechanical elementary relays Fire behaviour Degree of protection provided by enclosures Electromagnetic compatibility



Configurations - Options

TROPICALIZATION	Surface treatment of the coil with protective coating for use with RH 95%.
GOLD PLATING	Surface treatment of the contacts, blades and output terminals with gold-cobalt alloy $\geq 2\mu$. This treatment ensures long-term ability of the contact to conduct lower currents.
LEVER FOR MANUAL OPERATION	Allow to manual operating the relay (available only for the RMMV11 and RMMV17 models)
HIGH BURDEN (HB)	The HB "High Burden" Configuration provide immunity to capacitance discharge currents & power to the coil, in order to avoid relay operations, for example in case of transients coming from extensive wiring.



Ordering scheme

Product code	Configuration A	Configuration B	Label	Type of power supply	Nominal voltage (V)	Finish ⁽¹⁾
RGMVX	1: Standard 4: Gold Plating	6X: 4 contacts 7X: 4 contacts with HB	F	C: Vdc A: Vac	Vdc 024 - 048 - 110 - 125 Vac 230 ⁽²⁾	T: Tropicalized coil (lever for manual operation not available)
RMMVX	1: Standard 4: Gold Plating	2X: 8 contacts 6X: 8 contacts with HB		C: Vdc A: Vac	Vdc 024 - 048 - 110 - 125 Vac 230 ⁽²⁾	T: Tropicalized coil (lever for manual operation always included)
RMMVX	1: Standard 4: Gold Plating	1: 12 contacts 7: 12 contacts with HB		C: Vdc A: Vac	Vdc 024 - 048 - 110 - 125 Vac 230 ⁽²⁾	T: Tropicalized coil M: Lever for manual operation

(1) Optional value. Possible the multiple choice (Ex. TM)

(2) NOT AVAILABLE FOR HB Configuration

Example	RGMV	1	7X	C	024	
	RGMV17X-C024= Relay with standard contacts, 4 C/O, High Burden configuration, 24Vdc coil					
	RMMV	4	1	A	230	M
	RMMV41-A230/M= Relay with gold plating, 12 C/O, 230Vac coil, lever for manual operation					

Wiring diagram

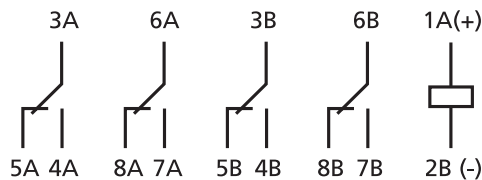

RGMV16X - RGMV17X

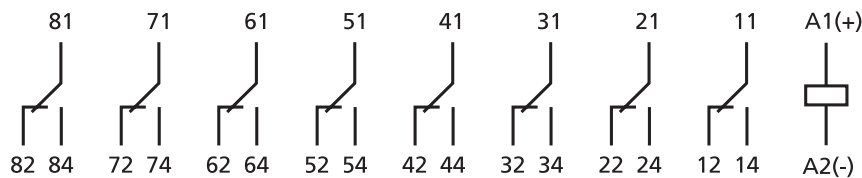

RMMV12X - RMMV16X

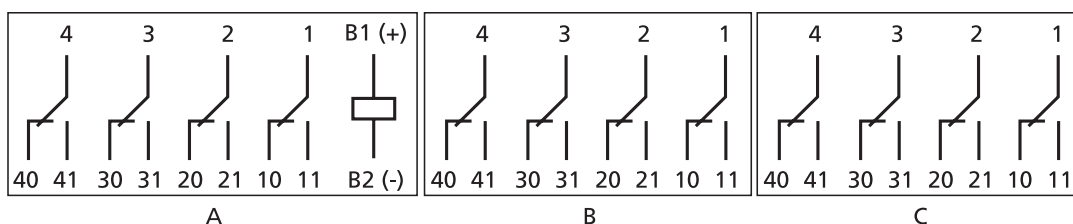

RMMV11 - RMMV17

Dimensions

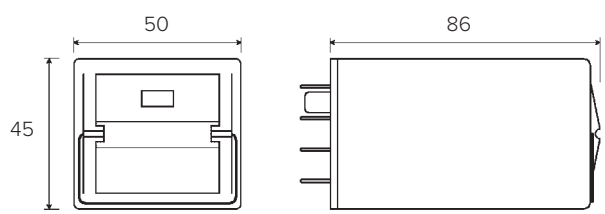

RGMV16X - RGMV17X

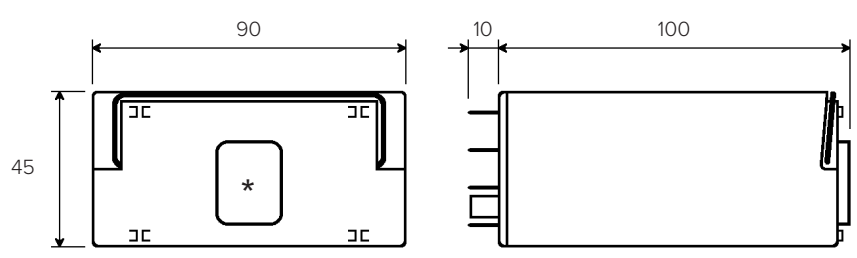

RMMV12X - RMMV16X

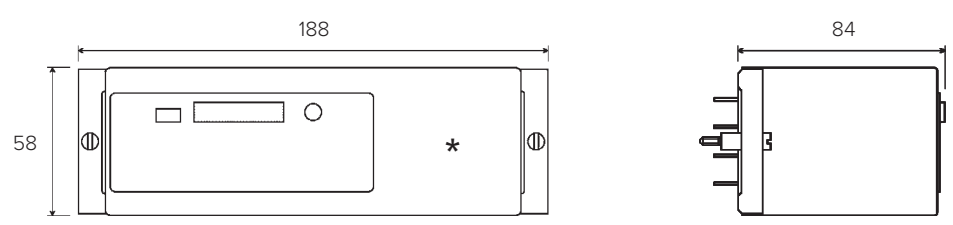

RMMV11 - RMMV17

Electrical life expectancy

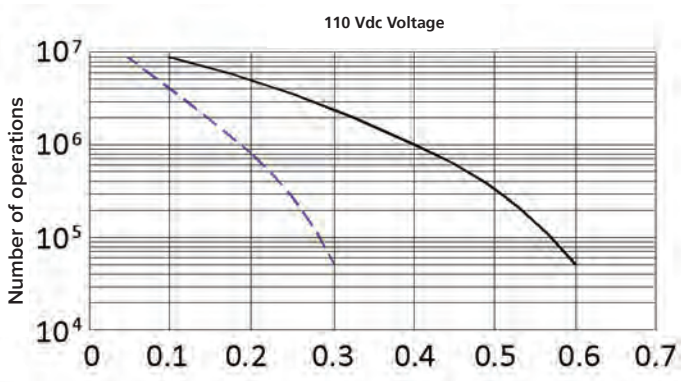
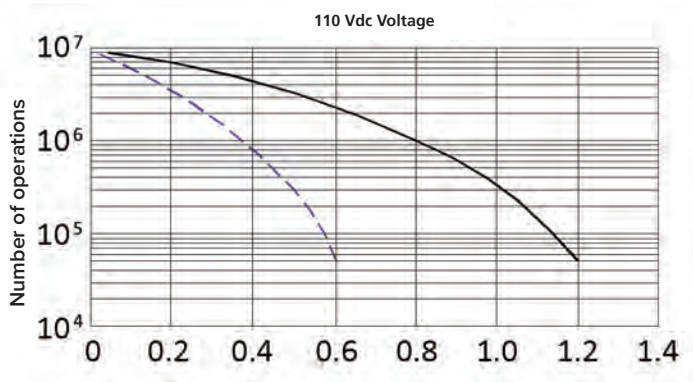
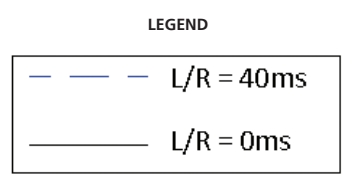
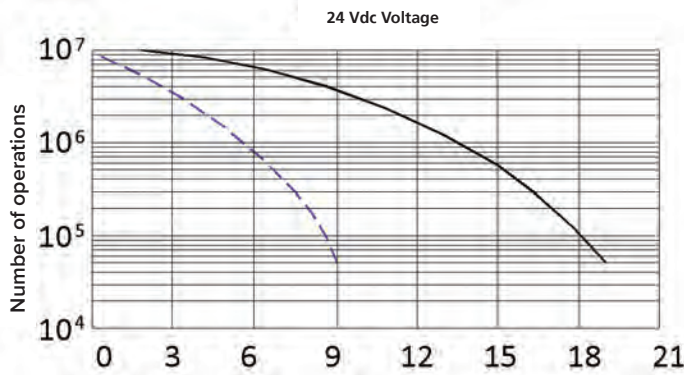

Sockets		RGMV.x6X - RGMV.x7X	RMMVx2X - RMMVx6X	RMMVx1 - RMMVx7
Type of installation	Type of outputs	Model		
Wall or DIN H35 rail mounting	Screw	48BIP20-I DIN	96IP20-I DIN	PAVM481
	Spring clamp	PAIR160	PAIR320	-
Flush mounting	Screw	-	-	PRVM481
	Spring clamp	PRIR160	PRIR320	-
	Double faston (4.8 x 0.8 mm)	ADF2	ADF4	PRDM481

Retaining clip	RGMV.x6X - RGMV.x7X	RMMVx2X - RMMVx6X	RMMVx1 - RMMVx7
Sockets models	Modèle		
48BIP20-I DIN, 96IP20-I DIN	RG48	RMC48 ⁽¹⁾	-
PAIR160, PAIR320			-
ADF2, ADF4			-
PAVM481, PRVM481, PRDM481	-	-	Fixing with integrated screws

(1) 2 pieces for each relay

MONOSTABLE INSTANTANEOUS
INSTANTANEOUS MONOSTABLE WITH FORCIBLY GUIDED CONTACTS
BISTABLE
FAST-ACTING (MONOSTABLE AND BISTABLE)
TIME DELAY (ON PICK-UP OR DROP-OUT)
TIME DELAY WITH FORCIBLY GUIDED CONTACTS
MEASUREMENT
SOCKET NUMBERING EXPLANATIONS
FRONT CONNECTION
BACK CONNECTION
PCB MOUNT
RETAINING CLIPS
KEYING



RELAYS

FAST-ACTING MONOSTABLE RELAYS WITH 2-4-8 CONTACTS

RGR | RGMV | RMMZ | RMMV SERIES fast-acting

USER SECTORS



Power generation



Nuclear



Power transmission



Rolling stock



Fixed railway installations



Shipbuilding



Shipbuilding



Heavy industry

PRODUCT ADVANTAGES

- Fast-acting monostable relay
- Solid and rugged construction for heavy or intensive duty
- Very long electrical life expectancy and exceptional endurance
- Self-cleaning knurled contacts
- Direct current operation
- Retaining clip or fixing screws for secure locking of relay to socket
- Transparent cover, pull-out handle or fixing/pulling screws
- Label holder in cover for customer's use
- Positive mechanical keying for relay and socket



RGMV13



RMMV12

DESCRIPTION

Fast-acting **monostable relays** are available in 6 models with different types and numbers of contacts. This family of relays is able to guarantee high speed switching of contacts during pick-up or during drop-out, depending on the model. All models are based on the electromechanical design of the G series, except for the RGRE, which utilizes reed contact technology. These relays can be operated off a d.c. power supply.

In an instantaneous monostable relay, the closure of an NO contact takes normally between 15 and 40 ms, depending on the particular product specifications. By contrast, a fast-acting relay is able to close the contact in a **time of between 2.5 and 10 ms**.

The operating time is measured from the moment when the coil is energized/de-energized until completion of the change in status and stabilization of the contact, including bounces. A 'bounce' is an intermediate position assumed by the contact during the course of stabilization in its final position. Unless specified otherwise, the operating times indicated for our relays include the duration of the bounce. It is advisable to discuss this aspect thoroughly, with the manufacturer, when selecting the component. Knurled contacts ensure not only better self-cleaning characteristics, but also lower ohmic resistance thanks to multiple points of electrical connection, thereby extending the electrical life expectancy of the component.

Typical sectors of use are among the most demanding, such as, for example, electricity generating stations, electrical transformer stations, fixed equipment for railways, or industries using continuous production processes (chemical and petrochemical, rolling mills, cement factories, etc.). The **performance and reliability** of the product have secured its **approval with ENEL** and other multi-utilities.

Fast-acting relays are often incorporated into circuits of special importance, such as those providing protection and breaker functions on a power line in the event of faults occurring. With this in mind, the operating speed is an essential parameter for electrical system designers. The contacts are connected to multifunction digital protection devices or recording instruments (disturbance recorders).

Like all our relays, the models in the fast-acting monostable series are assembled as part of a controlled manufacturing process in which every step of production is verified by the next step in succession. In effect, each relay is **calibrated and tested individually**, by hand, in such a way as to guarantee top reliability.

Models	Type	Number of contacts	Nominal current	Operating time ⁽¹⁾	
				Pick-up	Drop_out
RGRE12	Monostable	2 CO (reed)	2 A	≤ 2,5 ms	≤ 3 ms
RGMV12	Monostable	4 CO	10 A	≤ 8 ms	≤ 45 ms
RGMV13	Monostable	4 NC	10 A	-	≤ 8 ms
RMMV12	Monostable	8 NO	10 A	≤ 6 ms	-
RMMV13	Monostable	4 NO + 4 NC	10 A	≤ 6 ms (NO)	≤ 6 ms (NC)
RMMZ11	Monostable	8 CO	10 A	≤ 8 + 5 ms	≤ 50 ms

(1) Unless specified otherwise, the operating time signifies until stabilization of the contact (including bounces).

FOR CONFIGURATION OF PRODUCT CODE, SEE "ORDERING SCHEME" TABLE

Coil specifications	RGRE12	RGMV12	RGMV13	RMMV12	RMMV13	RMMZ11
Nominal voltages Un	DC: 24-48-110-125-220 ⁽¹⁾					
Consumption at Un	1 W	4 W		7 W		
Operating range	DC: 80...120% Un	DC: 80...110% Un				
Type of duty	Continuous					
Drop-out voltage ⁽²⁾	DC: > 5% Un					

(1) Other values on request.

(2) Limit value for supply voltage, expressed as % of the nominal value, beneath which the relay is certain to be de-energized.

Contact specifications	RGRE12	RGMV12	RGMV13	RMMV12	RMMV13	RMMZ11
Number and type	2 CO, form C REED	4 CO, form C	4 CO, form C	8 NO	4 NO + 4 NC	8 CO, form C
Current						
Nominal ⁽¹⁾	2A	10A				
Maximum peak ⁽²⁾	-	20A for 1min - 40A for 1s				
Maximum pulse ⁽²⁾	-	150A for 10ms				
Example of electrical life expectancy ⁽³⁾	0.1A - 110Vdc - L/R=40ms - 10 ⁵ operations 1,800 operations/hour	0.3 A - 110 Vdc - L/R = 40 ms - 10 ⁵ operations - 1,800 operations/hour				
Minimum load	200 mW (10 V, 10 mA)	200 mW (10 V, 10 mA)				
Maximum breaking voltage	300 V	350 VDC / 440 VAC				
Contact material	Rh	AgCdO				
Operating time at Un (ms) ⁽⁴⁾						
Pick-up (NO contact closing)	≤ 2.5	≤ 8	-	≤ 6	≤ 6	≤ 8 + 5 ⁽⁵⁾
Drop-out (NC contact closing)	≤ 3	≤ 45	≤ 8	-	≤ 6	≤ 50

(1) On all contacts simultaneously, reduction of 30%.

(2) Maximum peak and pulse currents are those currents that can be handled, for a specified time, by the contact. They do not refer to steady or interrupted currents.

(3) For other examples, see electrical life expectancy curves.

(4) Unless specified otherwise, operating times are understood as comprising stabilization of the contact (inclusive of bounces).

(5) Bounces = 5 ms.

Insulation	
Insulation resistance (at 500Vdc) between electrically independent circuits and between these circuits and ground	> 10,000 MΩ
Withstand voltage at industrial frequency between electrically independent circuits and between these circuits and ground between adjacent contacts	2 kV (1 min) - 2.2 kV (1 s) 2 kV (1 min) - 2.2 kV (1 s)
Impulse withstand voltage (1.2/50μs - 0.5J) between electrically independent circuits and between these circuits and ground	5 kV

Mechanical specifications	RGRE12	RGMV12	RGMV13	RMMV12	RMMV13	RMMZ11
Mechanical life expectancy	20x10 ⁶ operations	20x10 ⁶ operations		10x10 ⁶ operations		
Maximum switching rate	Mechanical 3,600 ops. / h	1,800 operations / hour				
Degree of protection	IP40					
Dimensions (mm)	45x50x112 ⁽¹⁾	45x50x112 ⁽¹⁾	45x50x86 ⁽¹⁾	132x58x84 ⁽¹⁾		
Weight (g)	190	320	270	530		

(1) Excluding output terminals



Environmental specifications

Operating temperature	-25 to 55°C
Storage and shipping temperature	-25 to 70°C
Relative humidity	Standard: 75% RH - Tropicalized: 95% RH
Fire behaviour	V0



Standards and reference values

EN 61810-1, EN 61810-2, EN 61810-7 EN 60695-2-10 EN 50082-2 EN 60529	Electromechanical elementary relays Fire behavior Electromagnetic compatibility Degree of protection provided by enclosures
---	--

Unless otherwise specified, products are designed and manufactured according to the requirements of the European and International standards indicated above.
In accordance with EN 61810-1, all items of technical data are referred to ambient temperature 23 °C, atmospheric pressure 96kPa and 50% humidity.
Tolerance for coil resistance, nominal electrical input and nominal power is $\pm 7\%$.



Configurations - Options

TROPICALIZATION	Surface treatment of the coil with protective coating for use with RH 95%.
LEVER FOR MANUAL OPERATION	Allows manual operation of the relay, with the cover closed, using a screwdriver (RMMZ11 only)



Ordering scheme

Product code	Configuration	Label	Type of power supply	Nominal voltage (V) ⁽¹⁾	Finish ⁽²⁾	Keying position code ⁽³⁾
RGRE	12 : 2 CO reed contacts	F	C : Vdc	024 - 048 - 110 125 - 220	T: Tropicalized coil M: Manual operation ⁽⁴⁾	xxx
RGMV	12 : 4 CO contacts 13 : 4 NC contacts					
RMMV	12 : 8 NO contacts 13 : 4 NO contacts + 4 NC contacts					
RMMZ	11 : 8 CO contacts					

Example

RGMV	12	F	C	110		
RGMV12F-C110 = Fast-acting monostable relay with 4 change-over contacts and 110Vdc coil.						
RMMZ	11	F	C	048	T	
RMMZ11F-C048 = Fast-acting monostable relay with 8 change-over contacts and 48Vdc tropicalized coil.						

- (1) Other values on request.
- (2) Optional value. Multiple selection possible (e.g. TM).
- (3) Optional value. Positive mechanical keying is defined according to the manufacturer's model.
- (4) RMMZ11 only.

Wiring diagram

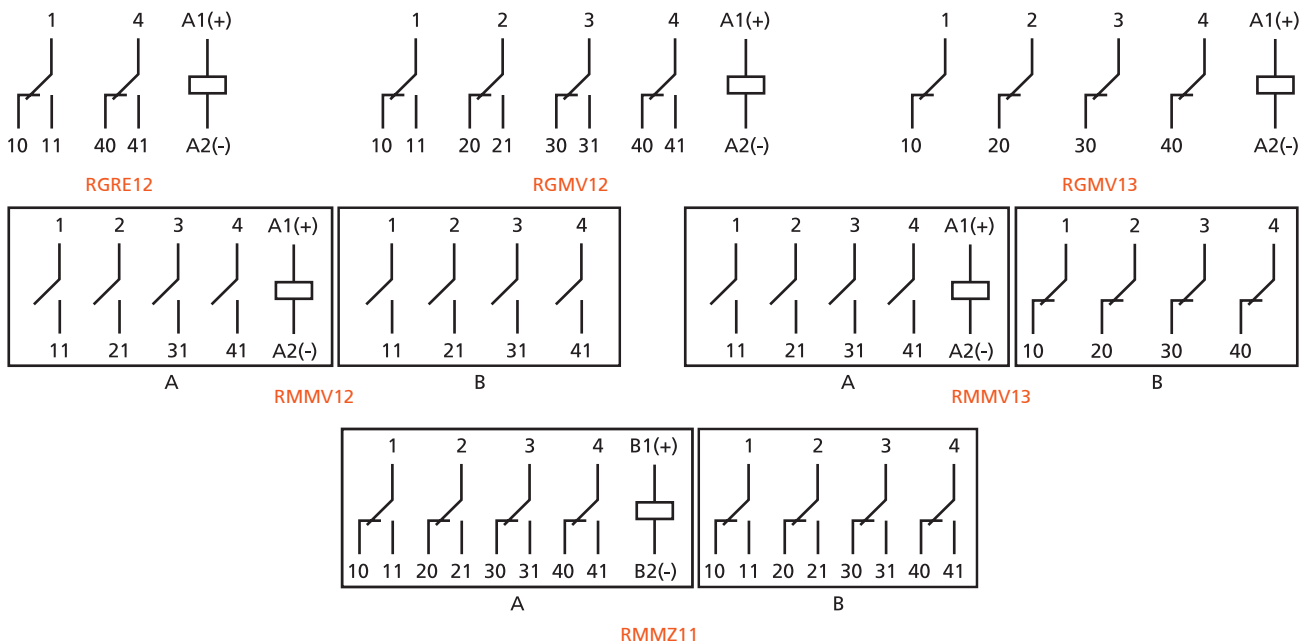

Dimensions

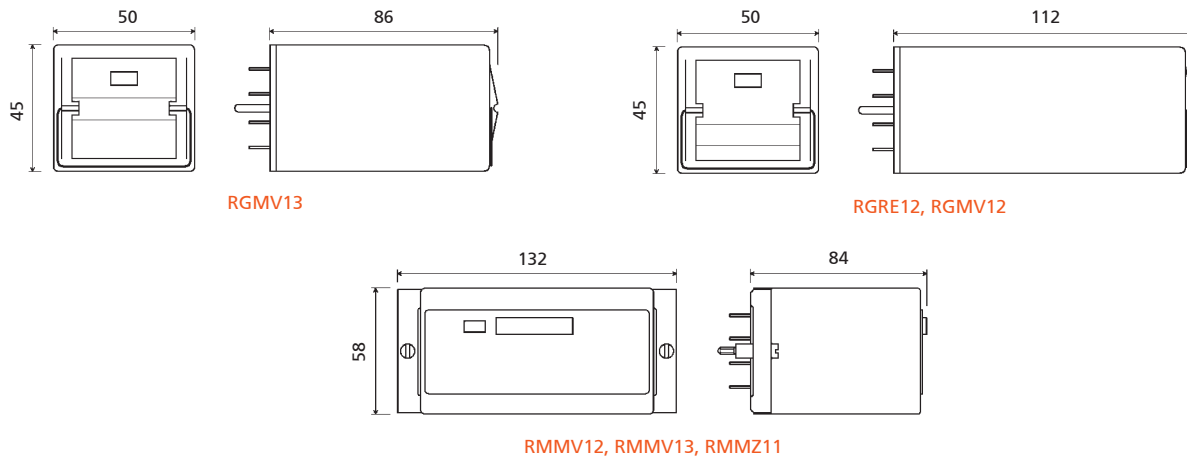

Electrical life expectancy

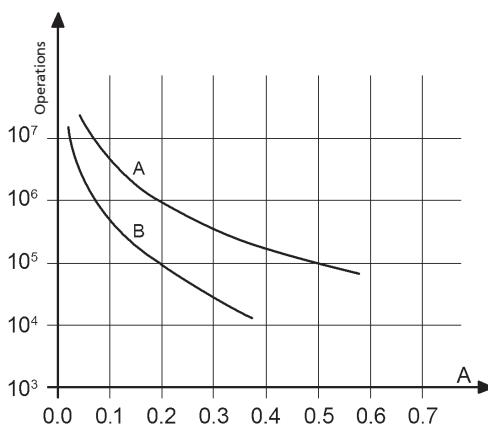

Contact loading: 110Vdc, L/R 40 ms
 Curve A: RMMZ11
 Curve B: RGMV12-13, RMMV12-13

RMMZ11			
U	I (A)	L/R (ms)	Operations
110 Vdc	0.5	40	100,000
110 Vdc	0.6	10	300,000
120 Vdc	0.7	40	100,000
125 Vdc	1.2	0	1,000,000
220 Vdc	0.1	40	100,000
220 Vdc	0.25	10	100,000
U	I (A)	cosφ	Operations
110 Vac	1	1	2,000,000
110 Vac	1	0.5	1,500,000
110 Vac	5	1	1,000,000
110 Vac	5	0.5	500,000
220 Vac	0.5	1	2,000,000
220 Vac	1	0.5	600,000
220 Vac	5	1	650,000
220 Vac	5	0.5	600,000

Switching frequency: 1,200 operations/hour

RGMV12 - 13			
U	I (A)	L/R (ms)	Operations
110Vdc	0.2	40	500,000
220Vdc	0.2	10	80,000
U	I (A)	cosφ	Operations
110 Vac	1	1	1,200,000
110 Vac	1	0.5	1,000,000
110 Vac	5	1	500,000
110 Vac	5	0.5	300,000
220 Vac	0.5	1	1,200,000
220 Vac	1	0.5	500,000
220 Vac	5	1	400,000
220 Vac	5	0.5	300,000

Switching frequency: 1,200 operations/h
 (*) = 600 operations/hour

Sockets and retaining clips		RGRE - RGMV12 - RGMV13			RMMV12 - RMMV13 - RMMZ11
Type of installation	Type of outputs	Sockets	Clip for RGRE/RGMV12	Clip for RGMV13	Sockets
Wall or DIN rail mounting	Screw	PAVG161	VM1222	VM1223	PAVM321
Flush mounting	Double faston (4.8 × 0.8 mm)	PRDG161	VM1222	VM1223	PRDM321
	Screw	PRVG161	VM1222	VM1223	PRVM321

Mounting tips

The preferred mounting position is on the wall, with the relay positioned horizontally in the reading direction on the nameplate. For correct use of the relays, they should be spaced apart by at least 5 mm in the horizontal direction (G series) and 20 mm in the vertical direction (G and M series). This is to allow correct upward dissipation of the heat generated by the coil. Set these distances according to the socket used. Distances can be reduced depending on the environmental conditions during operation, and on the relay duty cycle. For safe and secure operation of G series relays, it is advisable to use retaining clips. Retaining clips are not required for M series relays, as a secure connection is guaranteed by the fixing screws. These same screws also serve to facilitate installation and removal of the relay. To ensure correct use, the screws must be tightened / loosened in alternating sequence, by degrees. No special maintenance is required. Condensation can form inside the relay when powered up and the outside ambient temperature is cold; this is quite normal and does not affect the operation of the relay. The plastic materials of the relay do not possess hygroscopic properties.



RELAYS

FAST-ACTING BISTABLE (LOCK-OUT) RELAYS, 4 - 8 - 12 CONTACTS

RGBV | RMBV

USER SECTORS



Power generation



Nuclear



Power transmission



Rolling Stock



Fixed railway installations



Shipbuilding



Shipbuilding



Heavy industry



RMBV12X

PRODUCT ADVANTAGES

- High speed operation, tripping applications
- High Burden configuration, providing immunity to capacitance discharges
- Plug-in relays
- High performance, compact dimensions, light weight
- Solid and rugged construction for intensive duty
- Self-cleaning knurled contacts, C/O type
- Wide contact gap for a very high breaking capacity, electrical life expectancy and insulation.
- Magnetic arc blow-out as standard
- Wide range of sockets
- Retaining clip for secure relay locking on socket
- Transparent cover, LED as standard and pull-out handle

DESCRIPTION

RGBV and RMBV relays are highly reliable, high performance products, suitable for applications in very harsh and disturbed environments, such as protection, command and control systems for HV electrical substations or power stations.

The range includes relays with 4, 8 and 12 contacts.

These lockout (latching) relays have 2 stable positions; contacts are able to hold their position after energizing the "SET" coil or the "RESET" coil.

All models are equipped with an automatic coil cut-off system, designed to have no power consumption once the operation is completed.

A manual lever allows the relays to be operated manually.

These relays are designed for **circuit breaker tripping applications**, where **fast-acting** contact is essential in order to **minimize the total trip time** and avoid, in case of emergency situation, damages to the **transmission station** equipments.

The **high speed** in operation, the high breaking capacity and the **ability also to switch very low loads** (few mA) make them suitable for use in demanding applications such as:

- Duplication of HV/MV protection outputs
- Direct action on HV/MV primary equipment
- Trip alarms transmission

The **knurled contact surface** ensures excellent self-cleaning, and a lower ohmic resistance thanks to the various points of electrical contact, while also improving the electrical life expectancy of the component.

The contacts are designed to achieve **remarkable performance both for high, inductive loads and very low loads**. Contact is able to switch from 10mA – 10V without gold-plating the contacts.

Magnetic arc blow-out helps to increase the breaking capacity: the relay can manage heavy duty loads with intensive switching frequency.

The "High burden" (HB) configuration provides immunity against capacitance (currents and power) discharge to the coil, in order to avoid relay operations in the event of transients due to extensive wiring, for example.

Models	Number of contacts	HIGH BURDEN ⁽¹⁾ configuration	Manual operation	Operating time Pick-up (ms)
RGBV14X	4	-	Option	≤ 10 ms
RGBV16X	4	✓		
RMBV12X	8	-	✓	≤ 10 ms
RMBV14X	8	✓		
RMBV15	12	-	Option	≤ 10 ms
RMBV16	12	✓		

(1) HIGH BURDEN Configuration: for the operating and the specifications refer to the paragraph "COIL DATA - HIGH BURDEN Configuration" (see the table below).

FOR PRODUCT CODE CONFIGURATION , SEE THE "ORDERING SCHEME" TABLE

COIL DATA - STANDARD Configuration	4 CO	8 CO	12 CO
Nominal voltages at Un	DC: 24-48-110-125-220V / AC: 230V		
Consumption at Un	< 22 W	< 35 W	≤ 75 W
Current AVG peak at pick-up ⁽¹⁾	24Vdc < 0.8A / 20ms 48 - 110 - 125Vdc: < 0.3A / 20ms 220Vdc: < 0.1A / 20ms		24Vdc: < 1.2A / 20ms 48 - 110 - 125Vdc: < 0.5A / 20ms 220Vdc: < 0.1A / 20ms
Operating range	DC: 80 ÷ 110% Un / AC: 80 ÷ 110%		
Type of duty	Continuous		

Coil data HIGH BURDEN configuration	4 CO	8 CO	12 CO
Nominal voltages at Un	DC: 24 - 48 - 110 - 125 - 220V		
AVG consumption at Un (only while switching)	< 22 W	< 35 W	≤ 75 W
Peak consumption	24 - 48Vdc: 300 W 110 - 125 - 220Vdc: 300 W		
Immunity to capacitive discharge	10 µF @ 120% Un across the coil		
Operating range	80 ÷ 110% Un		
Type of duty	Continuous		
Drop-out voltage	DC: > 5% Un		

The **CONFIGURATION HIGH BURDEN** provides higher security in plant control system, avoiding unwanted relay operation due to capacitive discharge currents, for example in case of an earth fault in long DC cables.

A typical application is where the initiating contact may be remote from tripping relay.

HIGH BURDEN Tripping Relays is designed to withstand a "10µF capacitor discharge test".

- Relay will not operate when a 10 µF capacitor, charged @ 120% Un, is applied across the coil.

While switching, high energy is required. After operation, the high coil burden is reduced to a very low value, ensuring energy saving and avoiding overload on the power supply circuit or station battery.

An electronic circuit acts as a coil voltage regulator and controls the duration of the burden.

Contact data		4 CO	8 CO	12 CO
Current	Nominal ⁽¹⁾	10A		
	Maximum pulse ⁽²⁾	20A for 1min 40A for 1s 150A for 10ms		
Example of electrical life ⁽³⁾		1A - 110Vdc - L/R 0ms - 350,000 operations 0.5A - 220Vdc - L/R 0ms - 300,000 operations		
Making capacity		30A (for 200ms) - 110Vdc - L/R 0ms: 2,000 operations		
Minimum load ⁽⁴⁾	Standard contacts	200mW (10V, 10mA)		
	Gold-plated contact ⁽⁵⁾	50mW (5V, 5mA)		
Maximum breaking voltage		250Vdc / 350Vac		
Contact material		AgCdO		
Operating time at Un (ms) ⁽⁶⁾	Pick-up ms	Vdc: ≤ 10	Vac: ≤ 10	
	Drop-out ms	Vdc: ≤ 10	Vac: ≤ 10	

(1) On all contacts simultaneously, reduction of 30%.

(2) The maximum pulse currents are those currents that can be handled, for a specified time, by the contact. They do not refer to make or break currents.

(3) For other examples, see electrical life expectancy curves.

(4) Values referred to a new product, measured in laboratory.

The ability to maintain this performance over the time depends on the environmental conditions and the contact' frequency use.

The use of gold plated contacts is recommended in the case of very low loads.

(5) A gold contact, if subjected to high loads, degrades superficially. In this case, the characteristics of the standard contact must be considered. This does not affect the operation of the relay.

(6) Unless specified otherwise, the operating times are expressed excluding bounces.

Only for Vac power supply: actual value may increase of max 5ms (pick-up, worst case) or 10ms (drop-out, worst case). It depends on the sinusoid front (rising or falling) while energizing or de-energizing.

Insulation		
Insulation resistance (at 500Vdc) between electrically independent circuits and between these circuits and ground		> 1,000 MΩ
Dielectric withstanding voltage at industrial frequency between electrically independent circuits and ground between adjacent contacts		2 kV (1 min) - 2.2 kV (1 s) 2 kV (1 min) - 2.2 kV (1 s)
Impulse withstand voltage (1.2/50µs - 0.5J) between electrically independent circuits and between these circuits and ground between open contact parts		5 kV 3 kV

Mechanical specifications		4 CO	8 CO	12 CO
Mechanical life expectancy		10x10 ⁶ operations		
Maximum switching rate	Mechanical	3,600 operations / h		
Degree of protection (with relay mounted)		IP40		
Dimensions (mm) ⁽¹⁾		45x50x86	45x90x100	58x188x84
Weight (g)		270	400	810

(1) Output terminals excluded.

Environmental characteristics		
Operating temperature		-25 ÷ +70°C
Storage and shipping temperature		-40 ÷ +85°C
Relative humidity		Standard: 75% UR - Tropicalized: 95% UR
Fire behaviour		V0

Standards and reference values		
EN 61810-1, EN 61810-2, EN 61810-7 EN 60695-2-10 EN 60529 EN 61000		Electromechanical elementary relays Fire behaviour Degree of protection provided by enclosures Electromagnetic compatibility



Configurations - Options

TROPICALIZATION	Surface treatment of the coil with protective coating for use with RH 95%.
GOLD PLATING	Surface treatment of the contacts, blades and output terminals with gold-cobalt alloy $\geq 2\mu$. This treatment ensures long-term ability of the contact to conduct lower currents.
LEVER FOR MANUAL OPERATION	Allow to manual operating the relay (available only for the RMMV11 and RMMV17 models)
HIGH BURDEN (HB)	The HB "High Burden" Configuration provide immunity to capacitance discharge currents & power to the coil, in order to avoid relay operations, for example in case of transients coming from extensive wiring.



Ordering scheme

Product code	Configuration A	Configuration B	Label	Type of power supply	Nominal voltage (V)	Finish ⁽¹⁾
RGBV	1: Standard 4: Gold Plating	4X: 4 contacts 6X: 4 contacts with HB	F	C: Vdc A: Vac	Vdc 024 - 048 - 110 - 125 Vac 230 ⁽²⁾	T: Tropicalized coil M: Lever for manual operation
RMBV	1: Standard 4: Gold Plating	2X: 8 contacts 4X: 8 contacts with HB		C: Vdc A: Vac	Vdc 024 - 048 - 110 - 125 Vac 230 ⁽²⁾	T: Tropicalized coil (lever for manual operation always included)
RMBV	1: Standard 4: Gold Plating	5: 12 contacts 6: 12 contacts with HB		C: Vdc A: Vac	Vdc 024 - 048 - 110 - 125 Vac 230 ⁽²⁾	T: Tropicalized coil M: Lever for manual operation

(1) Optional value. Possible the multiple choice (Ex. TM)

(2) NOT AVAILABLE FOR HB Configuration

Example	RGBV	1	6X	C	024	
	RGBV16X-C024= Relay with standard contacts, 4 C/O, High Burden configuration, 24Vdc coil					
	RMBV	4	5		230	M
	RMBV45-A230/M= Relay with gold plating, 12 C/O, 230Vac coil, lever for manual operation					

Wiring diagram

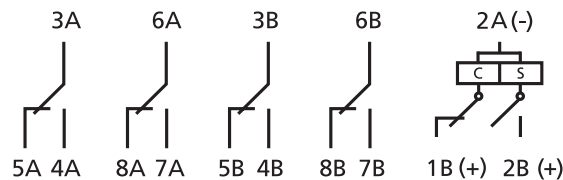

RGBV14X - RGBV16X

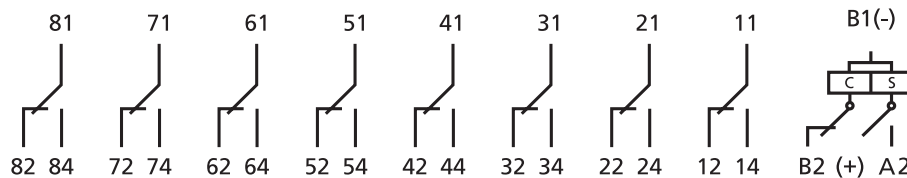

RMBV12X - RMBV14X

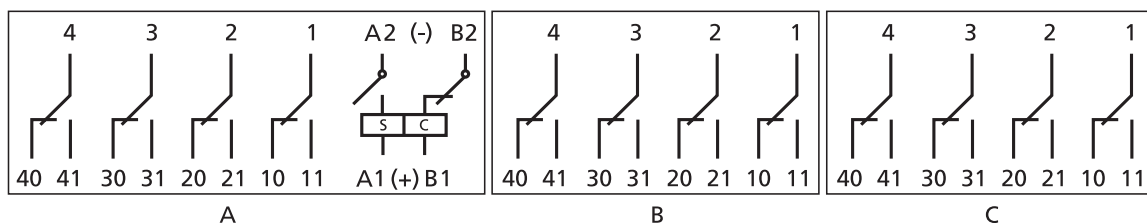

RMBV15 - RMBV16

Dimensions

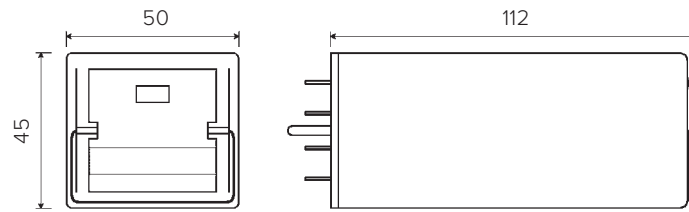

RGBV14X - RGBV16X

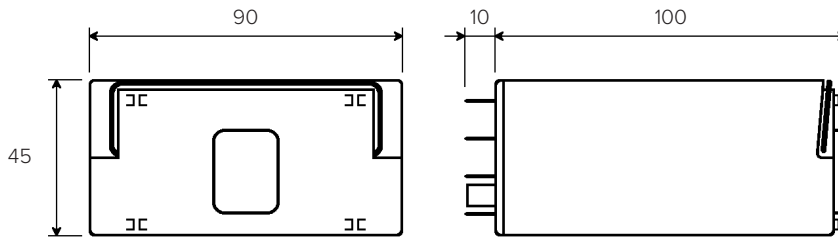

RMBV12X - RMBV14X

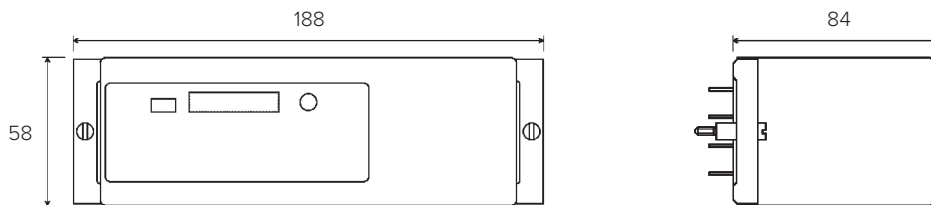

RMBV15 - RMBV16

Electrical life expectancy

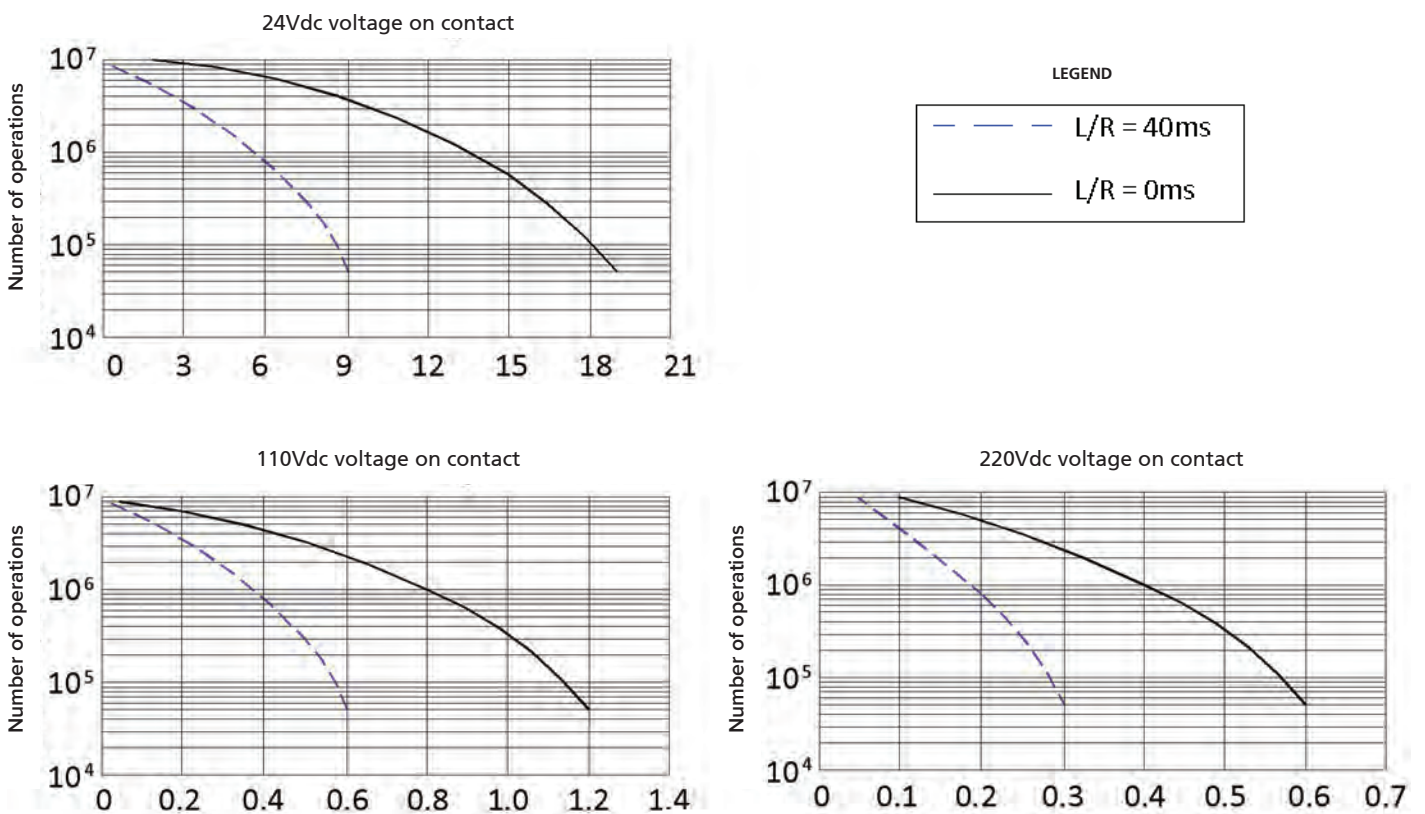

Sockets		RGMV.x6X - RGMV.x7X	RMMVx2X - RMMVx6X	RMMVx1 - RMMVx7
Type of installation	Type of outputs	Model		
Wall or DIN H35 rail mounting	Screw	48BIP20-I DIN	96IP20-I DIN	PAVM481
	Spring clamp	PAIR160	PAIR320	-
Flush mounting	Screw	-	-	PRVM481
	Spring clamp	PRIR160	PRIR320	-
	Double faston (4.8 x 0.8 mm)	ADF2	ADF4	PRDM481

Retaining clip	RGMV.x6X - RGMV.x7X	RMMVx2X - RMMVx6X	RMMVx1 - RMMVx7
Sockets models	Modèle		
48BIP20-I DIN, 96IP20-I DIN	RG48	RMC48 ⁽¹⁾	-
PAIR160, PAIR320			-
ADF2, ADF4			-
PAVM481, PRVM481, PRDM481	-	-	Fixing with integrated screws

(1) 2 pieces for each relay

MONOSTABLE INSTANTANEOUS
INSTANTANEOUS MONOSTABLE WITH FORCIBLY GUIDED CONTACTS
BISTABLE
FAST-ACTING (MONOSTABLE AND BISTABLE)
TIME DELAY (ON PICK-UP OR DROP-OUT)
TIME DELAY WITH FORCIBLY GUIDED CONTACTS
MEASUREMENT
SOCKET NUMBERING EXPLANATIONS
FRONT CONNECTION
BACK CONNECTION
PCB MOUNT
RETAINING CLIPS
KEYING



RELAYS

FAST-ACTING BISTABLE RELAYS WITH 3-7 CONTACTS

RGBZ10-11 | RMBZ30 SERIES fast-acting

USER SECTORS



Power generation



Nuclear



Power transmission



Rolling stock



Fixed railway installations



Shipbuilding



Shipbuilding



Heavy industry



RGBZ10



RMBZ30

PRODUCT ADVANTAGES

- Fast-acting bistable relay
- Solid and rugged construction for heavy or intensive duty
- Very long electrical life expectancy and exceptional endurance
- Self-cleaning knurled contacts
- Direct current operation
- Retaining clip or fixing screws for secure locking of relay to socket
- Transparent cover, pull-out handle or fixing/pulling screws
- Label holder in cover for customer's use
- Positive mechanical keying for relay and socket

DESCRIPTION

Fast-acting bistable relays are available in 3 models with 3, 4 and 7 change-over contacts. This family of relays is able to guarantee high speed switching of contacts. Sharing the same basic electromechanical design as relays of the G series, they offer the same specifications and benefits. These relays can be operated off a d.c. power supply.

In an instantaneous bistable relay, the closure of an NO contact takes normally between 30 and 60 ms, depending on the particular product specifications. In contrast, a fast-acting relay is able to close the contact in a time of between 10 and 20 ms.

The operating time is measured from the moment when the coil is energized until completion of the change in status and stabilization of the contact, including bounces. A 'bounce' is an intermediate position assumed by the contact during the course of stabilization in its final position. It is advisable to discuss this aspect thoroughly with the manufacturer, when selecting the component. The contacts used are of a type designed to give good levels of performance both with **high and strongly inductive d.c. loads**, and with **particularly low loads** such as interface signals; inclusion of the magnetic arc blow-out function (optional) helps to achieve a considerable increase in breaking capacity.

Knurled contacts ensure not only have better **self-cleaning** characteristics, but also lower ohmic resistance thanks to multiple points of electrical connection, thereby extending the electrical life expectancy of the component.

Typical sectors of use are among the most demanding, such as, for example, electricity generating stations, electrical transformer stations, fixed equipment for railways, or industries using continuous production processes (chemical and petrochemical, rolling mills, cement factories, etc.). The performance and reliability of the product have secured its approval with ENEL and other multi-utilities.

Fast-acting relays are often incorporated into circuits of key importance, such as those providing protection and breaker functions on a power line in the event of faults occurring. With this in mind, operating speed is an essential parameter for electrical system designers. The contacts are connected to multifunction digital protection devices or recording instruments (disturbance recorders).

Like all our relays, the models in the fast-acting bistable series are assembled as part of a controlled manufacturing process in which every step of production is verified by the next step in succession. In effect, each relay is calibrated and tested individually, by hand, in such a way as to guarantee top reliability.

Models	Type	Number of contacts	Nominal current	Operating time ⁽¹⁾	
				Pick-up	Drop-out
RGBZ10	Bistable	3	12 A	≤ 8 + 4 ms	≤ 9 + 25 ms
RGBZ11	Bistable	4	12 A	≤ 8 + 7 ms	≤ 9 + 25 ms
RMBZ30	Bistable	7	10 A	≤ 10 + 8 ms	≤ 10 + 35 ms

(1) Operating times are expressed as time of first contact + bounce times.

FOR CONFIGURATION OF PRODUCT CODE, SEE "ORDERING SCHEME" TABLE

Coil specifications	RGBZ10	RGBZ11	RMBZ30
Nominal voltages Un	DC: 24-48-110-125-220 ⁽¹⁾		
Consumption at Un (DC/AC)	18 W ⁽²⁾		36 W ⁽²⁾
Operating range	DC: 80...120% Un		
Type of duty	Continuous		

Minimum control pulse 50ms.

(1) Other values on request.

(2) During latch and unlatch. Power consumption is zero on completion of the operating cycle, as the coil de-energizes automatically.

Contact specifications	RGBZ10	RGBZ11	RMBZ30	
Number and type	3 CO, form C	4 CO, form C	7 CO, form C	
Current	Nominal ⁽¹⁾		12 A	
	Maximum peak ⁽²⁾		20A for 1min - 40A for 1s	
	Maximum pulse ⁽²⁾		150A for 10ms	
Example of electrical life expectancy ⁽³⁾	0.5A - 110 Vdc - L/R 40ms - 10 ⁵ operations - 1,800 operations/hour			
Minimum load	200 mW (10 V, 10 mA)			
Maximum breaking voltage	350 VDC / 440 VAC			
Contact material	AgCdO			
Operating time at Un (ms) ⁽⁴⁾	RGBZ10	RGBZ11	RMBZ30	
	Pick-up (NO contact closing)	≤ 8 + 4	≤ 8 + 7	≤ 10 + 8
	Drop-out (NC contact closing)	≤ 9 + 25	≤ 9 + 25	≤ 10 + 35

(1) On all contacts simultaneously, reduction of 30%.

(2) Maximum peak and pulse currents are those currents that can be handled, for a specified time, by the contact. They do not refer to steady or interrupted currents.

(3) For other examples, see electrical life expectancy curves.

(4) Operating times are expressed as time of first contact + bounce times.

Insulation	
Insulation resistance (at 500Vdc)	
between electrically independent circuits and between these circuits and ground	> 10,000 MΩ
between open contact parts	> 10,000 MΩ
Withstand voltage at industrial frequency	
between electrically independent circuits and between these circuits and ground	2 kV (1 min) - 2.2 kV (1 s)
between open contact parts	2 kV (1 min) - 2.2 kV (1 s)
between adjacent contacts	2 kV (1 min) - 2.2 kV (1 s)
Impulse withstand voltage (1.2/50μs - 0.5J)	
between electrically independent circuits and between these circuits and ground	5 kV
between open contact parts	4 kV

Mechanical specifications	RGBZ10	RGBZ11	RMBZ30
Mechanical life expectancy	20x10 ⁶ operations		
Maximum switching rate	900 operations/hour		
Degree of protection	IP40		
Dimensions (mm)	45x50x86 ⁽¹⁾	45x50x112 ⁽¹⁾	132x58x86 ⁽¹⁾
Weight (g)	280	370	450

(1) Excluding output terminals



Environmental specifications

Operating temperature	-25 to 55°C
Storage and shipping temperature	-25 to 70°C
Relative humidity	Standard: 75% RH - Tropicalized: 95% RH
Fire behavior	V0



Standards and reference values

EN 61810-1, EN 61810-2, EN 61810-7 EN 60695-2-10 EN 50082-2 EN 60529	Electromechanical elementary relays Fire behavior Electromagnetic compatibility Degree of protection provided by enclosures
---	--

Unless otherwise specified, products are designed and manufactured according to the requirements of the European and International standards indicated above. In accordance with EN 61810-1, all items of technical data are referred to ambient temperature 23 °C, atmospheric pressure 96kPa and 50% humidity. Tolerance for coil resistance, nominal electrical input and nominal power is $\pm 7\%$.



Configurations - Options

TROPICALIZATION	Surface treatment of the coil with protective coating for use with RH 95%.
LEVER FOR MANUAL OPERATION	Allows manual operation of the relay, with the cover closed, using a screwdriver (except RGBZ11).



Ordering scheme

Product code	Configuration	Label	Type of power supply	Nominal voltage (V) ⁽¹⁾	Finish ⁽²⁾	Keying position code ⁽³⁾
RGBZ	10: 3 CO contacts 11: 4 CO contacts	F	C: Vdc	024 - 048 - 110 125 - 132 - 144 220	T: Tropicalized coil	xxx
RMBZ	30: 7 CO contacts				M: Manual operation ⁽⁴⁾	

Example

RGBZ	10	F	C	110		
RGBZ10F-C110 = Fast-acting bistable relay with 3 change-over contacts and 110Vdc coil.						
RMBZ	30	F	C	048	T	
RMBZ30F-C048/T = Fast-acting bistable relay with 7 change-over contacts and 48Vdc tropicalized coil.						

- (1) Other values on request.
- (2) Optional value. Multiple selection possible (e.g. TM).
- (3) Optional value. Positive mechanical keying is defined according to the manufacturer's model .
- (4) RMBZ30 only.

Wiring diagram

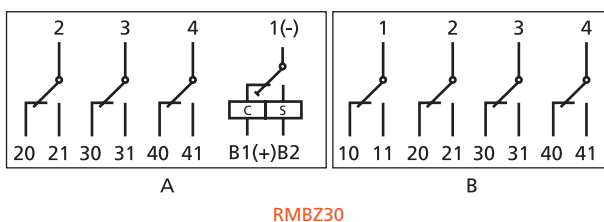

Dimensions

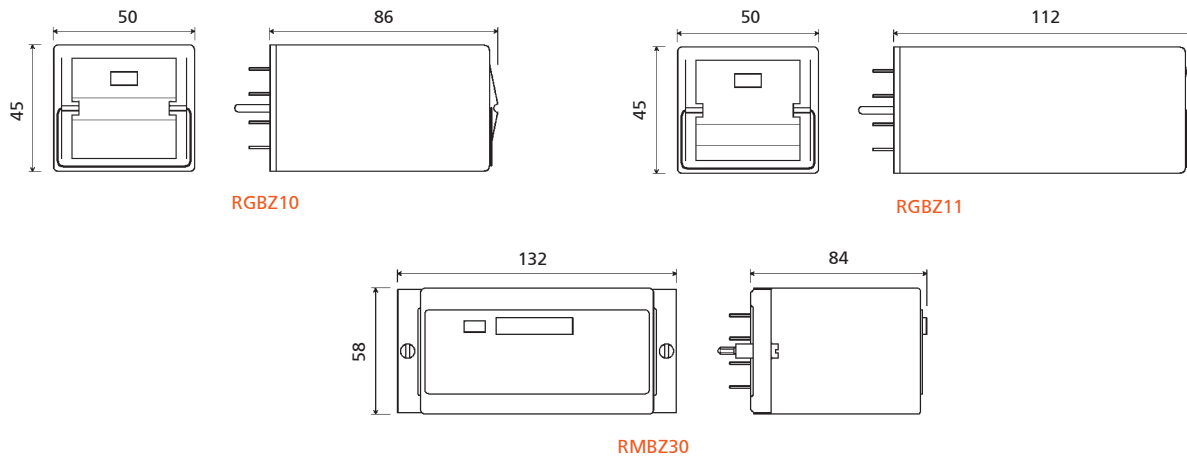

Electrical life expectancy

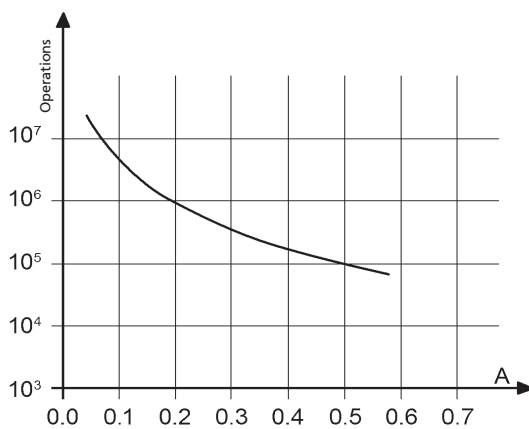

Contact loading: 110Vdc, L/R 40 ms

U	I (A)	L/R (ms)	Operations
110 Vdc	0.5	40	100,000
110 Vdc	0.6	10	300,000
120 Vdc	0.7	40	100,000
125 Vdc	1.2	0	1,000,000
220 Vdc	0.1	40	100,000
220 Vdc	0.25	10	100,000
U	I (A)	cosφ	Operations
110 Vac	1	1	2,000,000
110 Vac	1	0.5	1,500,000
110 Vac	5	1	1,000,000
110 Vac	5	0.5	500,000
220 Vac	0.5	1	2,000,000
220 Vac	1	0.5	600,000
220 Vac	5	1	650,000
220 Vac	5	0.5	600,000

Switching frequency: 1,200 operations/hour

Sockets and retaining clips		RGBZ10 - RGBZ11			RMBZ30
Type of installation	Type of outputs	Socket	Clip for RGBZ10	Clip for RGBZ11	Socket
Wall or DIN rail mounting	Screw	PAVG161	VM1222	VM1223	PAVM321
Flush mounting	Double faston (4.8 × 0.8 mm)	PRDG161	VM1222	VM1223	PRDM321
	Screw	PRVG161	VM1222	VM1223	PRVM321

Mounting tips

The preferred mounting position is on the wall, with the relay positioned horizontally in the reading direction on the nameplate. For safe and secure operation of G series relays, it is advisable to use retaining clips. Retaining clips are not required for M series relays, as a secure connection is guaranteed by the fixing screws. These same screws also serve to facilitate installation and removal of the relay. To ensure correct use, the screws must be tightened / loosened in alternating sequence, by degrees.

No special maintenance is required.

Condensation can form inside the relay when powered up and the outside ambient temperature is cold; this is quite normal and does not affect the operation of the relay. The plastic materials of the relay do not possess hygroscopic properties.



RELAYS

FAST-ACTING MONOSTABLE RELAYS WITH 6 CONTACTS

RV SERIES

USER SECTORS



Power generation



Nuclear



Power transmission



Rolling Stock



Fixed railway installations



Shipbuilding



Shipbuilding



Heavy industry

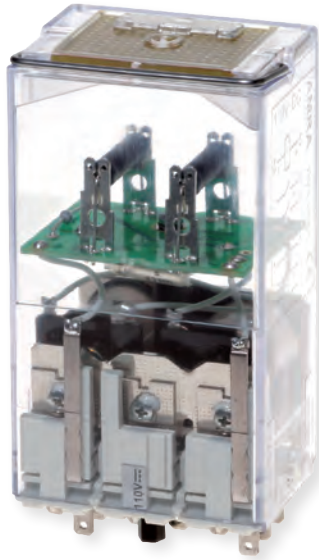

RV

PRODUCT ADVANTAGES

- Plug-in monostable type fast-acting relay
- Ultra fast switching $\leq 6\text{ms}$, including bounces
- Solid and rugged construction
- Long life expectancy
- High electromagnetic interference immunity
- Separate arc breaking chambers
- Magnetic arc blow-out standard
- Independent and self-cleaning contacts
- Direct current operation
- Excellent shock and vibration resistance
- Wide range of sockets
- Retaining clip for secure locking of relay on socket
- Transparent cover, pull-out handle
- Positive mechanical keying for relay and socket

DESCRIPTION

The **RV series** is a range of 4 monostable relays able to guarantee **high speed switching**. These relays have 6 contacts rated 5 A, with different configurations including all normally open, or mixed (NO+NC). The relays are assembled with coils sized in such a way as to obtain magnetic flux of particularly high strength when powered up.

Accordingly, optimization of the ferromagnetic circuit enables **ultra fast switching of the contacts**. The relay is immune to strong electromagnetic interference, typical of high voltage electricity distribution stations.

The **self-cleaning contacts are independent**, being anchored neither one to another nor to a common operating mechanism. Positioned in separate chambers, they enable **better breaking of the arc**. In addition, they are equipped with magnetic arc blowout, guaranteeing a particularly efficient break of direct current loads. The common contact is mounted to a separate return device, consisting in a flexible blade designed to ensure uniformity of the pressures on break contacts.

Excellent electrical and mechanical performance levels allow the product to be used in the most demanding of sectors such as, for example, control and signalling functions in electricity generating stations, electrical transformer stations or heavy industry. The most common application is as a trip relay downstream of high voltage line protection systems.

The construction of the relays and careful choice of the materials are such that they ensure **long life and considerable ruggedness** even in harsh operating environments.

The performance and reliability of the component have secured its **approval with ENEL and other multi-utilities**.

Models	Number of NO contacts	Number of NC contacts
RV LV16/1	6	0
RV LV16/2	4	2
RV LV16/3	3	3
RV LV16/5	2	4

FOR CONFIGURATION OF PRODUCT CODE, SEE "ORDERING SCHEME" TABLE

Coil specifications

Nominal voltages Un	DC: 110-125
Max. consumption at Un (DC)	< 7W
Operating range	80...110% Un
Type of duty	Continuous
Drop-out voltage ⁽¹⁾	> 5% Un

(1) Limit value for supply voltage, expressed as % of the nominal value, beneath which the relay is certainly de-energized.

Contact specifications	RV LV16/1	RV LV16/2	RV LV16/3	RV LV16/5
Nombre et type	6 NO	4 NO + 2 NC	3 NO + 3 NC	2 NO + 4 NC
Current	5 A			
Nominal ⁽¹⁾	10 A			
Maximum peak (1 min) ⁽²⁾	100 A			
Maximum pulse (10 ms) ⁽²⁾				
Example of electrical life expectancy 1,800 operations / h	opening 0.3A - 110Vdc - L/R = 40ms: 10 ⁵ operations closing 30A - 110Vdc - L/R = 0ms: 2,000 operations			
Minimum load	500 mW (20V, 20 mA)			
Standard contacts	100 mW (10V, 5 mA)			
Gold-plated contact ⁽³⁾				
Maximum breaking voltages	250 Vdc / 350 Vac			
Contact material	AgCu			
Operating time at Un (ms) ⁽⁴⁾	≤ 6			
Pick-up (NO contact closing / NC contact opening)				

(1) Nominal current: on all contacts simultaneously, reduction of 30%.

(2) The max. peak and pulse currents are those currents that can be handled, for a specified time, by the contact. They do not refer to steady or interrupted currents.

(3) Specifications of contacts on new relay

a) Plating material: gold-nickel alloy (>6μ)

b) When the gold-plated contact is subject to heavy loads, it will be degraded on the surface. In such case, the characteristics of the standard contact should be taken into consideration. This does not impair relay operation.

(4) Unless specified otherwise, the operating time signifies until stabilization of the contact (including bounces).

Insulation

Insulation resistance (at 500Vdc)	
between electrically independent circuits and between these circuits and ground	> 1,000 MΩ
between open contact parts	> 1,000 MΩ
Withstand voltage at industrial frequency	
between electrically independent circuits and between these circuits and ground	2 kV (1 min) - 2.2kV (1 s)
between open contact parts	1 kV (1 min) - 1.1kV (1 s)
between adjacent contacts	2,5 kV (1 min) - 3kV (1 s)
Impulse withstand voltage (1.2/50μs - 0.5J)	
between electrically independent circuits and between these circuits and ground	5 kV
between open contact parts	3 kV

Mechanical specifications

Mechanical life expectancy	10 ⁶ operations
Maximum switching rate	900 operations/hour
Mechanical	
Degree of protection (with relay mounted)	IP40
Dimensions (mm)	45x60x109 ⁽¹⁾
Weight (g)	~ 300

(1) Excluding output terminals



Environmental specifications

Operating temperature	-10 to +55 °C
Storage and shipping temperature	-25 to +70 °C
Relative humidity	Standard: 75% RH, Tropicalized: 95% RH
Resistance to vibrations	5g - 10 to 55 Hz - 1 min.
Resistance to shock	20g - 11ms
Fire behavior	V0



Standards and reference values

EN 61810-1, EN 61810-2, EN 61810-7	Electromechanical elementary relays
EN 60695-2-10	Fire behavior
EN 61000	Electromagnetic compatibility
EN 60529	Degree of protection provided by enclosures

Unless otherwise specified, products are designed and manufactured according to the requirements of the European and International standards indicated above. In accordance with EN 61810-1, all items of technical data are referred to ambient temperature 23 °C, atmospheric pressure 96kPa and 50% humidity. Tolerance for coil resistance, nominal electrical input and nominal power is $\pm 7\%$.



Configurations - Options

P2	Tropicalization of the coil with epoxy resin for use with 95% RH (@ T 50 °C). This treatment also protects the coil against corrosion which could occur by combination of the humidity with certain chemical agents, such as those found in acid atmospheres (typical of geothermal power stations) or saline atmospheres.
P4GEO	Gold plating of contacts with gold-nickel alloy, thickness $\geq 6\mu$. This treatment ensures long-term capacity of the contact to conduct lower currents in harsh ambient conditions such as acid atmospheres (typical of geothermal power stations) or saline atmospheres.
P5GEO	P4GEO gold-plating of contacts + P2 coil tropicalization.



RV Ordering scheme

Product code	Number of contacts	Configuration A	Configuration B	Label	Type of power supply	Nominal voltage (V)	Keying position ⁽²⁾
RVLV16/1	6 NO	1: Standard	0: Standard	F	C: Vdc	110 - 125	XXX
RVLV16/2	4 NO + 2 NC		2: P2				
RVLV16/3	3 NO + 3 NC		4: P4 GEO				
RVLV16/5	2 NO + 4 NC		5: P5 GEO				

Example	RVLV16/1	1	2	F	C	110		
	RVLV16/112F-C110 : RV relay with 6 NO contacts, ENEL-approved according to LV16 specification, nominal voltage 110Vdc, P2 finish							
	RVLV16/5	1	0	F	C	110		
	RVLV16/510F-C110 : RV relay with 2 NO contacts + 4 NC contacts, ENEL-approved according to LV16 specification, nominal voltage 110Vdc							

(1) This product is available only in the ENEL type-approved version, according to LV15/LV16 specification. The designation "LV16/x" contained in the product code identifies the type-approved model.

For a full list of ENEL compliant and type-approved products, refer to the dedicated catalog "STATIONS SERIES"

(2) Optional value. Mechanical keying is applied according to the manufacturer's coding.

Wiring diagram

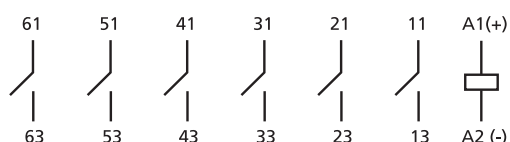

RV LV16/1

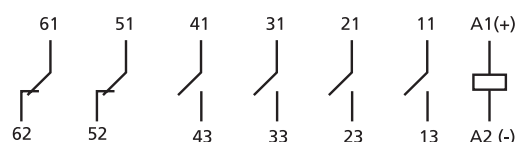

RV LV16/2

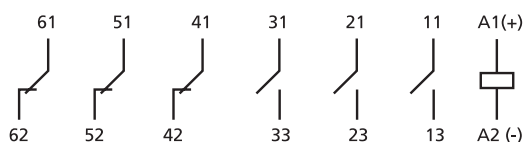

RV LV16/3

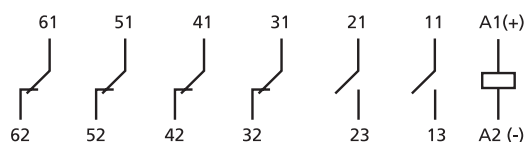

RV LV16/5

Dimensions

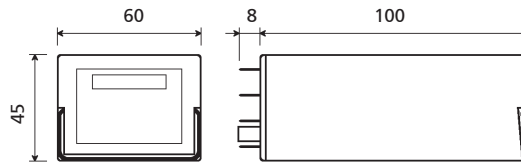

RV

Sockets and retaining clips	RV	
Number of terminals (standard dimensions 5x0.8mm)	14	Retaining clip
For wall or rail mounting		
Spring clamp, wall or DIN H35 rail mounting	PAIR240	RL48
Screw, wall or DIN H35 rail mounting	78BIP20-I DIN	RL48
Screw, wall mounting	78BL	RL48
Double faston, wall mounting	78L	RL48
For flush mounting		
Double faston (4.8 × 0.8 mm)	ADF3	RL48
Screw	73IL ⁽¹⁾	RL43

(1) Insert the clip before fastening the socket on the panel.
For more details, see specifications of mounting accessories.

Mounting tips

The preferred mounting position is on the wall, with the relay positioned horizontally in the reading direction on the nameplate. For correct use of the relays, they should be spaced apart by at least 5 mm in the horizontal direction and 20 mm in the vertical direction. This is to allow correct upward dissipation of the heat generated by the coil. Set these distances according to the socket used. Distances can be reduced depending on the environmental application conditions and on the relay duty cycle.

For safe and secure operation, it is advisable to use retaining clips.

No special maintenance is required.

Condensation can form inside the relay when powered up and the outside ambient temperature is cold; this is quite normal and does not affect the operation of the relay. The plastic materials of the relay do not possess hygroscopic properties.

RELAYS

RELAYS

RELAYS

RELAYS

RELAYS

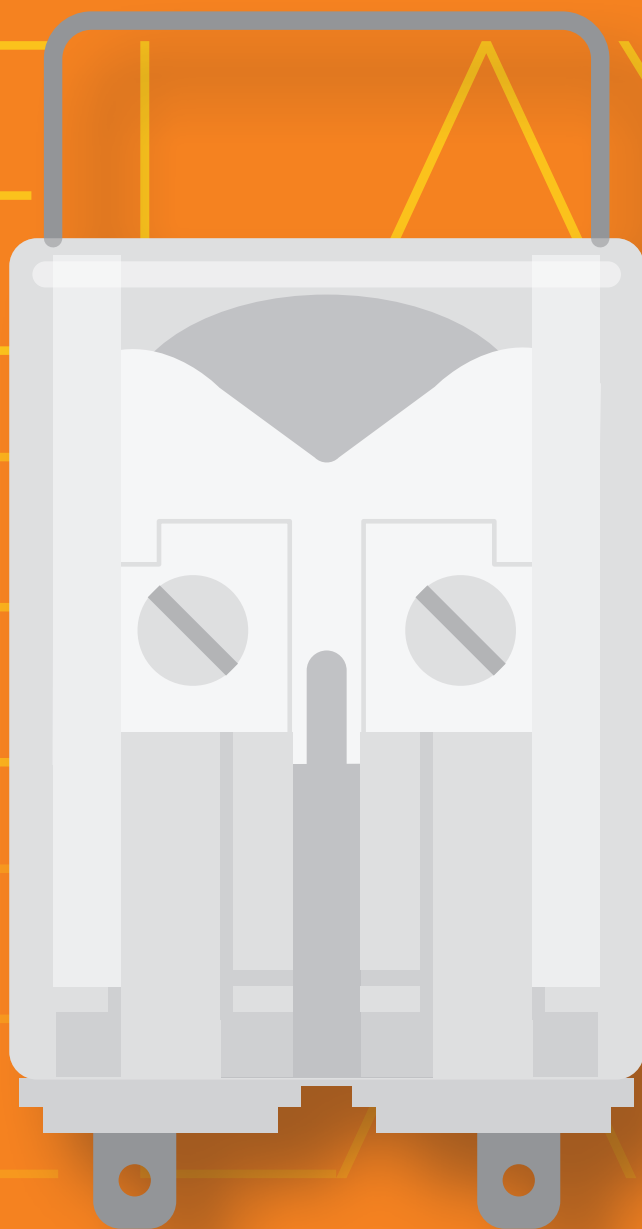

TIME DELAY RELAYS (ON PICK-UP OR DROP-OUT), LOGIC FUNCTION



RELAYS

MONOSTABLE MULTISCALE TIMER RELAYS WITH 4 CONTACTS

RDT SERIES

USER SECTORS



Power generation



Nuclear



Power transmission



Rolling stock



Fixed railway installations



Shipbuilding



Shipbuilding



Heavy industry



RDT

PRODUCT ADVANTAGES

- Plug-in relay with time delay on pick-up or on drop-out
- Only model programmable on pick-up or on drop-out
- High performance, compact dimensions
- Wide time setting range from 0.1s to more than 16 hours, great accuracy over the entire adjustment range
- Led optical indicators monitoring power supply and timer status
- Magnetic arc blow-out for higher breaking capacity
- Self-cleaning knurled contacts
- Relay coupled automatically to socket, with no need for a retaining clip
- Operation with d.c. and/or a.c. power supply
- Wide variety of configurations and customizations
- Transparent cover, pull-out handle
- Label holder in cover for customer's use
- Positive mechanical keying for relay and socket

DESCRIPTION

The **RDT series** is a range of relays with electronic time delay on pick-up or on drop-out, consisting of 6 models with 4 changeover contacts, from 10 A (nominal). RDT relays are created by assembling electromechanical units of the RDM series with a **digital electronic circuit**. The electronic circuit is assembled using a small number of selected professional components for top reliability. The electronics are **immune to strong EMC interference**, typical of high voltage electricity distribution stations.

These monostable relays are capable of switching times ranging from **0.1 second to over 16 hours**, providing **extreme accuracy** over the entire setting range. This is made possible by the fact that the relay offers intermediate scales, which the user can select by means of rotary switches positioned on the front of the enclosure.

The contacts used are of a type designed to give good levels of performance both with high and strongly inductive d.c. loads, and with particularly low loads such as interface signals; inclusion of the magnetic arc blow-out function, when installed, helps to achieve a **considerable increase in breaking capacity**. Knurled contacts ensure not only better self-cleaning characteristics, but also lower ohmic resistance thanks to multiple points of electrical connection, thereby extending the electrical life expectancy of the component.

The timing function can be utilized in two modes: "on pick-up" or "on drop-out"; models are available with 4 timer contacts or with 2 timer contacts and 2 instantaneous contacts.

The construction of the relays and their simplified mechanical design combine to ensure these products offer **high reliability in operation**, as proven by their use for over **40 years in electrical energy transmission and distribution systems**, and fixed equipment used in the railway sector. Typical sectors of use are among the most demanding, such as, for example, electricity generating stations, electrical transformer stations, fixed equipment for railways, or industries using continuous production processes (chemical and petrochemical, rolling mills, cement factories, etc.).

Like all our relays, the models in the RDT series are assembled as part of a controlled manufacturing process in which every step of production is verified by the next step in succession. In effect, **each relay is calibrated and tested individually, by hand**, in such a way as to guarantee **top reliability**.

Models	Number of contacts		Magnetic arc blow-out	Separate control voltage	Function
	Instantaneous	Time-delayed			
RDT.x1c	-	4			Pick-up / Drop-out
RDT.x7c	-	4	•		Pick-up / Drop-out
RDT.x2c	2	2			Pick-up / Drop-out
RDT.x8c	2	2	•		Pick-up / Drop-out
RDT.x4c	-	4		•	Pick-up / Drop-out
RDT.x9c	-	4	•	•	Pick-up / Drop-out

FOR CONFIGURATION OF PRODUCT CODE, SEE "ORDERING SCHEME" TABLE

Coil specifications	RDT.x1c-x4c-x7c-x9c	RDT.x2c-x8c
Nominal voltages Un	AC / DC: 12-24-48-110-125-132-144-220 ⁽¹⁾	
Consumption at Un (DC/AC)	3.5W	4.5W
Operating range	80...120% Un	
Type of duty	Continuous	
Drop-out voltage ⁽²⁾	> 5% Un	

(1) Other values on request.

(2) Limit value for supply voltage, expressed as % of the nominal value, beneath which the relay is certain to be de-energized.

Contact specifications		4 CO, form C
Current	Nominal ⁽¹⁾	10A
	Maximum peak ⁽²⁾	13A for 1min - 20A for 1s
	Maximum pulse ⁽²⁾	100A for 10ms
Example of electrical life expectancy ⁽³⁾		RDT.x1c-x2c-x4c : 0.2A - 110Vdc - L/R = 40ms - 10 ⁵ operations - 1,800 operations/hour RDT.x7c-x8c-x9c : 0.5A - 110Vdc - L/R = 40ms - 10 ⁵ operations - 1,800 operations/hour
Minimum load	Standard contacts	200mW (10V, 10mA)
	Gold-plated contacts	50mW (5V, 5mA)
Maximum breaking voltage		250 Vdc / 300 Vac
Contact material		AgCdO (moving contacts) - AgNi (fixed contacts)
Operating time at Un (ms) ^{(4) (5)}		DC - AC
Pick-up (NC contact opening)		≤ 10 - ≤ 10
Pick-up (NO contact closing)		≤ 19 - ≤ 18
Drop-out (NO contact opening)		≤ 4 - ≤ 8
Drop-out (NC contact closing)		≤ 16 - ≤ 19

(1) On all contacts simultaneously, reduction of 30%.

(2) Maximum peak and pulse currents are those currents that can be handled, for a specified time, by the contact. They do not refer to steady or interrupted currents.

(3) For other examples, see electrical life expectancy curves.

(4) Unless specified otherwise, the operating time signifies until stabilization of the contact (including bounces).

(5) Times for instantaneous contacts, if installed.

Insulation		
Insulation resistance (at 500Vdc)	between electrically independent circuits and between these circuits and ground	> 10,000 MΩ
	between open contact parts	> 10,000 MΩ
Withstand voltage at industrial frequency	between electrically independent circuits and between these circuits and ground	2 kV (1 min) - 2.2 kV (1 s)
	between open contact parts	2 kV (1 min) - 2.2 kV (1 s)
	between adjacent contacts	2 kV (1 min) - 2.2 kV (1 s)
Impulse withstand voltage (1.2/50μs - 0.5J)	between electrically independent circuits and between these circuits and ground	5 kV
	between open contact parts	3 kV

Mechanical specifications		
Mechanical life expectancy	Mechanical	20x10 ⁶ operations
Maximum switching rate	Mechanical	3,600 operations/hour
Degree of protection		IP40
Dimensions (mm)		40x40x82 ⁽¹⁾
Weight (g)		150

(1) Excluding output terminals

MONOSTABLE INSTANTANEOUS
INSTANTANEOUS MONOSTABLE WITH FORCIBLY GUIDED CONTACTS
BISTABLE
FAST-ACTING MONOSTABLE (AND BISTABLE)
TIME DELAY (ON PICKUP OR DROP-OUT)
TIME DELAY WITH FORCIBLY GUIDED CONTACTS
MEASUREMENT
SOCKET NUMBERING EXPLANATIONS
FRONT CONNECTION
BACK CONNECTION
PCB MOUNT
RETAINING CLIPS



Environmental specifications

Operating temperature	-25 to +55°C
Storage and shipping temperature	-25 to +70°C
Relative humidity	Standard: 75% RH - Tropicalized: 95% RH
Fire behavior	V0



Standards and reference values

EN 61810-1, EN 61810-2, EN 61810-7 EN61812-1 EN 60695-2-10 EN 61000 EN 60529	Electromechanical elementary relays Timer relays Fire behavior Electromagnetic compatibility Degree of protection provided by enclosures
--	--

Unless otherwise specified, products are designed and manufactured according to the requirements of the European and International standards indicated above.
In accordance with EN 61810-1, all items of technical data are referred to ambient temperature 23 °C, atmospheric pressure 96kPa and 50% humidity.
Tolerance for coil resistance, nominal electrical input and nominal power is ±7%.



Configurations - Options

TROPICALIZATION	Surface treatment of coil with protective coating for use in conditions of RH 95%.
GOLD PLATING	Surface treatment of contacts, blades and output terminals with gold-cobalt alloy, thickness ≥2μ. This treatment guarantees the contact's ability to cut weaker currents over the long term.



Ordering scheme

Product code	Application ⁽¹⁾	Configuration A	Configuration B	Type of power supply	Nominal voltage(V) ⁽²⁾	Finish ⁽³⁾	Keying position code ⁽⁴⁾
RDT	E: Energy F: Railway Fixed Equipment	1: Standard 4: Gold plating	1C: 4 CO timer contacts 2C: 2 CO timer contacts + 2 CO instantaneous contacts 4C: 4 CO timer contacts with control voltage 7C: 4 CO timer contacts with magnetic arc blow-out 8C: 2 CO timer contacts + 2 CO instantaneous contact with magnetic arc blow-out 9C: 4 CO timer contacts with control voltage and magnetic arc blow-out	C: Vdc A: Vac 50 Hz H: Vac 60 Hz T ⁽⁵⁾ : Vdc + Vac 50 Hz	012 - 024 - 048 110 - 125 - 132 144 - 220	T: Tropicalized coil	xx

Example

RDT	E	1	7C	T	110	T	ZH
RDTE17C-T110/T-ZH = ENERGY series relay with 4 CO timer contacts, magnetic arc blow-out, 110Vdc or Vac (50Hz) tropicalized coil, and keying position ZH							
RDT	F	4	2C	C	024		XG
RDTE42c-C024 = RAILWAY series relay, fixed equipment, with 2 CO timer contacts and 2 instantaneous, gold-plated contacts, and 24Vdc coil							

(1) ENERGY: all applications except for railway.

RAILWAYS, FIXED EQUIPMENT: application on fixed power systems and electrical railway traction. For list of RFI compliant and type-approved products, consult dedicated catalog "RAILWAY SERIES - RFI APPROVED".

Also available is the STATIONS series, with ENEL approved material meeting LV15/LV16 specifications. For list of ENEL compliant and type-approved products, consult dedicated catalog "STATIONS SERIES - LV15-LV16-LV20".

(2) Other values on request.

(3) Optional value.

(4) Optional value. The positive mechanical keying is applied according to the manufacturer's model.

(5) AC+DC power input possible only with models RDT.x1C and RDT.x7C

Wiring diagram

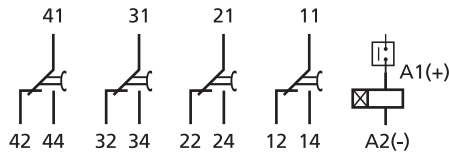

Pick-up diagram RDT.x1c-x7c

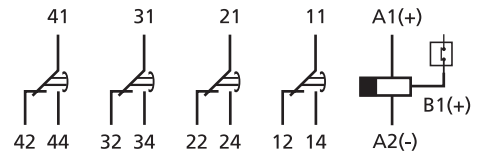

Drop-out diagram RDT.x1c-x7c

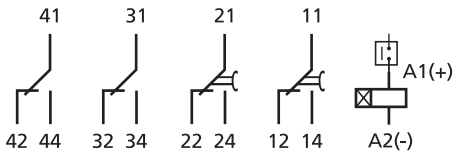

Pick-up diagram RDT.x2c-x8c

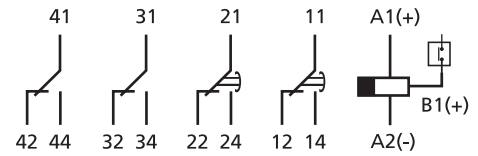

Drop-out diagram RDT.x2c-x8c

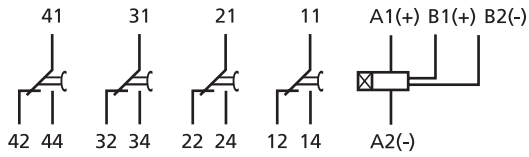

Pick-up diagram RDT.x4c-x9c

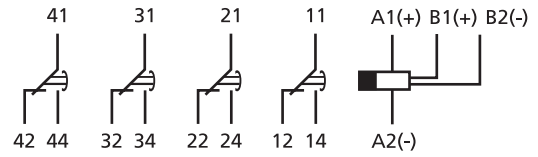

Drop-out diagram RDT.x4c-x9c

Functional diagram

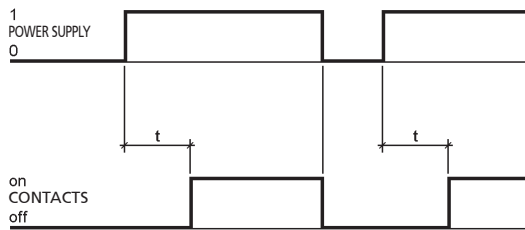

Pick-up delay RDT.x1c-x7c

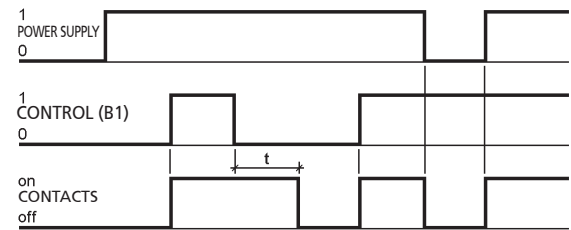

Drop-out delay RDT.x1c-x7c

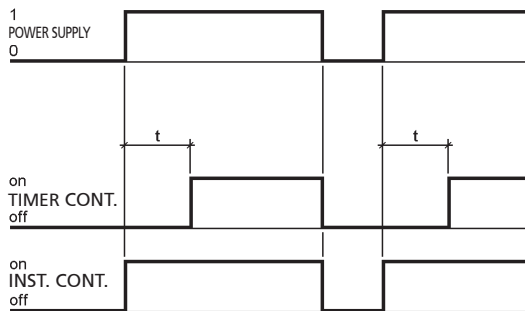

Pick-up delay RDT.x2c-x8c

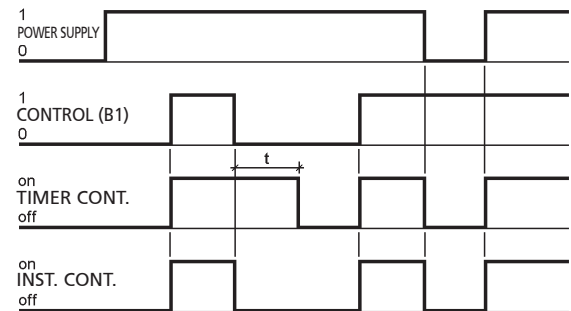

Drop-out delay RDT.x2c-x8c

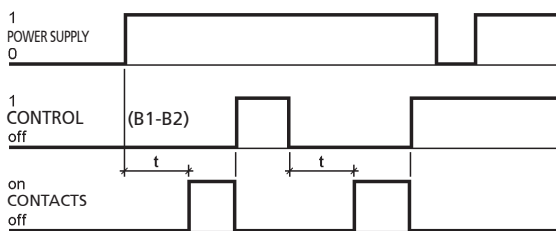

Pick-up delay RDT.x4c-x9c Drop-out

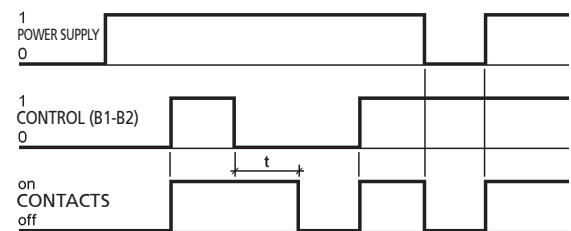

Drop-out delay RDT.x4c-x9c



Time delay - Switching time setting

Time setting	By means of DIP switches and selectors
Time setting range	100 ms...990 min
Intermediate scales	6 (0.99 - 9.9 - 99 - 990 secondes / 99 - 990 minutes)
Resolution of switching time setting	1/100 of selected scale
Operating accuracy (0.8...1.1 Un, t=20°C) ⁽¹⁾	± 3 % at low end of scale - ±0.5 % at high end of scale
Accuracy, repeatability	± 2 %
Reset	< 200 ms
Insensitivity to voltage drops	< 100 ms
Indication	Red led = presence of power supply Green led = status of relay outputs (lights up with relay energized)

(1) Additional error for drop-out versions: 100 ms

The timer function and the switching time are set by way of a single 4-bit DIP switch and two rotary selectors adjustable through 10 positions, located on the front of the relay (see "FRONT"). These are accessible by opening the flap on the cover of the relay. The time delay function can be associated either with pick-up or with drop-out; settings range from 100 ms up to 990 minutes.

Selection of function: select the OFF or ON position at switch no. 4. OFF: Pick-up - ON: Drop-out.

Selection of operating time: the unit of measure is selected with switches no. 1-2-3, and the desired delay interval by means of the 2 rotary selectors.

To set the switching time correctly, the first step required is to identify and select one of the 6 intermediate scales indicated in table 1. The intermediate scale should be the next higher numerically than the value of the required switching time.

E.g. Switching time: 1'14" (74 seconds), Intermediate scale setting: 99 seconds.

This done, proceed to set the desired value with the two rotary selectors. E.g. 74 seconds, select 7 on the "TENS" selector and 4 on the "UNITS" selector.

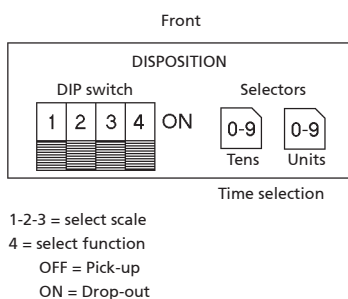

Scales / Setting range			Switch position		
Min	Max	Unit of measure	1	2	3
1	99	Hundredths (0.01s)	OFF	ON	OFF
1	99	Tenths (0.1s)	OFF	ON	ON
1	99	Seconds	ON	OFF	OFF
1	99	Seconds x 10	ON	OFF	ON
1	99	Minutes	ON	ON	OFF
1	99	Minutes x 10	ON	ON	ON

Table 1

Dimensions

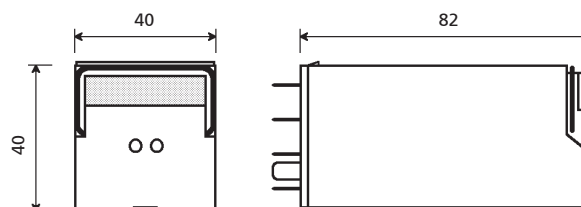

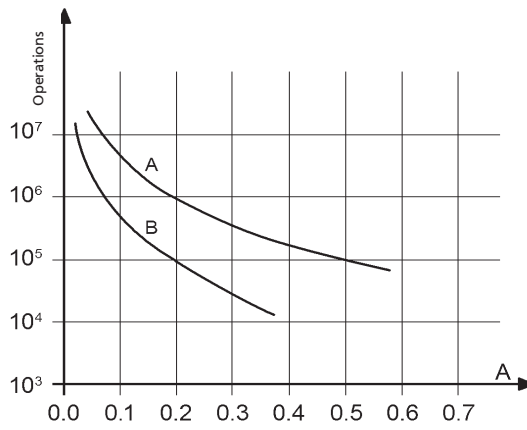

Contact loading: 110Vdc, L/R 40 ms
 Curve A: RDT_x7-x8-x9
 Curve B: RDT_x1-x2-x4

RDT_x1-x2-x4			
U	I (A)	L/R (ms)	Operations
110 Vdc	0.2	40	500,000
220 Vdc	0.2	10	80,000
U	I (A)	cosφ	Operations
110 Vac	1	1	1,200,000
110 Vac	1	0.5	1,000,000
110 Vac	5	1	500,000
110 Vac	5	0.5	300,000
220 Vac	0.5	1	1,200,000
220 Vac	1	0.5	500,000
220 Vac	5	1	400,000
220 Vac	5	0.5	300,000

Switching frequency: 1,200 operations/hour
 (*) 600 operations/hour

RDT_x7-x8-x9			
U	I (A)	L/R (ms)	Operations
110 Vdc	0.2	40	1,000,000
110 Vdc	0.5	40	150,000
110 Vdc	0.6	10	300,000
110 Vdc	1	10	100,000 (*)
220 Vdc	0.2	10	100,000
U	I (A)	cosφ	Operations
110 Vac	1	1	2,000,000
110 Vac	1	0.5	1,500,000
110 Vac	5	1	950,000
110 Vac	5	0.5	500,000
220 Vac	0.5	1	2,000,000
220 Vac	1	0.5	800,000
220 Vac	5	1	600,000
220 Vac	5	0.5	500,000

Switching frequency: 1,200 operations/hour

Sockets and retaining clips

Type of installation	Type of outputs	Model	Retaining clip
Wall or DIN H35 rail mounting	Screw	PAVD161	VM1823
Flush mounting	Screw	PRVD161	-
PCB-mount	Solder	PRCD161	-

Mounting tips

The preferred mounting position is on the wall, with the relay positioned horizontally in the reading direction on the nameplate. For correct use of the relays, they should be spaced apart by at least 5 mm in the horizontal direction and 20 mm in the vertical direction. This is to allow correct upward dissipation of the heat generated by the coil. Set these distances according to the socket used. Distances can be reduced depending on the environmental application conditions and on the relay duty cycle. No special maintenance is required. Condensation can form inside the relay when powered up and the outside ambient temperature is cold; this is quite normal and does not affect the operation of the relay. The plastic materials of the relay do not possess hygroscopic properties.



RELAYS

RELAY WITH TIME DELAY ON DROP-OUT, CAPACITOR TYPE

RDTE15-16 | RGTO SERIES

USER SECTORS



Power generation



Nuclear



Power transmission



Rolling stock



Fixed railway installations



Shipbuilding



Shipbuilding



Heavy industry



RDTE161



RGTO233

PRODUCT ADVANTAGES

- Plug-in relay with time delay on drop-out
- Time settings up to 60s, no auxiliary power supply required
- Self-cleaning knurled contacts
- High performance, compact dimensions
- Solid and rugged construction for heavy or intensive duty
- Very long electrical life expectancy and exceptional endurance
- Wide variety of configurations and customizations
- Retaining clip for secure locking of relay on socket
- Transparent cover, pull-out handle
- Positive mechanical keying for relay and socket

DESCRIPTION

The timer relays in the **RDT.15 / RDT.16** and **RGTO** series are delay-on-drop-out devices using a capacitor wired in parallel with the coil. They require no auxiliary power supply during the timing step. The delay can be fixed (RDT.15), or adjustable (RDT.16, RGTO), from 0.1s to 60s. The delay capacitor is fitted internally on all versions.

The construction of the relays and their simplified mechanical design combine to ensure these **products offer high reliability** in operation, as proven by their use for over **40 years in electrical energy transmission and distribution systems**, and fixed equipment used in the railway sector.

The contacts used for relays of the RDT.15 and RDT.16 series are of a type able to **give good levels of performance** both with high and strongly inductive d.c. loads, and with particularly low loads such as interface signals.

Knurled contacts ensure not only better self-cleaning characteristics, but also lower ohmic resistance thanks to multiple points of electrical connection, thereby extending the electrical life expectancy of the component.

Typical sectors of use are among **the most demanding**, such as, for example, electricity generating stations, electrical transformer stations, fixed equipment for railways, or industries using continuous production processes (chemical and petrochemical, rolling mills, cement factories, etc.).

Like all our relays, the models in the RDT.15-16 and RGTO series are assembled as part of a controlled manufacturing **process in which every step of production is verified** by the next step in succession. In effect, **each relay is calibrated and tested individually, by hand**, in such a way as to guarantee **top reliability**.

Models	Number of timed contacts	Nominal current	Time delay	Time settings range
RDT.15x	4	10 A	On drop-out, fixed	0.1...1 s
RDT.161	4	10 A	On drop-out, adjustable	0.1...6 s
RGTO23x	1	5 A	On drop-out, adjustable	3...60 s

FOR CONFIGURATION OF PRODUCT CODE, SEE "ORDERING SCHEME" TABLE

Coil specifications	RDT.15x	RDT.161	RGTO23x
Nominal voltages Un ⁽¹⁾	DC: 24-48-110-125-220	DC: 24-48-110-125-220	AC: 24-48-110-125-220
Consumption at Un (DC/AC)	3.5 W		1.5 W
Operating range	DC: 80...120 % Un AC: 85...110 % Un		
Type of duty	Continuous		
Drop-out voltage ⁽²⁾	DC: > 5 % Un AC : > 15 % Un		

(1) Other values on request.

(2) Limit value for supply voltage, expressed as % of the nominal value, beneath which the relay is certain to be de-energized.

Contact specifications	RDT.15x, RDT.161	RGTO23x
Number and type	4 CO, form C	2 CO, form C
Current	10A	5 A
Nominal ⁽¹⁾		-
Maximum peak ⁽²⁾	13A for 1min - 20A for 1s	-
Maximum pulse ⁽²⁾	100A for 10ms	-
Example of electrical life expectancy ⁽³⁾	0.2 A - 110 Vdc - L/R 40 ms - 10 ⁵ operations - 1,800 operations/hour	0.2 A - 110 Vdc - L/R 40 ms - 10 ⁵ operations - 1,200 operations/hour
Minimum load	200 mW (10 V, 10 mA)	
Maximum breaking voltage	250 Vdc / 300 Vac	

(1) Maximum peak and pulse currents are those currents that can be handled, for a specified time, by the contact. They do not refer to steady or interrupted currents.

(2) For other examples, see electrical life expectancy curves.

Insulation	RDT.15x - RDT.161	RGTO23x
Insulation resistance (at 500Vdc)		
between electrically independent circuits and between these circuits and ground	> 10,000 MΩ	> 10,000 MΩ
between open contact parts	> 10,000 MΩ	> 10,000 MΩ
Withstand voltage at industrial frequency		
between electrically independent circuits and between these circuits and ground	2 kV (1 min) - 2.2 kV (1 s)	2 kV (1 min) - 2.2 kV (1 s)
between open contact parts	2 kV (1 min) - 2.2 kV (1 s)	1 kV (1 min) - 1.1 kV (1 s)
between adjacent contacts	2 kV (1 min) - 2.2 kV (1 s)	
Impulse withstand voltage (1.2/50μs - 0.5J)		
between electrically independent circuits and between these circuits and ground	5 kV	2.5 kV
between open contact parts	2.5 kV	2 kV

Mechanical specifications	RDT.15x	RDT.161	RGTO23x
Mechanical life expectancy	20x10 ⁶ operations		
Maximum switching rate	3,600 operations/hour		
Degree of protection	IP40		
Dimensions (mm)	40x40x75 ⁽¹⁾	40x40x82 ⁽¹⁾	50x45x112 ⁽¹⁾
Weight (g)	130	130	260

(1) Excluding output terminals

Environmental specifications	
Operating temperature	-25 to 55°C
Storage and shipping temperature	-25 to 70°C
Relative humidity	Standard: 75% RH - Tropicalized: 95% RH
Fire behavior	V0



Standards and reference values

EN 61810-1, EN 61810-2, EN 61810-7
 EN 60695-2-10
 EN 61000
 EN 60529

Electromechanical elementary relays
 Fire behavior
 Electromagnetic compatibility
 Degree of protection provided by enclosures

Unless otherwise specified, products are designed and manufactured according to the requirements of the European and International standards indicated above.
 In accordance with EN 61810-1, all items of technical data are referred to ambient temperature 23 °C, atmospheric pressure 96kPa and 50% humidity.
 Tolerance for coil resistance, nominal electrical input and nominal power is $\pm 7\%$.



Configurations - Options

TROPICALIZATION Surface treatment of the coil with protective coating for use with RH 95%.



Ordering scheme

Product code	Application ⁽¹⁾	Configuration A	Configuration B	Label	Type of power supply	Type of input supply (V) ⁽²⁾	Finish ⁽³⁾	Keying position code ⁽⁴⁾
RDT	E: Energy	15: Fixed duration	1: Fixed duration 0.1s	F	C: Vdc	024 - 048 - 110 125 - 220	T: Tropicalized coil	xx
	F: Railway Fixed Equipment		2: Fixed duration 0.2s					
		16: Adjustable duration	3: Fixed duration 0.5s					
			4: Fixed duration 1s					
RGTO	-	23: Adjustable duration	1: Adjustable from 0.1 to 6s		A: Vac 50 Hz			
			3: Adjustable from 3 to 10s		H: Vac 60 Hz			
			4: Adjustable from 10 to 30s					
			5: Adjustable from 20 to 60s					

Example	RDT	E	16	1	F	C	110	T		
	RDTE161F-C110/T = ENERGY series relay, with 4 CO contacts, time delay on drop-out adjustable from 0.1 to 6s, and 110Vdc tropicalized coil.									
	RGTO		23	3	F	C	024			
	RGTO233F-C024 = Relay with 2 contacts: 1 CO instantaneous, 1 CO time delay on drop-out adjustable from 3 to 10 seconds, and 24Vdc coil.									

(1) ENERGY: all applications except for railway.

RAILWAYS, FIXED EQUIPMENT: application on fixed power systems and electrical railway traction. For list of RFI approved and conforming products, consult dedicated catalogue "RAILWAY SERIES – RFI APPROVED".

Also available is the STATIONS series, with ENEL approved material meeting LV15/LV16 specifications. For list of ENEL compliant and type-approved products, consult dedicated catalogue "STATIONS SERIES – LV15-LV16-LV20". (2) Other values on request.

(3) Optional value.

(4) Optional value. Positive mechanical keying is applied according to the manufacturer's model.

Wiring diagram

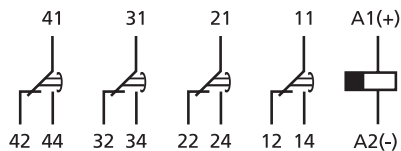

RDT.15x, RDT.161

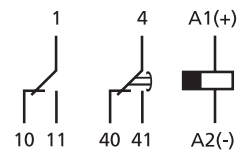

RGTO23x



Time delay – Switching time setting

	RDT.15x	RDT.161	RGTO23x		
Time setting	Fixed duration	By way of potentiometer, with slotted head screw	By way of potentiometer		
Full scale times available 0.1s -	0.1 s - 0.2 s - 0.5 s - 1 s	6 s	10 s	30 s	60 s
Time setting range	-	0.1 - 6 s ⁽¹⁾	3...10 s	10...30 s	30...60 s
Operating accuracy (0,8...1,1 Un, t=20 °C)		$\pm 10\%$ at high end of scale			
Accuracy, repeatability		$\pm 2\%$			
Reset		<200ms			

(1) The setting controls are accessible by opening the flap on the cover of the relay.

Dimensions

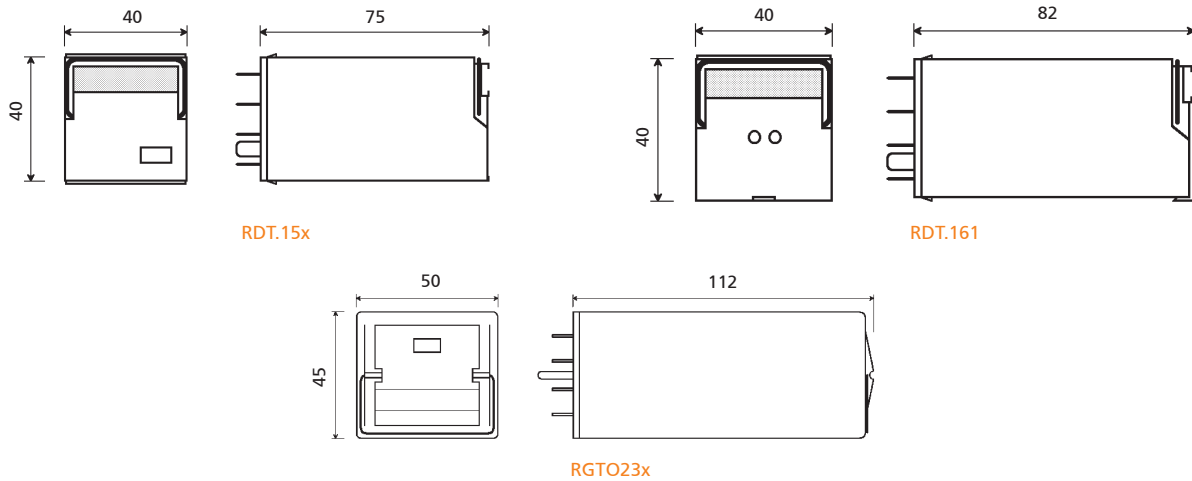

Electrical life expectancy

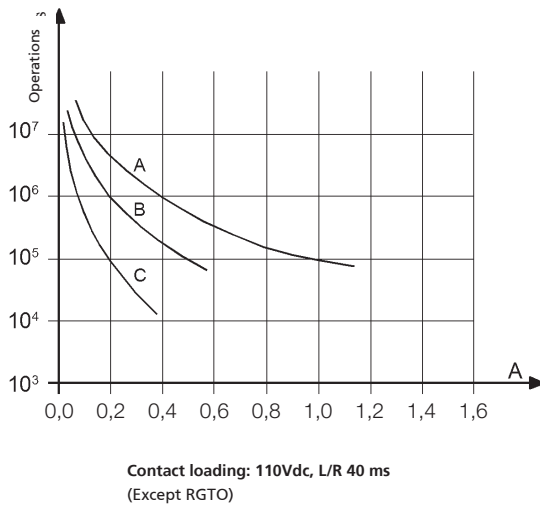

RDT_15x, RDT_161			
U	I (A)	L/R (ms)	Operations
110 Vdc	0.2	40	1,000,000
110 Vdc	0.5	40	150,000
110 Vdc	1	10	100,000 (*)
220 Vdc	0.2	10	100,000
U	I (A)	cosφ	Operations
110 Vac	1	1	2,000,000
110 Vac	1	0.5	1,500,000
110 Vac	5	1	950,000
110 Vac	5	0.5	500,000
220 Vac	0.5	1	2,000,000
220 Vac	1	0,5	800,000
220 Vac	5	1	600,000
220 Vac	5	0.5	500,000
220 Vac	0.5	1	2,000,000
220 Vac	5	1	500,000

Switching frequency: 1,200 operations/hour
(*) 600 operations/hour

Sockets and retaining clips

Sockets and retaining clips		RDTE15x, RDTE161			RGTO23x	
Type of installation	Type of outputs	Socket	Clip for RDTE15x	Clip for RDTE161x	Socket	Clip
Wall or DIN H35 rail mounting	Screw	PAVD161	VM1822	VM1823	PAVG161	VM1222
Flush mounting	Double faston (4.8 x 0.8 mm)	-	-	-	PRDG161	VM1222
	Screw	PRVD161	-	-	PRVG161	VM1222
PCB-mount	Solder	PRCD161	-	-	-	-

Mounting tips

The preferred mounting position is on the wall, with the relay positioned horizontally in the reading direction on the nameplate. For correct use of the relays, they should be spaced apart by at least 5 mm in the horizontal direction and 20 mm in the vertical direction. This is to allow correct upward dissipation of the heat generated by the coil. Set these distances according to the socket used. Distances can be reduced depending on the environmental conditions during operation, and on the relay duty cycle. No special maintenance is required.

Condensation can form inside the relay when powered up and the outside ambient temperature is cold; this is quite normal and does not affect the operation of the relay. The plastic materials of the relay do not possess hygroscopic properties.



RELAYS

MULTIFUNCTION MULTISCALE TIMER DELAY WITH 4 CONTACTS

TMM SERIES

USER SECTORS



Power generation



Nuclear



Power transmission



Rolling Stock



Fixed railway installations



Shipbuilding



Petroleum industry



Heavy industry



TMM

PRODUCT ADVANTAGES

- Plug-in relay with time delay, multifunction
- 10 different time delay functions
- 4 time delay contacts or 2 time delay contacts + 2 instantaneous contacts
- Wide time setting range from 0.1s to 99 hours, extreme accuracy across the adjustment range
- High electromagnetic interference immunity
- Solid and rugged construction for heavy or intensive duty
- Long life expectancy
- Independent and self-cleaning contacts
- Magnetic arc blow-out standard
- Separate arc breaking chambers
- Excellent shock and vibration resistance
- Wide range of sockets
- Wide variety of configurations and customizations
- Retaining clip for secure locking of relay on socket
- Transparent cover, pull-out handle
- Positive mechanical keying for relay and socket

DESCRIPTION

The **TMM series** is a range of multifunction relays with electronic time delay, consisting of 2 models with 4 change-over contacts, rated 10 A (nominal). They are obtained by assembling the electromechanical units of the POKS series with a digital electronic circuit. The electromechanical part features the **reliability and ruggedness of relays belonging to the POKS series**, while the electronics offers high reliability thanks to the use of a circuit requiring few components and to the careful choice of professional products.

A single TMM series relay offers **10 different timer functions, freely programmable** by the user; these include, by way of example, time delay on pick-up or on drop-out, flasher, one-shot, etc.

The switching time can be selected within a wide range extending from 0.1 second to 99 hours, with **extreme accuracy** guaranteed across the full scale of adjustment. This is made possible by providing the relay with **10 intermediate scales**.

The timer function, the scale and the switching time are adjustable by means of 4 rotary switches, each having 10 positions, located on the front of the relay.

The electronic circuit is immune to high electromagnetic interference, typical of high voltage electricity distribution stations. The construction of the relays and careful choice of the materials are such that they ensure long life and considerable ruggedness even in harsh operating environments and in the presence of strong temperature fluctuations.

Excellent electrical and mechanical performance levels allow the product to be used in the most demanding of sectors such as, for example, rail transport, control and signalling functions in electricity generating stations, electrical transformer stations, or in industries with continuous production processes (chemical and petroleum industries, rolling mills, cement factories, etc.). Above all, the excellent ability to withstand shock and vibration allow their use on rolling stock.

Models	Nominal current	Number of contacts		Rolling stock application
		Time-delayed	Instantaneous	
TMM2	10 A	2	2	•
TMM4	10 A	4	-	•

FOR CONFIGURATION OF PRODUCT CODE, SEE "ORDERING SCHEME" TABLE

Coil specifications

Nominal voltages Un ⁽¹⁾	DC: 12-24-36-48-72-110-125-132-144-220 AC: 12-24-48-110-127-220-230
Max. consumption at Un (DC/AC)	TMM2: 5.5 W / 7.5 VA TMM4: 4.5 W / 6.5 VA
Operating range ⁽¹⁾	80 ÷ 115 % Un
Rolling stock version ^{(2) (3)}	DC: 70 ÷ 125 % Un
Type of duty	Continuous
Drop-out voltage ⁽⁴⁾	> 15% Un

- (1) Other values on request.
(2) See "Ordering scheme" table for order code.
(3) For operating ranges different to that specified by EN60077, refer to table "Rolling stock versions - Special Ranges".
(4) Limit value for supply voltage, expressed as % of the nominal value, beneath which the relay is certainly de-energized.

Contact specifications

	TMM2	TMM4
Number and type	2 timed + 2 instantaneous CO, form C	4 timed, CO, form C
Current	10 A	
Nominal ⁽¹⁾	20 A (1 min) / 40 A (500 ms)	
Maximum peak (1 s) ⁽²⁾	150 A	
Maximum pulse (10 ms) ⁽²⁾	0.7 A – 132 Vdc – L/R 40 ms: 10 ⁵ operations	
Example of electrical life expectancy ⁽³⁾	1 A – 110 Vdc – L/R 0 ms: 10 ⁵ operations	
1 800 operations/h	30 A (for 200 ms) – 110 Vdc – L/R 0 ms: 2,000 operations	
Making capacity	500 mW (20 V, 20 mA)	
Minimum load	100 mW (10 V, 5 mA)	
Standard contacts	50 mW (5 V, 5 mA)	
Gold-plated contact P4GEO ⁽⁴⁾	250 Vdc / 350 Vac	
Gold-plated contact P8 ⁽⁴⁾	AgCu	
Maximum breaking voltage	DC ⁽⁷⁾ – AC	
Contact material	≤ 20 - ≤ 20	
Operating time at Un (ms) ^{(5) (6)}	≤ 15 - ≤ 20	
Pick-up (NO contact closing)		
Drop-out (NC contact closing)		

- (1) On all contacts simultaneously, reduction of 30%.
(2) The max. peak and pulse currents are those currents that can be handled, for a specified time, by the contact. They do not refer to steady or interrupted currents.
(3) For other values, see electrical life expectancy curves.
(4) Specifications of contacts on new relay
a) Plating material: P4 GEO: gold-nickel alloy (>6µ) P8: gold-cobalt alloy (>5µ), knurled contact
b) When the gold-plated contact is subject to heavy loads, it will be degraded on the surface. In such case, the characteristics of the standard contact should be taken into consideration. This does not impair relay operation.
(5) Times for the instantaneous component of the relay (TMM2 model).
(6) Unless specified otherwise, the operating time signifies until stabilization of the contact (including bounces). They should be added to the preset delay time.
(7) Addition of a flyback diode connected in parallel with the coil (DC version only) causes an increase in operating time when the relay drops out.

Insulation

Insulation resistance (at 500Vdc)	> 1,000 MΩ
between electrically independent circuits and between these circuits and ground	> 1,000 MΩ
between open contact parts	
Withstand voltage at industrial frequency	2 kV (1 min) - 2.2 kV (1 s)
between electrically independent circuits and between these circuits and ground	1 kV (1 min) - 1.1 kV (1 s)
between open contact parts	2,5 kV (1 min) - 3 kV (1 s)
between adjacent contacts	
Impulse withstand voltage (1.2/50µs - 0.5J)	5 kV
between electrically independent circuits and between these circuits and ground	3 kV
between open contact parts	



Mechanical specifications

Mechanical life expectancy		10 x 10 ⁶
Maximum switching rate	Mechanical	3,600 operations / h
Degree of protection (with relay mounted)		IP40
Dimensions (mm) ⁽¹⁾		40 x 50 x 97
Weight (g)		~ 220

(1) Excluding output terminals



Environmental specifications

Operating temperature	Standard	-25 ÷ + 55 °C
	Rolling stock version	-25 ÷ + 70 °C
Storage and shipping temperature		-40 ÷ + 70 °C
Relative humidity		Standard: 75% RH, Tropicalized: 95% RH
Resistance to vibrations		5 g - 10 ÷ 55 Hz - 1 min
Resistance to shock		20 g - 11 ms
Fire behavior		V0



Standards and reference values

EN 61810-1, EN 61810-2, EN 61810-7 EN 61812-1 EN 60695-2-10 EN 50082, EN 61000-4 EN 60529	Electromechanical elementary relays Timer relays Fire behavior Electromagnetic compatibility Degree of protection provided by enclosures
---	--

Unless otherwise specified, the products are designed and manufactured according to the requirements of the above-mentioned European and International standards. In accordance with EN 61810-1, all technical data are referred to ambient temperature of 23°C, atmospheric pressure of 96kPa and 50% humidity. Tolerance for coil resistance, nominal electrical input and nominal power is ±7%.



Railways, rolling stock - Standards

EN 60077 EN 50155 EN 61373 EN 45545-2 ASTM E162, E662	Electric equipment for rolling stock - General service conditions and general rules Electronic equipment used on rolling stock Shock and vibration tests, Cat 1 Class B Fire behavior, Cat E10, Requirement R26, V0 Fire behavior
---	---



Railways, rolling stock – Special operating ranges⁽¹⁾

Nominal voltage	Minimum pick-up voltage	Maximum operating voltage	Order symbol ⁽¹⁾
24 Vdc	16.8	32	Z01
72 Vdc	55	104	Z01
110 Vdc	77	144	Z01

(1) To request the special range, indicate the "Z0x" symbol in the "Keying position" field in the "Ordering scheme" table. The special range may be subject to operating specifications different from standard specifications. Please contact us for further information.



Configurations - Options

P2	Tropicalization of coil with epoxy resin for exposure to 95% RH (@ T 50 °C). This treatment also protects the coil against corrosion which could occur by combination of the humidity with certain chemical agents, such as those found in acidic or saline atmospheres.
P4GEO	Gold plating of contacts with gold-nickel alloy, thickness ≥ 6µ. This treatment ensures long-term capacity of the contact to conduct lower currents in harsh ambient conditions such as acid atmospheres (typical of geothermal power stations) or saline atmospheres.
P5GEO	Gold-plating of contacts P4GEO + tropicalization of coil P2 .
P6GEO	P4GEO type gold-plating, but applied to contacts, contact terminals and output terminals + P2 coil tropicalization.
P7	AgCdO (silver cadmium oxide) contacts.
P8	Gold plating of contacts with gold-cobalt alloy, thickness ≥ 5µ, knurled fixed contact. This finish allows further improvement of the gold-plated contact performance compared to the treatment P4GEO.
FLYBACK DIODE	Polarized component connected in parallel with the coil (type 1N4007 or BYW56 for rolling stock version) designed to suppress overvoltages generated by the coil when de-energized.
TRANSIL	Non-polarized component connected in parallel with the coil. Behavior is similar to that of a varistor, with faster operating times.



Ordering scheme

Product code	Application ⁽¹⁾	Configuration A	Configuration B	Label	Type of power supply	Nominal voltage (V) ⁽²⁾	Keying position ⁽³⁾
TMM2	E: Energy Railway Fixed Equipment	1: Standard 2: Diode //	0: Standard 2: P2 4: P4 GEO 5: P5 GEO 6: P6 GEO	F	C: Vdc A: Vac 50 Hz	012 - 024 - 036 048 - 072 - 100 110 - 125 - 127 132 - 144 - 220 230	XXX
TMM4	R: Railway Rolling Stock	3: Varistor 7: Transil	7: P7 8: P8				

Example

TMM2	E	1	8	F	C	024	
TMM2E18F-C024 - TMM2 relay, ENERGY series, nominal voltage 24 Vdc, with P8 finish (gold-plated contacts)							
TMM4	R	1	0	F	C	110	
TMM4R10F-C110 - TMM4 relay, ROLLING STOCK series, nominal voltage 110 Vdc							

(1) **E = ENERGY:** all applications, except for railways rolling stock.

Suitable on energy production, transport and distribution plants, railways fixed equipment, petrolchemical and heavy industry.

R = RAILWAYS, ROLLING STOCK: Application on board rolling stock (rail-tram-trolley vehicles). Electrical characteristics according to EN60077.

Availables also the product series:

RAILWAYS, FIXED EQUIPMENT: Approved and conforming relays and products to RFI (FS Group) specification no. RFI DPRIM STF IFS TE 143 A

For the list of RFI approved and conforming products, consult dedicated catalog "RAILWAY SERIES – RFI APPROVED".

STATIONS: ENEL approved material meeting LV15/LV16 specifications.

For the list of ENEL approved and conforming products, consult the dedicated catalog "STATIONS SERIES – LV15-LV16-LV20".

(2) Other values on request.

(3) Optional value. The positive mechanical keying is applied according to the manufacturer's model.

Dimensions and indicators

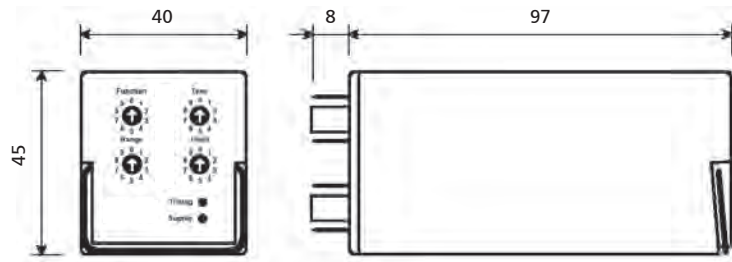

Timing = Green Led: time delay activated
Supply = Red Led: auxiliary power on

Wiring diagram

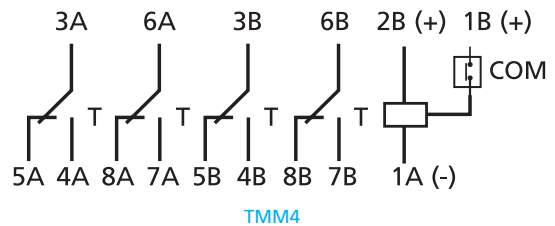
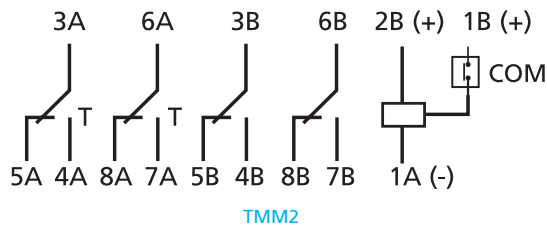

T= time delay contacts

Terminals 2B and 1A are allocated to the auxiliary power supply.

Terminal 1B is allocated to CONTROL. The negative of the control circuit is common with that of the auxiliary power supply.

Certain functions require an auxiliary power supply to guarantee operation of the time delay (terminal 2B).



Time delay – Switching time setting

Controls setting function, range and time	4 rotary switches with 10 positions (0...9)
Time setting range	100 ms...99 h
Intermediate scales	10, from 9.9 seconds to 99 hours
Resolution of switching time setting	1% of intermediate scale
Accuracy, time delay (0.8...1.1 Un, t=20°C)	DC: ± 1% of selected time or ± 10 ms ⁽¹⁾ AC: ± 1% of selected time; 0,1s...10s: ± 2% ± 20ms
Accuracy, repeatability	DC: ± 0.5 % AC: ± 0.5 % + 20 ms
Reset	< 200 ms during time delay interval < 400ms
"COM" control signal	> 10 mS

(1) Whichever of the two values is higher.

The function and switching time are adjustable by means of 4 rotary-switch selectors located on the front of the relay, each having 10 positions, with which the user can select time delay settings between 100 ms and 99 hours.

The position of the arrow point on each rotary switch indicates the number selected. Adjustments are made by discrete steps, which means that no intermediate settings are possible.

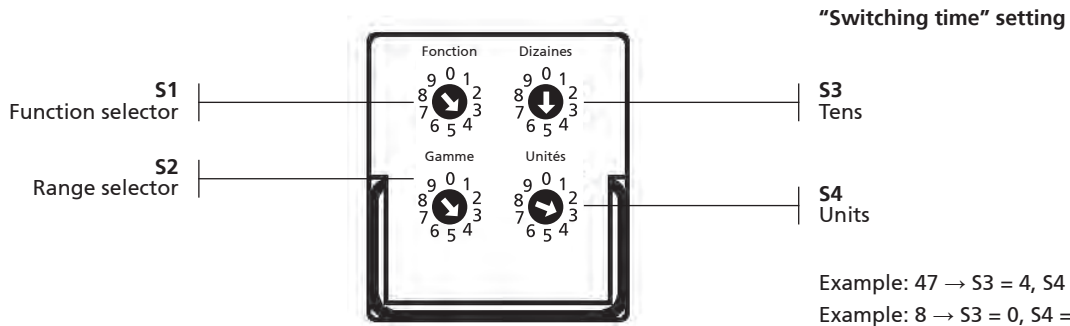

Adjustment of switching time (except for function F6)

To adjust the switching time, the first step is to adjust the intermediate scale T(s), by selecting one of the 10 available scales using the S2 rotary switch. The values available are given in table 1.

Scale	Minimum value	Maximum value	Step
0	0.1 s	9.9 s	100 ms
1	1 s	99 s	1 s
2	3 s	297 s	3 s
3	5 s	495 s	5 s
4	10 s	990 s	10 s
5	1 min	99 min	1 min
6	3 min	297 min	3 min
7	5 min	495 min	5 min
8	10 min	990 min	10 min
9	1 h	99 h	1 h

Table 1 – Available scales

Next, the switching time is adjusted by means of rotary-switch selectors S3 and S4.

The combination of these two 10-position controls, located on the right, allows the selection of a number between 1 and 99. The number selected with the "Tens" arrow combined with the number selected with the "Units" arrow represents the multiplier of the step selected via the "Range" control. The resulting value gives the time used by the relay in operation.

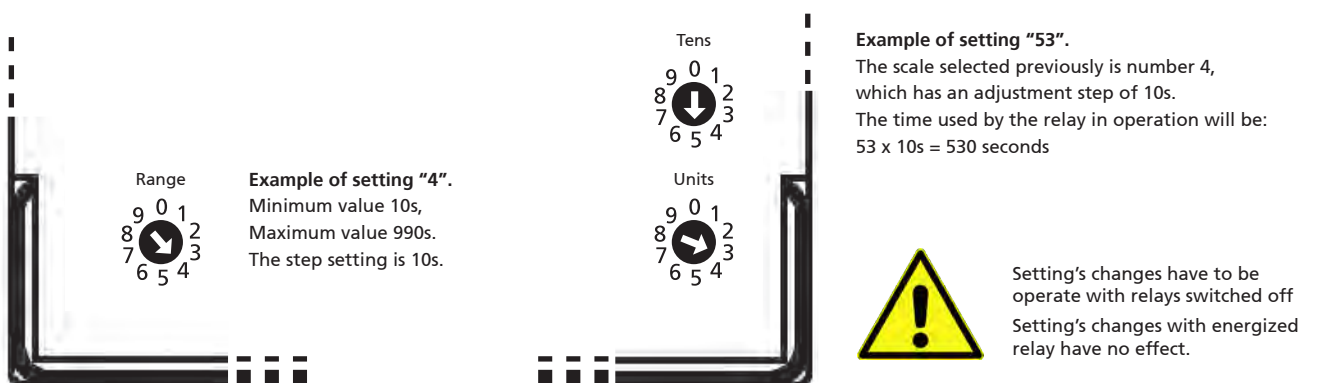

Adjustment of switching time for function F5 – Asymmetric flash

Function F5 pilots an asymmetric flash. The "ON" time and the "OFF" time are adjustable independently

"ON" time (t) → selector S4

"OFF" time (T) → selector S3

In this instance, selector S3 and selector S4 are both calibrated in UNITS. Position "0" assumes the value of 10 integers.

Once the scale has been set by means of selector S2, selectors S3 and S4 are used to set the number that will provide the multiplier for the step of the selected scale.

Example: S2 = 1 → unit of time : seconds

S4 = 3 → t = 3 seconds

S3 = 0 → T = 10 seconds

Functions - selections and operating diagrams

SELECTING THE FUNCTION

The function is selected by positioning the arrow of selector S1 so that the point is aligned with the number of the required function.

Function	Description
F0	Time delay on pick-up.
F1	Time delay on drop-out. Instantaneous contacts follow the status of the auxiliary power supply.
F2	Time delay on drop-out, instantaneous contacts on "CONTROL". Instantaneous contacts follow the status of the control signal.
F3	One-shot function.
F4	Flasher, symmetrical. The "ON" time and the "OFF" time are the same.
F5	Flasher, asymmetrical. The "ON" time and the "OFF" time are different, and adjustable independently.
F6	One-shot function on "CONTROL". The timing cycle starts on activation of the control signal.
F7	One-shot function with fixed pulse (3s), delayed at pick-up. Pulse delay adjustable.
F8	One-shot function, on "CONTROL", with fixed pulse (3s), delayed at pick-up. The timing cycle starts on activation of the control signal. Pulse delay adjustable.
F9	Step function

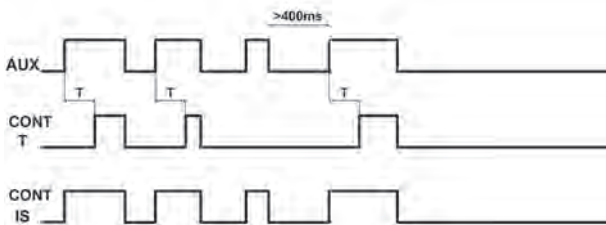

F0 – Time delay on pick-up.

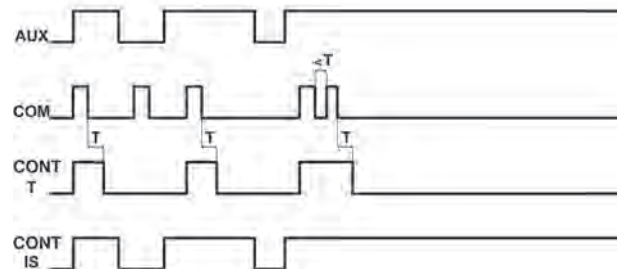

F1 – Time delay on drop-out, instantaneous contacts follow the status of the auxiliary power supply.

The instantaneous contacts follow the status of the auxiliary power supply (2B terminal).

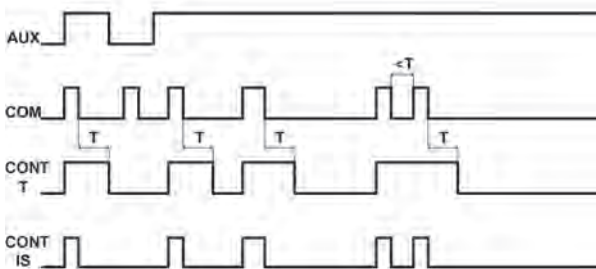

F2 – Time delay on drop-out.

The instantaneous contacts follow the status of the control signal ("COM", 1B terminal).

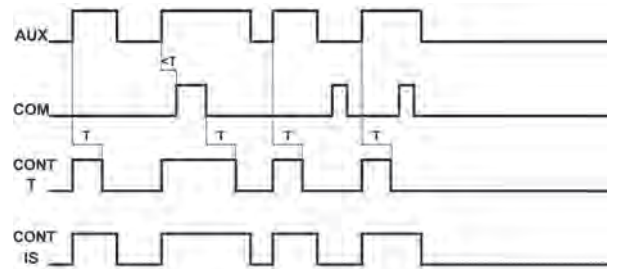

F3 – One-shot function.

The control signal ("COM", 1B terminal) resets the time "t", on drop-out.

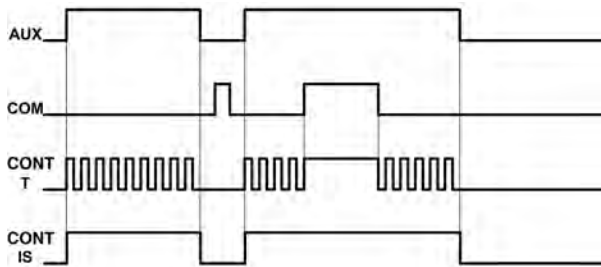

F4 – Flasher, symmetrical.

The control signal ("COM", 1B terminal) stops the flash.

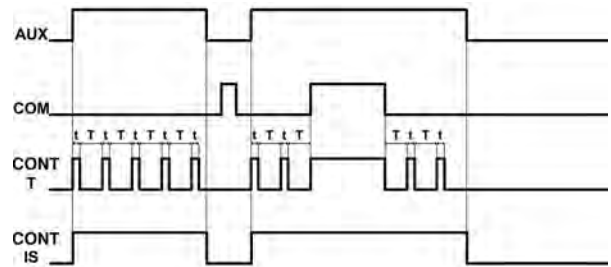

F5 – Flasher, asymmetrical.

The control signal ("COM", 1B terminal) stops the flash t and T are adjustable using the same unit of time.
 Example: S2 = 1φ unit of time: seconds
 S4 = 3φ t = 3 seconds
 S3 = 0φ T = 10 seconds

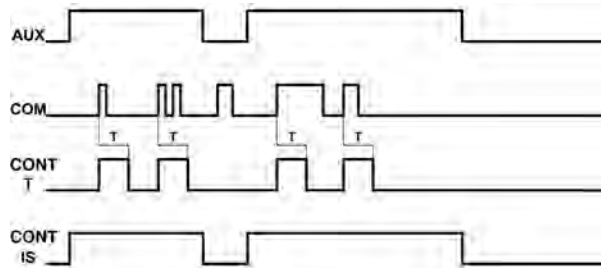

F6- One-shot function on "CONTROL" (COM).

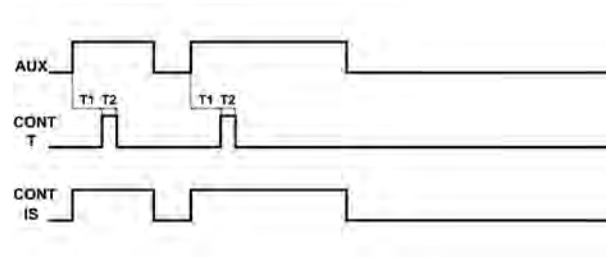

F7 – One-shot function with fixed pulse (3s), delayed at pick-up.

T1: adjustable by way of selector S3 / S4
 T2 : fixed, 3 seconds

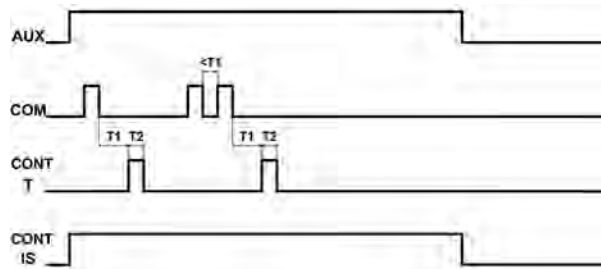

F8 – One-shot function, on "CONTROL", with fixed pulse (3s), delayed at pick-up.

T1: adjustable by way of selector S3 / S4
 T2 : fixed, 3 seconds
 Control signal ("COM", 1B terminal) starts time delay T1
 Control signal ("COM", 1B terminal) restarts the time, if this appears during the time delay.

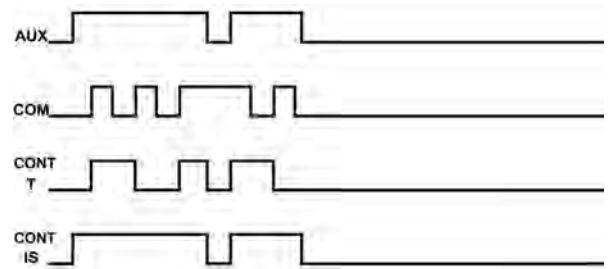

F9 - Step function

The S3 and S4 switches have no effect on the relay operation.

Applicable note for all operating diagrams:

- AUX: 2B - 1A terminals
- COM: 1B terminal
- CONT T: timed contacts
- CONT I: instantaneous contacts

See "Wiring diagram" to identify the instantaneous and timed contacts terminals'.

Electrical life expectancy ⁽¹⁾

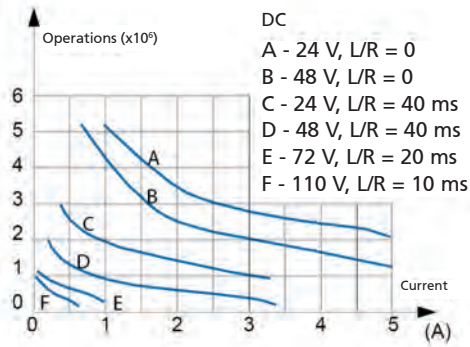

Some Examples of electrical life expectancy
 12 Vdc - 10 A - Resistive: 10^5 operations
 48 Vdc - 5 A - L/R 10 ms: 5×10^5 operations
 80 Vdc - 5 A - Resistive: 5×10^5 operations
 110 Vdc - 0,5 A - L/R 10 ms: 5×10^5 operations
 110 Vdc - 1 A - L/R 0 ms: 10^5 operations

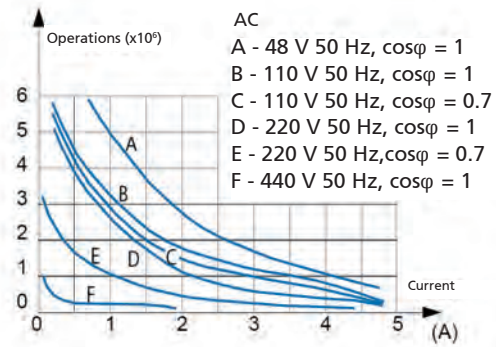

132 Vdc - 0,7 A - 132 Vdc - L/R 40 ms: 10^5 operations
 220 Vdc - 0,2 A - L/R 10 ms: 10^5 operations
 110 Vac - 5 A - $\cos\phi$ 0,7: 5×10^5 operations
 220 Vac - 3 A - $\cos\phi$ 0,7: 5×10^5 operations
 440 Vac - 0,2 A - Resistive: 5×10^5 operations

(1) Switching frequency 1,200 operations/hour, 50% cycle.

Sockets and retaining clips

Number of terminals (standard dimensions 5x0.8mm)	16	Retaining clip
For wall or rail mounting		
Spring clamp, wall or DIN H35 rail mounting	PAIR160	RT48
Screw, wall or DIN H35 rail mounting	48BIP20-I DIN	RT48
Screw, wall mounting	48BL	RT48
For flush mounting		
Spring clamp	PRIR160	RT48
Double faston (4.8 x 0.8 mm)	ADF2	RT48
Screw	43IL ⁽¹⁾	RT43
For mounting on PCB	65	RT43

(1) Insert the clip before fastening the socket on the panel.
 For more details, see specifications of mounting accessories.

Mounting tips

The preferred mounting position is on the wall, with the relay positioned horizontally in the reading direction on the nameplate. For correct use of the relays, they should be spaced apart by at least 5 mm in the horizontal direction and 20 mm in the vertical direction. This is to allow correct upward dissipation of the heat generated by the coil. Set these distances according to the socket used. Distances can be reduced depending on the environmental application conditions and on the relay duty cycle.

For safe and secure operation, it is advisable to use retaining clips.

No special maintenance is required.

Condensation can form inside the relay when powered up and the outside ambient temperature is cold; this is quite normal and does not affect the operation of the relay. The plastic materials of the relay do not possess hygroscopic properties.



RELAYS

MULTISCALE MONOSTABLE TIMER RELAYS WITH 4 CONTACTS

TM SERIES

USER SECTORS



Power generation



Nuclear



Power transmission



Rolling Stock



Fixed railway installations



Shipbuilding



Petroleum industry



Heavy industry

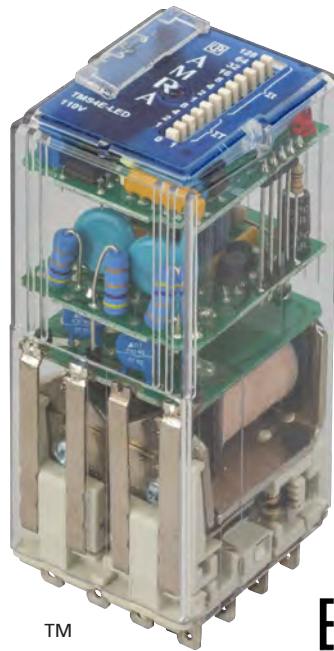

TM

EAC

PRODUCT ADVANTAGES

- Plug-in relay with time delay on pick-up or on drop-out
- 4 time delay contacts or 2 time delay contacts + 2 instantaneous contacts
- Wide time setting range from 0.1s to 9 hours, great accuracy over the entire adjustment range
- High electromagnetic interference immunity
- Solid and rugged construction for heavy or intensive duty
- Long life expectancy
- Independent and self-cleaning contacts
- Magnetic arc blow-out standard
- Separate arc breaking chambers
- Excellent shock and vibration resistance
- Wide variety of configurations and customizations
- Option for use in geothermal sites available
- Wide range of sockets
- Retaining clip for secure locking of relay on socket
- Transparent cover, pull-out handle
- Positive mechanical keying for relay and socket

DESCRIPTION

The **TM series** is a range of relays with electronic time delay on pick-up or drop-out, consisting of 8 models with 4 change-over contacts, from 5 to 10 A (nominal). They are obtained by assembling the electromechanical units of the POK or BIPOK series with a digital electronic circuit.

The electromechanical part features the **reliability and ruggedness** of relays belonging to the POK series, while the electronics offers high reliability thanks to the use of an electronic circuit requiring few components and to the careful choice of professional products.

With the same product it is possible to obtain switching times ranging from **0.1 second to over 9 hours**, with the greatest of accuracy over the entire setting range. This is thanks to the fact that the relay has 16 intermediate scales, freely selectable by the user.

Switching time is adjustable by means of two dipswitches, 4- and 8-bit respectively, located on the front of the relay. The 4-bit dipswitch serves for selecting the most suitable intermediate scale, while the 8-bit dipswitch is used for precision selection of the switching time.

On request, the models are available with fixed switching time to avoid modifications to the time setting.

The electronic circuit is immune to high electromagnetic interference, typical of high voltage electricity distribution stations.

The construction of the relays and careful choice of the materials are such that they ensure **long life** and considerable **ruggedness** even in harsh operating environments and in the presence of strong temperature fluctuations.

Excellent electrical and mechanical performance levels allow the product to be used in the most demanding of sectors such as, for example, control and signalling functions in electricity generating stations, electrical transformer stations, rail transport or in industries with continuous production processes (chemical industry, petroleum industry, rolling mills, cement factories, etc.). A specific treatment (P5GEO or P6GEO) combining coil tropicalization with gold-plated contacts allows the use of these items in geothermal electric power stations, as relays for signalling functions, for controlling intermediate devices and for all non-power circuits.

Above all, the excellent ability to withstand shock and vibration allow their use on rolling stock.

Models	Function		Nominal current		Number of contacts		Rolling stock application
	Pick-up	Drop-out	5 A	10 A	Time-delayed	Instantaneous	
TM2E	•		•		2	2	•
TM4E	•		•		4	-	•
TMS2E	•			•	2	2	•
TMS4E	•			•	4	-	•
TM2R		•	•		2	2	•
TM4R		•	•		4	-	•
TMS2R		•		•	2	2	•
TMS4R		•		•	4	-	•

FOR CONFIGURATION OF PRODUCT CODE, SEE "ORDERING SCHEME" TABLE

Coil specifications	
Nominal voltages Un ⁽¹⁾	DC: 12-24-36-48-72-96-110-125-132-144-220 AC: 12-24-48-110-127-220-230
Max. consumption at Un (DC/AC)	4 W / 5 VA
Operating range ⁽¹⁾	80...115% Un
Rolling stock version ^{(2) (3)}	DC: 70...125% Un
Type of duty	Continuous
Drop-out voltage ⁽⁴⁾	DC: > 5% Un AC: > 15% Un

1. Other values on request. - 2. See "Ordering scheme" table for order code. - 3. For operating ranges different to that specified by EN60077, refer to table "Rolling stock versions - Special Ranges". - 4. Limit value for supply voltage, expressed as % of the nominal value, beneath which the relay is certainly de-energized.

Contact specifications	TM2E - TM2R	TM4E - TM4R	TMS2E - TMS2R	TMS4E - TMS4R
Number and type	2 + 2 instantaneous CO, form C	4 CO, form C	2 + 2 instantaneous CO, form C	4 CO, form C
Current				
Nominal ⁽¹⁾	5 A		10 A	
Maximum peak (1 min) ⁽²⁾	10 A		20 A	
Maximum pulse (10 ms) ⁽²⁾	100 A		150 A	
EExample of electrical life expectancy ⁽³⁾	0.2 A – 110 Vdc – L/R = 40 ms: 10 ⁵ operations 0.7 A – 110 Vdc – L/R = 0 ms: 10 ⁵ operations		0.5 A – 110 Vdc – L/R = 40 ms: 10 ⁵ operations 1 A – 110 Vdc – L/R = 0 ms: 10 ⁵ operations	
Minimum load	500 mW (20 V, 20 mA)			
Standard contacts	100 mW (10 V, 5 mA)			
Gold-plated contact P4GEO ⁽⁴⁾	50 mW (5 V, 5 mA)			
Gold-plated contact P8 ⁽⁴⁾	250 Vdc / 350 Vac			
Maximum breaking voltage	AgCu			
Contact material	Ag / AgCu			
Operating time at Un (ms) ^{(5) (6)}	DC ⁽⁷⁾ – AC			
Pick-up (NO contact closing)	≤ 20 - ≤ 20			
Drop-out (NC contact closing)	≤ 15 - ≤ 20			

- On all contacts simultaneously, reduction of 30%.
- The max. peak and pulse currents are those currents that can be handled, for a specified time, by the contact. They do not refer to steady or interrupted currents.
- For other values, see electrical life expectancy curves.
- Specifications of contacts on new relay
 - Plating material: P4 GEO : gold-nickel alloy (>5μ) P8: gold-cobalt alloy (>5μ), knurled contact
 - When the gold-plated contact is subject to heavy loads, it will be degraded on the surface. In such case, the characteristics of the standard contact should be taken into consideration.
This does not impair relay operation.
- Times for the instantaneous component of the relay.
- Unless specified otherwise, the operating time signifies until stabilization of the contact (including bounces). It should be added to the preset delay time.
- Addition of a flyback diode connected in parallel with the coil (DC version only) causes an increase in operating time when the relay drops out.

Insulation	
Insulation resistance (at 500Vdc)	
between electrically independent circuits and between these circuits and ground	> 1,000 MΩ
between open contact parts	> 1,000 MΩ
Withstand voltage at industrial frequency	
between electrically independent circuits and between these circuits and ground	2 kV (1 min) - 2.2 kV (1 s)
between open contact parts	1 kV (1 min) - 1.1 kV (1 s)
between adjacent contacts	2.5 kV (1 min) - 3 kV (1 s)
Withstand voltage at industrial frequency (1.2/50μs – 0.5J)	
between electrically independent circuits and between these circuits and ground	5 kV
between open contact parts	3 kV



Mechanical specifications

	Mechanical life	DC: 20 x 10 ⁶ AC: 10 x 10 ⁶ operations
Maximum switching rate	Mechanical life expectancy	3,600 operations / hour
	Degree of protection (with relay mounted)	IP40
	Dimensions (mm) ⁽¹⁾	40 x 50 x 97
	Masse (g)	~ 220

(1) Excluding output terminals



Environmental specifications

Operating temperature	Standard	-25° to +55°C
	Version for railway, rolling stock	-25° to +70°C
Storage and shipping temperature		-40° to +85°C
Relative humidity		Standard: 75% RH Tropicalized: 95% RH
Resistance to vibrations		5g - 10 to 55 Hz - 1 min
Resistance to shock		20g – 11 ms
Fire behavior		V0



Standards and reference values

EN 61810-1, EN 61810-2, EN 61810-7 EN 61812-1 EN 60695-2-10 EN 61000 EN 60529	Electromechanical elementary relays Timer relays Fire behavior Electromagnetic compatibility Degree of protection provided by enclosures
---	--

Unless otherwise specified, the products are designed and manufactured according to the requirements of the above-mentioned European and International standards. In accordance with EN 61810-1, all items of technical data are referred to ambient temperature 23 °C, atmospheric pressure 96kPa and 50% humidity. Tolerance for coil resistance, nominal electrical input and nominal power is ±7%.



Railways, rolling stock - Standards

EN 60077 EN 50155 EN 61373 EN 45545-2 ASTM E162, E662 CU TR 001/2011	Electric equipment for rolling stock. General service conditions and general rules Electronic equipment used on rolling stock Rolling stock equipment. Shock and vibration tests, Cat 1 Class B Fire behavior, Cat E10, Requirement R26, V0 Fire behavior Safety of railway rolling stock - EAC certification
---	--



Railways, rolling stock – Special operating ranges ⁽¹⁾

Nominal voltage	Minimum pick-up voltage	Maximum operating voltage	Order symbol ⁽¹⁾
24 Vdc	18	33	Z01
24 Vdc	16	32	Z02
24 Vdc	16.8	32	Z03
72 Vdc	55	104	Z01
110 Vdc	77	144	Z01

(1) To request the special range, indicate the "Z0x" symbol in the "Keying position" field in the "Ordering scheme" table. The special range may be subject to operating specifications different from standard specifications. Please contact us for further information.



Configurations - Options

P2	Tropicalization of the coil with epoxy resin for use with 95% RH (@ T 50 °C). This treatment also protects the coil against corrosion which could occur by combination of the humidity with certain chemical agents, such as those found in acid atmospheres (typical of geothermal power stations) or saline atmospheres.
P4GEO	Gold plating of contacts with gold-nickel alloy, thickness $\geq 6\mu$. This treatment ensures long-term capacity of the contact to conduct lower currents in harsh ambient conditions such as acid atmospheres (typical of geothermal power stations) or saline atmospheres.
P5GEO	P4GEO gold-plating of contacts + P2 coil tropicalization.
P6GEO	P4GEO type gold-plating, but applied to contacts, contact terminals and output terminals + P2 coil tropicalization.
P7	AgCdO (silver cadmium oxide) contacts.
P8	Gold plating of contacts with gold-cobalt alloy, thickness $\geq 5\mu$, knurled fixed contact. This finish allows further improvement of the gold-plated contact performance compared to the treatment P4GEO.
LED	LED indicator showing presence of power supply, wired in parallel with the coil
FLYBACK DIODE	Polarized component connected in parallel with the coil (type 1N4007 or BYW56 for rolling stock version) designed to suppress overvoltages generated by the coil when de-energized.
TRANSIL	Non-polarized component connected in parallel with the coil. Behavior is similar to that of a varistor, with faster operating times.
LOW TEMPERATURE	Minimum operating temperature -50 °C , only for rolling stock version (option "L").



TM Ordering scheme

Product code	Application ⁽¹⁾	Configuration A	Configuration B	Label	Type of power supply	Nominal voltage (V) ⁽²⁾	Keying position ⁽³⁾ / options
TM2E TM4E TMS2E TMS4E	E: Energy Railway Fixed Equipment	1: Standard 2: Diode // 3: Varistor 4: Led	0 : Standard 2: P2 4: P4 GEO 5: P5 GEO 6: P6 GEO	F	C: Vdc A: Vac 50 Hz H: Vac 60 Hz	012 - 024 - 036 048 - 072 - 096 100 - 110 - 125 127 - 132 - 144 220 - 230	XXX
TM2R TM4R TMS2R TMS4R	R: Railway Rolling Stock	5: Diode // + Led 6: Varistor + Led 7: Transil 8: Transil + Led	7: P7 8: P8				L = low temperature

Example	TMS2R	E	4	2	F	A	230	
	TMS2RE42F-A230 - TMS2R relay, ENERGY series, nominal voltage 230 Vac, provided with LED, with P2 finish (tropicalized coil)							
	TM4R	R	1	8	F	C	024	L
	TM4RR18F-C024 - TM4R relay, ROLLING STOCK series, nominal voltage 24 Vdc, with P8 finish (gold-plated contacts) and option "L" (low temp.)							

(1) E = ENERGY: all applications, except for railways rolling stock.

Suitable on energy production, transport and distribution plants, railways fixed equipment, petrochemical and heavy industry.

R = RAILWAYS, ROLLING STOCK: Application on board rolling stock (rail-tram-trolley vehicles). Electrical characteristics according to EN60077.

Available also the product series:

RAILWAYS, FIXED EQUIPMENT: Approved and conforming relays and products to RFI (FS Group) specification no. RFI DPRIM STF IFS TE 143 A

For the list of RFI approved and conforming products, consult dedicated catalog "RAILWAY SERIES – RFI APPROVED".

STATIONS: ENEL approved material meeting LV15/LV16 specifications.

For the list of ENEL approved and conforming products, consult the dedicated catalog "STATIONS SERIES – LV15-LV16-LV20".

(2) Other values on request.

(3) Optional value. The positive mechanical keying is applied according to the manufacturer's model.

Wiring diagram

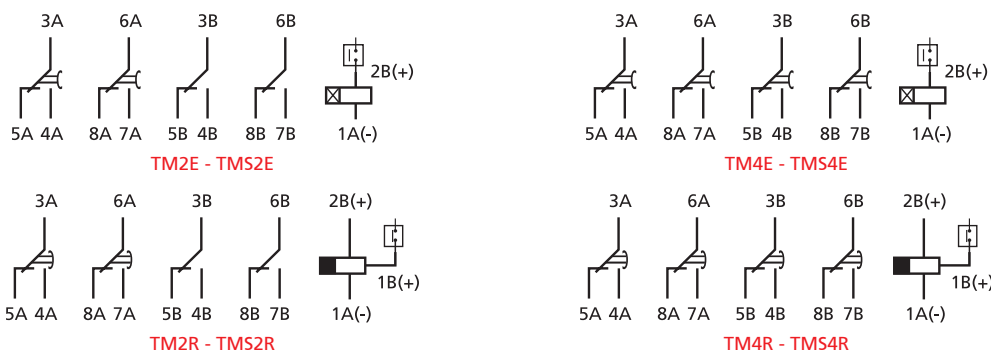

Relays with time delay on drop-out require an auxiliary power supply to ensure correct timing (terminal 2B)

Functional diagram

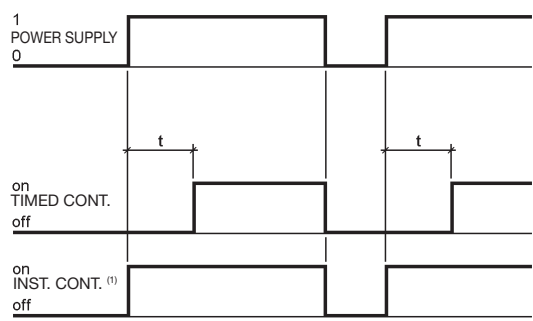

Time-delay on pick-up (version 2E, 4E)

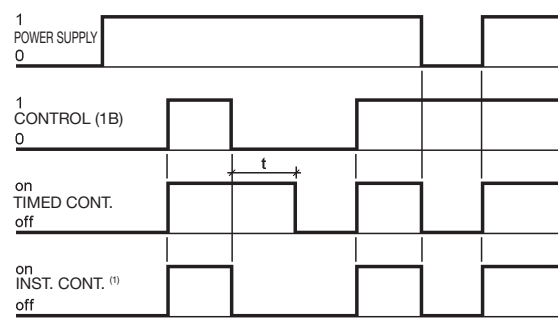

Time-delay on drop-out (version 2R, 4R)

⁽¹⁾ Instantaneous contacts are present only on versions "2E" and "2R"

Time delay – Switching time setting

Time setting	By means of DIP switches
Time setting range	100 ms...32,768 s
Intermediate scale	16, from 1 second to 32,768 seconds
Resolution of switching time setting	1/256 of the selected scale
Accuracy, time-delay ⁽¹⁾	± 1% of the switching time ± 0.5% of the scale
Accuracy, repeatability	DC : ± 0.5% AC : ± 0.5% + 20 ms
Reset	< 100ms in time-delay phase < 400ms
Insensitivity to voltage drops	< 100 ms

(1) Additional error for drop-out versions: 100 ms

The switching time is adjustable via the dipswitches (4- and 8-bit respectively) located on the front of the relay, through which it is possible to obtain time delays from 100 ms to 32,768 seconds (about 9 hours).

To adjust the switching time, the first step is to adjust the intermediate scale T(s), by selecting one of the 16 available scales using the 4-bit dipswitch. The values available are given in table 1.

The value of the T(s) scale should be the next highest numerically than the value of the required switching time.

E.g. Switching time: 3600 seconds → intermediate scale to set: 4096 seconds

The T(s) scale is set by identifying the switches that add up to the ΣT value indicated in table 1, and positioning them at "1".

Next, proceed to set the switching time by means of the 8-bit dipswitch.

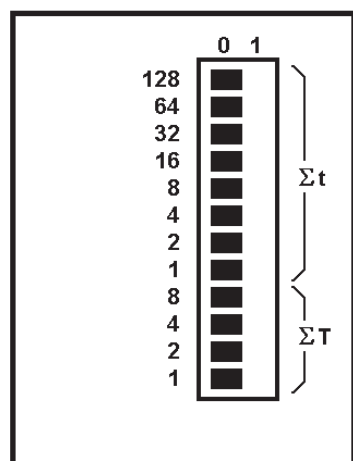

Σt
Switching time
dipswitches
(8bit)

Σ
Intermediate scale
dipswitches
(4 bit)

T(s)	ΣT	Switch reference			
		8	4	2	1
1	0	0	0	0	0
2	1	0	0	0	1
4	2	0	0	1	0
8	3	0	0	1	1
16	4	0	1	0	0
32	5	0	1	0	1
64	6	0	1	1	0
128	7	0	1	1	1
256	8	1	0	0	0
512	9	1	0	0	1
1 024	10	1	0	1	0
2 048	11	1	0	1	1
4 096	12	1	1	0	0
8 192	13	1	1	0	1
16 384	14	1	1	1	0
32 768	15	1	1	1	1

Table 1

The switching time is set by identifying the 16-bit dipswitches that add up to the Σt value, as calculated below, and positioning them at "1":

$$\Sigma t = \frac{t \times 256}{T} \text{ where } t(s) : \text{required switching time } T(s) : \text{full scale time set previously}$$

Example: Relay with time delay 22sec. and full scale time 32sec.

For the full scale time of 32 s, select value 5 in the ΣT column (see table), then identify the switches corresponding to 4 and 1 (4+1=5) and position them at "1". For the delay time of 22 s, set an Σt value of 176 (i.e. 22x256/32), then identify the switches corresponding to 128, 32 and 16 (128+32+16=176) and position them at "1".

Dimensions

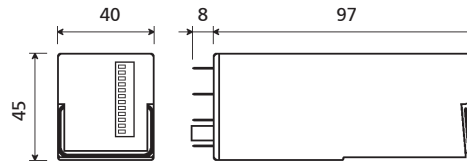

Electrical life expectancy ⁽¹⁾

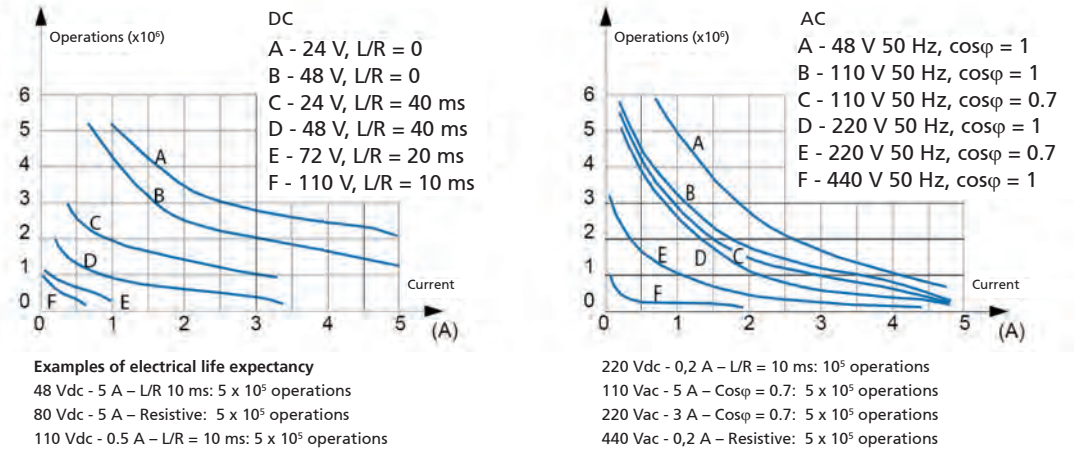

(1) Switching frequency 1200 operations/hour, cycle 50%.

Sockets

Number of terminals	16
For wall or rail mounting	
Spring clamp, wall or DIN H35 rail mounting	PAIR160
Screw, wall or DIN H35 rail mounting	48BIP20-I DIN
Screw, wall mounting	48BL
Double faston, wall mounting	48L
For flush mounting	
Double faston (4.8 × 0.8 mm)	ADF2
Screw	43IL
For mounting on PCB	
	65

For more details, see specifications of mounting accessories.

Retaining clips – correspondence with sockets

Number of clips per relay	1, 2 for use on rolling stock
SOCKET MODEL	CLIP MODEL
For wall or rail mounting	
PAIR160, 48BIP20-I DIN, 48BL, 48L	RT48
For flush mounting	
ADF2	RT48
43IL ⁽¹⁾	RT43
For mounting on PCB	
65	RT43

(1) Insert the clip before fastening the socket on the panel.

Mounting tips

The preferred mounting position is on the wall, with the relay positioned horizontally in the reading direction on the nameplate. For correct use of the relays, they should be spaced apart by at least 5 mm in the horizontal direction and 20 mm in the vertical direction. This is to allow correct upward dissipation of the heat generated by the coil. Set these distances according to the socket used. Distances can be reduced depending on the environmental application conditions and on the relay duty cycle. For safe and secure operation, it is advisable to use retaining clips. No special maintenance is required. Condensation can form inside the relay when powered up and the outside ambient temperature is cold; this is quite normal and does not affect the operation of the relay. The plastic materials of the relay do not possess hygroscopic properties.



RELAYS

TIMER RELAY WITH 4 CONTACTS

TOK SERIES

USER SECTORS



Power generation



Nuclear



Power transmission



Rolling Stock



Fixed railway installations



Shipbuilding



Petroleum industry



Heavy industry



TOK

PRODUCT ADVANTAGES

- TOK: Relay with time delay on pick-up or on drop-out
- Wide range of time settings available
- Solid and rugged construction for heavy or intensive duty
- Very long electrical life expectancy and exceptional endurance
- Independent and self-cleaning contacts with high breaking capacity
- Patent operating mechanism, designed to ensure high contact pressure
- Magnetic arc blow-out for higher breaking capacity
- Excellent shock and vibration resistance
- Wide range of sockets
- Retaining clip for secure locking of relay on socket
- Transparent cover, pull-out handle
- Positive mechanical keying for relay and socket

DESCRIPTION

The relays in the **TOK series** are monostable types with time delay, using 4 CO contacts. Manufactured following the same basic electromechanical design of the OK Series, they embody all the features and benefits of this product. These models are suitable for use in the most demanding of sectors such as, for example, electricity generating stations, electrical transformer stations, industries using continuous production processes, and railways - fixed equipment and rolling stock alike. An ample clearance between open contact elements is instrumental in ensuring optimum performance when breaking high loads. The use of a **magnetic arc blow-out** helps to achieve a considerable increase in breaking capacity, even when handling **highly inductive loads**.

TOK Series

The TOKe and TOKr relays provide time delays on **pick-up and drop-out respectively**, using 4 CO contacts. Intended originally for use in nuclear power plants, these relays are designed to guarantee particularly **high reliability and superior strength**. The time interval is adjusted by way of a potentiometer with a flat-head slotted screw, accessed from the top of the cover. A LED indicates energized status of the coil.

For further details of electromechanical construction, see chapter 1.2 "OK series".

Models	Function		Number of contacts	Magnetic arc blow-out	Adjustable	Fixed time delay, capacitor controlled	Rolling stock application
	Pick-up	Drop-out					
TOKe	•		4	•	•		•
TOKr		•	4	•	•		•

FOR CONFIGURATION OF PRODUCT CODE, SEE "ORDERING SCHEME" TABLE

Coil specifications		TOKe - TOKr
Nominal voltages Un ⁽¹⁾		DC: 24-36-48-72-110-125-132-144-220 AC: 24-48-110-125-220-230
Max. consumption at Un		4 W / VA
Operating range	standard	80...115% Un
	Rolling stock version ^{(1) (2)}	DC: 70...125% Un
	Type of duty	Continuous
	Drop-out voltage ⁽³⁾	> 5% Un

(1) Other values on request.

(2) See "Ordering scheme" table for order code.

(3) Limit value for supply voltage, expressed as % of the nominal value, beneath which the relay is certainly de-energized.

Contact specifications		TOKe - TOKr
Number and type		4 CO, form C
Current	Nominal ⁽¹⁾	10 A
	Maximum pulse (1 s) ⁽²⁾	20 A
	Maximum pulse (10 ms) ⁽²⁾	150 A
Example of electrical life expectancy ⁽³⁾	1,800 operations / h	0,7 A – 132 Vdc – L/R = 40 ms: 10 ⁵ operations
Minimum load	Standard contacts	500 mW (20 V, 20 mA)
	Gold-plated contacts P4GEO ⁽⁴⁾	100 mW (10 V, 5 mA)
Maximum breaking voltage		350 Vdc / 440 Vac
Contact material		AgCu
Operating time at Un (ms) ⁽⁵⁾	Pick-up (NO contact closing)	≤ 38
	Drop-out (NC contact closing)	DC: ≤ 8 AC: ≤ 80

(1) Nominal current: on all contacts simultaneously.

(2) The max. peak and pulse currents are those currents that can be handled, for a specified time, by the contact. They do not refer to steady or interrupted currents.

(3) For other values, see electrical life expectancy curves.

(4) Specifications of gold-plated contacts on new relay

a) Plating material: P4GEO : gold-nickel alloy (>6μ).

b) When the gold-plated contact is subject to heavy loads, it will be degraded on the surface. In such case, the characteristics of the standard contact should be taken into consideration. This does not impair relay operation.

(5) Unless specified otherwise, the operating time signifies until stabilization of the contact (including bounces). It should be added to the preset delay time.

(6) e(t) = DC < 15% / AC < 20% of selected time delay.

Insulation		
Insulation resistance (at 500Vdc)	between electrically independent circuits and between these circuits and ground	> 1,000 MΩ
	between open contact parts	> 1,000 MΩ
Withstand voltage at industrial frequency	between electrically independent circuits and between these circuits and ground	2 kV (1 min) - 2.2 kV (1 s)
	between open contact parts	2 kV (1 min) - 2.2 kV (1 s)
	between adjacent contacts	2 kV (1 min) - 2.2 kV (1 s)
Impulse withstand voltage (1.2/50μs - 0.5J)	between electrically independent circuits and between these circuits and ground	5 kV
	between open contact parts	5 kV



Mechanical specifications

	Mechanical life expectancy	20x10 ⁶ operations
Maximum switching rate	Mechanical	3,600 operations/hour
	Degree of protection (with relay mounted)	IP20
	Dimensions (mm)	45x45x109 ⁽¹⁾
	Weight (g)	~ 330

(1) Excluding output terminals



Environmental specifications

Operating temperature	Rolling stock version	-10 to + 55 °C
		-25 to + 70 °C
Storage and shipping temperature		-25 to + 85 °C
Relative humidity		Standard: 75% RH, Tropicalized: 95% RH
Resistance to vibrations		5g - 10 to 60 Hz - 1 min.
Resistance to shock		30g - 11ms
Fire behavior		V0



Standards and reference values

EN 61810-1, EN 61810-2, EN 61810-7	Electromechanical elementary relays
EN 61812-1	Timer relays
EN 60695-2-10	Fire behavior
EN 61000	Electromagnetic compatibility
EN 60529	Degree of protection provided by enclosures

Unless otherwise specified, the products are designed and manufactured according to the requirements of the above-mentioned European and International standards. In accordance with EN 61810-1, all items of technical data are referred to ambient temperature 23 °C, atmospheric pressure 96kPa and 50% humidity. Tolerance for coil resistance, nominal electrical input and nominal power is ±7%.



Railways, rolling stock - Standards

EN 60077	Electric equipment for rolling stock - General service conditions and general rules
EN 50155	Electronic equipment used on rolling stock
EN 61373	Shock and vibration tests, Cat 1, Class B
EN 45545-2	Fire behavior, Cat E10, Requirement R26, V0
ASTM E162, E662	Fire behavior



Configurations - Options

P2	Tropicalization of coil with epoxy resin for use with 95% RH (@ T 50 °C). This treatment also protects the coil against corrosion which could occur by combination of the humidity with certain chemical agents, such as those found in acid atmospheres (typical of geothermal power stations) or saline atmospheres.
P4GEO	Gold plating of contacts with gold-nickel alloy, thickness ≥ 6μ. This treatment ensures long-term capacity of the contact to conduct lower currents in harsh ambient conditions such as acid atmospheres (typical of geothermal power stations) or saline atmospheres.
P5GEO	P4GEO gold-plating of contacts + P2 coil tropicalization.
P6GEO	P4GEO type gold-plating, but applied to contacts, contact terminals and output terminals + P2 coil tropicalization.
LED	LED indicator showing presence of power supply, wired in parallel with the coil.



TOKx Ordering scheme

Product code	Application ⁽¹⁾	Configuration A	Configuration B	Label	Type of power supply	Nominal voltage (V) ⁽²⁾	Full scale time	Keying position ⁽³⁾
TOKe TOKr	E: Energy Railway Fixed Equipment R: Railway Rolling Stock	4: Led (as standard)	0: Standard 2: P2 4: P4 GEO 5: P5 GEO 6: P6 GEO	F	C: Vdc ⁽⁴⁾ A: Vac 50 Hz H: Vac 60 Hz	024 - 036 - 048 072 - 110 - 125 132 - 144 - 220 230	01S: 1 s 02S: 2 s 04S: 4 s 08S: 8 s 16S: 16 s 32S: 32 s 01M: 1 min 02M: 2 min 04M: 4 min 08M: 8 min 16M: 16 min 32M: 32 min 64M: 64 min	XXX

Example

TOKe	E	4	0	F	C	110	04S	
TOKeE40F-C110-04S - TOKe relay, ENERGY series, 110Vdc coil, full scale 4 seconds								
TOKr	R	4	4	F	C	024	08M	
TOKrR44F-C024-08M - TOKr relay, ROLLING STOCK series, 24Vdc coil, full scale 8 minutes, with P4GEO finish (gold-plated contacts)								

(1) **E = ENERGY:** all applications, except for railways rolling stock.

Suitable on energy production, transport and distribution plants, railways fixed equipment, petrolchemical and heavy industry.

R = RAILWAYS, ROLLING STOCK: Application on board rolling stock (rail-tram-trolley vehicles). Electrical characteristics according to EN60077.

Available also the product series:

RAILWAYS, FIXED EQUIPMENT: Approved and conforming relays and products to RFI (F5 Group) specification no. RFI DPRIM STF IFS TE 143 A

For the list of RFI approved and conforming products, consult dedicated catalog "RAILWAY SERIES – RFI APPROVED".

STATIONS: ENEL approved material meeting LV15/LV16 specifications.

For the list of ENEL approved and conforming products, consult the dedicated catalog "STATIONS SERIES – LV15-LV16-LV20".

(2) Other values on request.

(3) Optional value. The positive mechanical keying is applied according to the manufacturer's model.

(4) Rolling Stock version, Vdc only available.

MONOSTABLE
INSTANTANEOUS

INSTANTANEOUS
MONOSTABLE WITH
FORCIBLY GUIDED
CONTACTS

BISTABLE

FAST-ACTING
MONOSTABLE
(AND BISTABLE)

TIME DELAY
(ON PICKUP
OR DROP-OUT)

TIME DELAY WITH
FORCIBLY GUIDED
CONTACTS

MEASUREMENT

SOCKET
NUMBERING
EXPLANATIONS

FRONT
CONNECTION

BACK
CONNECTION

PCB MOUNT

RETAINING CLIPS

KEYING

Wiring diagram

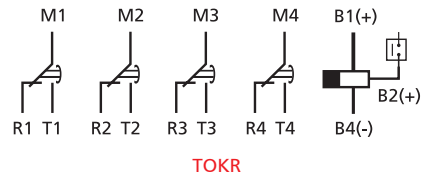
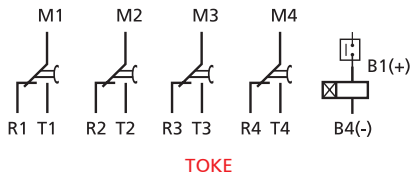

Functional diagram

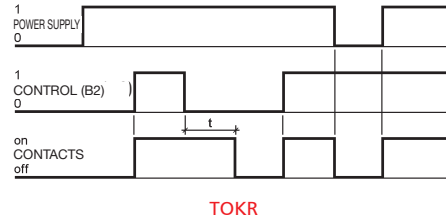
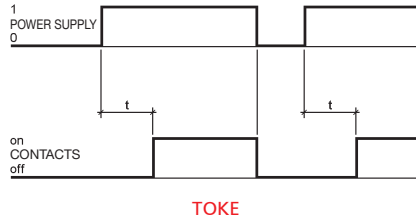

e(t): DC < 15% / AC < 20% of time t.



Time delay – Switching time setting

TOKe - TOKr

Time setting	By way of potentiometer, with slotted head screw
Full scale times available	1-2-4-8-16-32 seconds, 1-2-4-8-16-32-64 minutes
Time setting range	10...100 % of full scale
Accuracy, setting (0.8...1.1 Un, t=20°C)	± 5% of time delay
Accuracy, repeatability	DC: ± 0.5% / AC: ± 0.5% + 20ms
Reset	< 100ms - in time-delay phase < 1s

(1) The time varies by the same percentage as the input voltage fluctuation, within limits of ± 10%.

Dimensions

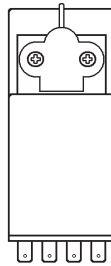
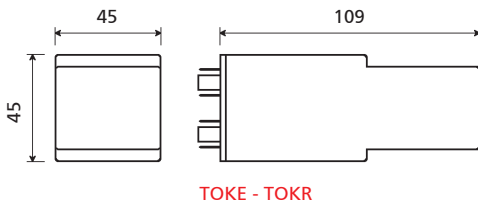

Finish for ROLLING STOCK version (TOK)

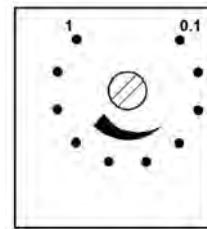

Time setting (TOK)
The scale shown on the relay (0.1-1) is approximate

Electrical life expectancy

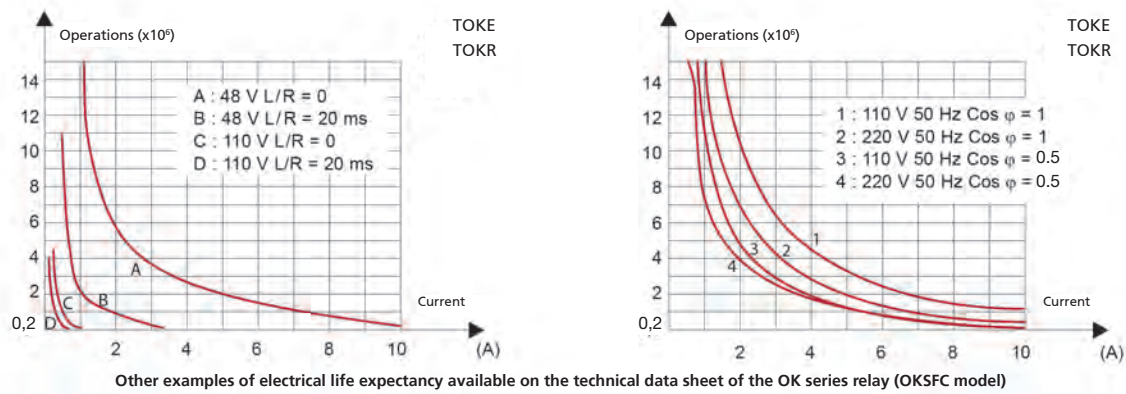

Sockets and retaining clips

Number of terminals (standard dimensions 5x0.8mm)	16	Retaining clip
For wall or rail mounting		
Spring clamp, wall or DIN H35 rail mounting	PAIR160	RL48
Screw, wall or DIN H35 rail mounting	48BIP20-I DIN	RL48
Screw, wall mounting	48BL	RL48
Double faston, wall mounting	48L	RL48
For flush mounting		
Double faston (4.8 x 0.8 mm)	ADF2	RL48
Screw	43IL ⁽¹⁾	RL43
For mounting on PCB	65	RL43

(1) Insert the clip before fastening the socket on the panel.
For more details, see specifications of mounting accessories.

Mounting tips

The preferred mounting position is on the wall, with the relay positioned horizontally in the reading direction on the nameplate. For correct use of the relays, they should be spaced apart by at least 5 mm in the horizontal direction and 20 mm in the vertical direction. This is to allow correct upward dissipation of the heat generated by the coil. Set these distances according to the socket used. Distances can be reduced depending on the environmental application conditions and on the relay duty cycle. For safe and secure operation, it is advisable to use retaining clips. No special maintenance is required. Condensation can form inside the relay when powered up and the outside ambient temperature is cold; this is quite normal and does not affect the operation of the relay. The plastic materials of the relay do not possess hygroscopic properties.



RELAYS

TIMER RELAY WITH 4 CONTACTS

OKT | OKR SERIES

USER SECTORS



Power generation



Nuclear



Power transmission



Rolling Stock



Fixed railway installations



Shipbuilding



Petroleum industry



Heavy industry



Time setting flat head slotted screw

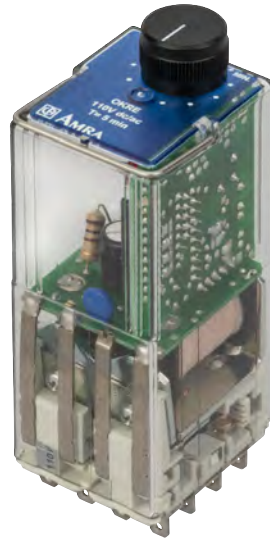

Time setting knob

PRODUCT ADVANTAGES

- Plug-in relay with time delay on pick-up or on drop-out
- Time delay setting from 0.1 second up to 1 hour
- Wide range of time settings available
- Operation using d.c. or a.c. power supply with a single product
- Solid and rugged construction for heavy or intensive duty
- Long life expectancy
- Separate arc breaking chambers
- Magnetic arc blow-out standard
- Independent and self-cleaning contacts
- Excellent shock and vibration resistance
- Wide range of sockets
- Retaining clip for secure locking of relay on socket
- Transparent cover, pull-out handle
- Positive mechanical keying for relay and socket

DESCRIPTION

The relays in the **OKR and OKT series** are monostable types with time delay, using 4 or 3 CO following the same basic electromechanical design of the POK model, they embody all the features and benefits of this product.

Excellent electrical and mechanical performance levels allow the product to be used in the most demanding of sectors such as, for example, control and signalling functions in electricity generating stations, electrical transformer stations, rail transport or in industries with continuous production processes (chemical industry, petroleum industry, rolling mills, cement factories, etc.). In particular, with their notable **shock and vibration resistance**, they are ideal for use on rolling stock.

The electronic timing circuit is designed using analog technology: by adopting a limited number of select components, the end product is guaranteed to meet high standards of quality and reliability.

OKRe and OKTa models offer time delay on pick-up, whereas **OKRr and OKTr models offer time delay on drop-out**. In the case of the OKTr model, one of the 4 contacts must be

connected to the power coil (see functional diagram). This obviates the need for connection of an auxiliary power supply to the relay, separate from the control. In this situation, the contacts available for switching purposes are 3 in number.

Models are available with different full scale time values (from 1 second up to 60 minutes), so as to offer a wide range of time delay settings. The full scale value is a fixed, factory set value determined as part of the manufacturing process. The end user can adjust the response time from a minimum 10% up to 100% of full scale with absolute ease, by way of the knob-operated or slotted screw-driven potentiometer located on the top of the relay housing. Power can be supplied to the relay from a d.c. or an a.c. source operating at 50 or 60 Hz.

For further details of electromechanical construction, see the chapter on the "POK series".

Models	Function		Number of time delayed contacts	Setting control		Rolling stock application	
	Pick-up	Drop-out		Knob	Flat head slotted screw		
OKTa	•		4	•	•	•	•
OKTr		•	3	•	•	•	•
OKRe	•		4	•	•	•	•
OKRr		•	4	•	•	•	•

FOR CONFIGURATION OF PRODUCT CODE, SEE "ORDERING SCHEME" TABLE

Coil specifications

Nominal voltages Un ⁽¹⁾	DC / AC: 24-36-48-72-110-125-132-144-220 -230
Max. consumption at Un (DC/AC)	4 W / 5 VA
Operating range ⁽¹⁾	80...115% Un
Rolling stock version ^{(2) (3)}	DC: 70...125% Un
Type of duty	Continuous
Drop-out voltage ⁽⁴⁾	> 5% Un

(1) Other values on request. Operation with d.c. or a.c. power supply.

(2) See "Ordering scheme" table for order code.

(3) For operating ranges different to that specified by EN60077, refer to table "Rolling stock versions - Special Ranges".

(4) Limit value for supply voltage, expressed as % of the nominal value, beneath which the relay is certainly de-energized.

Contact specifications

Contact specifications	OKTa	OKTr	OKRe - OKRr
Number and type	4 CO, form C	3 CO, form C	4 CO, form C
Current		5 A	
Nominal ⁽¹⁾		5 A	
Maximum peak (1 s) ⁽²⁾		10 A	
Maximum pulse (10ms) ⁽²⁾		100 A	
Example of electrical life expectancy ⁽³⁾	0.5A - 110 Vdc - L/R = 40 ms: 10 ⁵ operations, 1,800 operations/hour		
Minimum load		500 mW (20 V, 20 mA)	
Standard contacts		500 mW (20 V, 20 mA)	
Gold-plated contacts P4GEO ⁽⁴⁾		100 mW (10 V, 5 mA)	
Gold-plated contacts P8 ⁽⁴⁾		50 mW (5 V, 5 mA)	
Maximum breaking voltage	250 Vdc / 350 Vac		
Contact material	AgCu		
Switching time at Un (ms) ^{(5) (6)}		DC - AC	
Pick-up (NO contact closing)		≤ 20 - ≤ 20	
Drop-out (NC contact closing)		≤ 15 - ≤ 20	

(1) Nominal current: on all contacts simultaneously, reduction of 30%.

(2) The max. peak and pulse currents are those currents that can be handled, for a specified time, by the contact. They do not refer to steady or interrupted currents.

(3) 1,800 operations/hour - For other values, see electrical life expectancy curves.

(4) Specifications of gold-plated contacts on new relay

a) Plating material: **P4 GEO: gold-nickel alloy (>6μ)**

P8: gold-cobalt alloy (>5μ), knurled contact

b) When the gold-plated contact is subject to heavy loads, it will be degraded on the surface. In this case, the characteristics of the standard contact should be taken into consideration. This does not impair relay operation.

(5) Unless specified otherwise, the operating time signifies until stabilization of the contact (including bounces). It should be added to the preset delay time.

(6) Addition of a flyback diode connected in parallel with the coil (DC version only) causes an increase in operating time when the relay drops out.

Insulation

Insulation resistance (at 500Vdc)	
between electrically independent circuits and between these circuits and ground	> 1,000 MΩ
between open contact parts	> 1,000 MΩ
Withstand voltage at industrial frequency	
between electrically independent circuits and between these circuits and ground	2 kV (1 min) - 2.2 kV (1 s)
between open contact parts	1 kV (1 min) - 1.1 kV (1 s)
between adjacent contacts	2.5 kV (1 min) - 3 kV (1 s)
Impulse withstand voltage (1.2/50μs - 0.5J)	
between electrically independent circuits and between these circuits and ground	5 kV
between open contact parts	3 kV



Mechanical specifications

	Mechanical life expectancy	20x10 ⁶ operations
Maximum switching rate	Mechanical	3 600 operations/hour
	Degree of protection (with relay mounted)	IP40
	Dimensions (mm)	40x45x97 ⁽¹⁾
	Weight (g)	~ 220

(1) Excluding output terminals and adjuster knob, if specified.



Environmental specifications

Operating temperature	Standard	-10 to +55 °C
	Version for rolling stock	-25 to +70 °C
Storage and shipping temperature		-25 to +85 °C
Relative humidity		Standard: 75% RH, Tropicalized: 95% RH
Resistance to vibrations		5g - 10 to 55 Hz - 1 min.
Resistance to shock		20g - 11ms
Fire behavior		V0



Standards and reference values

EN 61810-1, EN 61810-2, EN 61810-7	Electromechanical elementary relays
EN 61812-1	Timer relays
EN 60695-2-10	Fire behavior
EN 61000	Electromagnetic compatibility
EN 60529	Degree of protection provided by enclosures

Unless otherwise specified, the products are designed and manufactured according to the requirements of the above-mentioned European and International standards. In accordance with EN 61810-1, all items of technical data are referred to ambient temperature 23 °C, atmospheric pressure 96kPa and 50% humidity. Tolerance for coil resistance, nominal electrical input and nominal power is ±7%.



Railways, rolling stock - Standards

EN 60077	Electric equipment for rolling stock - General service conditions and general rules
EN 50155	Electronic equipment used on rolling stock
EN 61373	Shock and vibration tests, Cat 1, Class B
EN 45545-2	Fire behavior, Cat E10, Requirement R26, V0
ASTM E162, E662	Fire behavior



Railways, rolling stock – Special operating ranges

Nominal voltage	Minimum pick-up voltage	Maximum operating voltage	Order symbol ⁽¹⁾
24 Vdc	18	33	Z01
72 Vdc	55	104	Z01
110 Vdc	77	140	Z01
128 Vdc	85	155	Z01

(1) To order the relay with the special operating range, indicate the "Z0x" symbol in the "Keying position" field of the ordering scheme. The special range may be subject to operating specifications different from standard specifications. Please contact us for further information.



Configurations - Options

P2	Tropicalization of coil with epoxy resin for use with 95% RH (@ T 50 °C). This treatment also protects the coil against corrosion which could occur by the combination of humidity with certain chemical agents, such as those found in acid atmospheres (typical of geothermal power stations) or saline atmospheres
P4GEO	Gold plating of contacts with gold-nickel alloy, thickness ≥ 6μ. This treatment ensures long-term capacity of the contact to conduct lower currents in harsh ambient conditions such as acid atmospheres (typical of geothermal power stations) or saline atmospheres.
P5GEO	P4GEO type gold-plating + P2 coil tropicalization.
P6GEO	Gold-plating of contacts, contact terminals and output terminals + P2 coil tropicalization.
P7	Silver cadmium oxide contacts.
P8	Gold plating of contacts with gold-cobalt alloy, thickness ≥ 5μ, knurled fixed contact. This finish allows further improvement of the gold-plated contact performance compared to the treatment P4GEO.
LED	LED indicator showing presence of power supply, wired in parallel with the coil.
FLYBACK DIODE	Polarized component connected in parallel with the coil (type 1N4007 or BYW56 for rolling stock version) designed to suppress overvoltages generated by the coil when de-energized.
TRANSIL	Non-polarized component connected in parallel with the coil. Behavior is similar to that of a varistor, with faster operating times.



Ordering scheme

Product code	Application ⁽¹⁾	Configuration A	Configuration B	Label	Type of power supply	Nominal voltage (V) ⁽²⁾	Setting control	Full scale time	Keying position ⁽³⁾
OKRe OKTa OKRr OKTr	E: Energy Railway Fixed Equipment R: Railway Rolling Stock	1: Standard 2: Diode // 3: Varistor 4: Led 5: Diode // + Led 6: Varistor + Led 7: Transil 8: Transil + Led	0: Standard 2: P2 4: P4 GEO 5: P5 GEO 6: P6 GEO 7: P7 8: P8	F	T: Vdc/ac C: Vdc ⁽⁴⁾	024 - 036 - 048 072 - 110 - 125 132 - 144 - 220 230	M: Knob C: Flat head slotted screw	01S: 1 s 05 : 5 s 10S: 10 s 15S: 15 s 30S: 30 s 01M: 1 min 02M: 2 min 05M: 5 min 10M: 10 min 15M: 15 min 30M: 30 min 60M: 60 min	XXX

Example	OKRe	E	1	0	F	T	110	M	05S	
	OKReE10F-T110-M05S - OKRe relay, ENERGY series, nominal voltage 110Vdc, full scale 5 seconds, knob setting control									
	OKRr	R	5	0	F	C	072	C	30M	
OKRrR50F-C072-C30M - OKRr relay, rolling stock series, nominal voltage 72Vdc, special range 55-104V, equipped with diode, led, full scale 30 minutes, slotted screw setting control										

(1) E = ENERGY: all applications, except for railways rolling stock.

Suitable on energy production, transport and distribution plants, railways fixed equipment, petrolchemical and heavy industry.

R = RAILWAYS, ROLLING STOCK: Application on board rolling stock (rail-tram-trolley vehicles). Electrical characteristics according to EN60077.

Available also the product series:

RAILWAYS, FIXED EQUIPMENT: Approved and conforming relays and products to RFI (FS Group) specification no. RFI DPRIM STF IFS TE 143 A

For the list of RFI approved and conforming products, consult dedicated catalog "RAILWAY SERIES - RFI APPROVED".

STATIONS: ENEL approved material meeting LV15/LV16 specifications.

For the list of ENEL approved and conforming products, consult the dedicated catalog "STATIONS SERIES - LV15-LV16-LV20".

(2) Other values on request.

(3) Optional value. The positive mechanical keying is applied according to the manufacturer's model.

(4) Rolling Stock version, Vdc only available.

Functional diagram

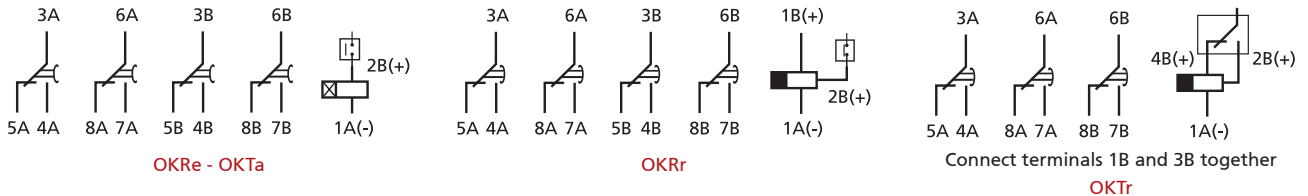

Functional diagram

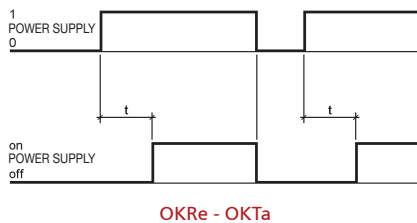

OKRe - OKTa

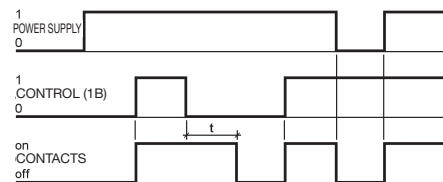

OKRr-OKTr



Time delay - Switching time setting

Time setting	By way of potentiometer, with knob or flat head slotted screw setting control
Full scale times available	1-5-10-15-30 seconds, 1-2-5-10-30-60 minutes
Time setting range	10...100 % of full scale
Accuracy, setting (0.8...1.1 Un, t=20°C)	± 10% of time delay
Accuracy, repeatability	± 0.5% (Vdc) - ± 0.5% + 20ms (Vac)
Reset	< 100ms - in time-delay phase < 1s

The setting scale shown on the front of the relay (0.1 ... 1) is approximate.

Dimensions

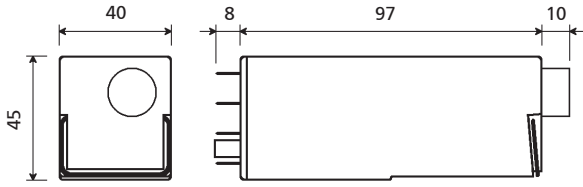

Relay with knob setting control

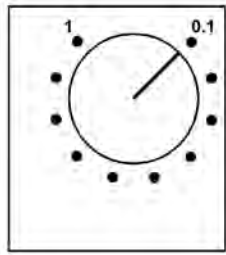

Knob setting control

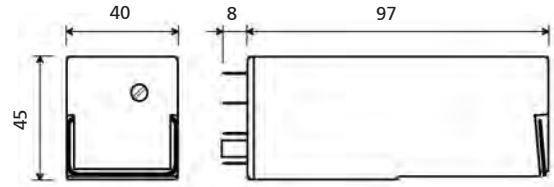

Relay with flat head slotted screw setting control

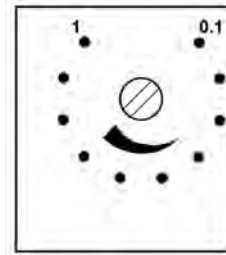

Flat head slotted screw setting control

The scale shown on the relay (0.1-1) is approximate

Electrical life expectancy

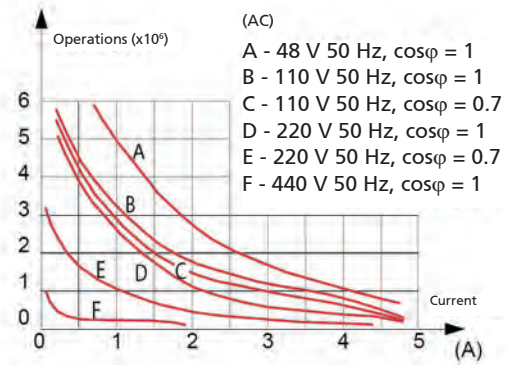
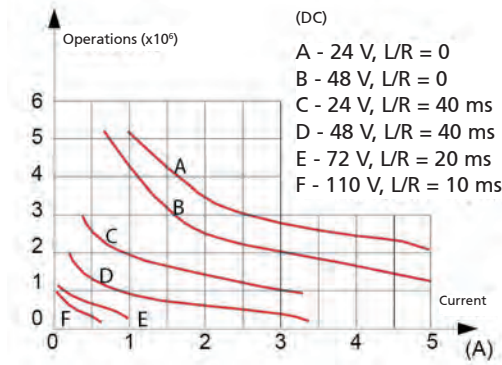

Some examples of electrical life expectancy

48 Vdc - 5 A - L/R = 10 ms: 5×10^5 operations
 80 Vdc - 5 A - Resistive: 5×10^5 operations
 110 Vdc - 0,5 A - L/R = 10 ms: 5×10^5 operations

220 Vdc - 0,2 A - L/R = 10 ms: 10^5 operations
 110 Vac - 5 A - $\cos\phi = 0.7$: 5×10^5 operations
 220 Vac - 3 A - $\cos\phi = 0.7$: 5×10^5 operations
 440 Vac - 0,2 A - Resistive: 5×10^5 operations

(1) Switching frequency 1,200 operations/hour, 50% cycle.

Sockets and retaining clips

Number of terminals (standard dimensions 5x0.8mm)	16	Retaining clip
For wall or rail mounting		
Spring clamp, wall or DIN H35 rail mounting	PAIR160	RC48
Screw, wall or DIN H35 rail mounting	48BIP20-I DIN	RC48
Screw, wall mounting	48BL	RC48
Double faston, wall mounting	48L	RC48
For flush mounting		
Double faston (4.8 × 0.8 mm)	ADF2	RC48
Screw	43IL ⁽¹⁾	RC43
For mounting on PCB	65	RC43

(1) Insert the clip before fastening the socket on the panel.
For more details, see specifications of mounting accessories.

Mounting tips

The preferred mounting position is on the wall, with the relay positioned horizontally in the reading direction on the nameplate. For correct use of the relays, they should be spaced apart by at least 5 mm in the horizontal direction and 20 mm in the vertical direction. This is to allow correct upward dissipation of the heat generated by the coil. Set these distances according to the socket used. Distances can be reduced depending on the environmental application conditions and on the relay duty cycle. For maximum reliability in operation, it is advisable to use retaining clips. No special maintenance is required. Condensation can form inside the relay when powered up and the outside ambient temperature is cold; this is quite normal and does not affect the operation of the relay. The plastic materials of the relay do not possess hygroscopic properties.



RELAYS

MULTI-SCALE TIMER RELAYS

UTM SERIES

USER SECTORS



Power generation



Nuclear



Power transmission



Rolling Stock



Fixed railway installations



Shipbuilding



Petroleum industry



Heavy industry



UTM

PRODUCT ADVANTAGES

- Static timer unit, operating on pick-up or drop-out
- Compact dimensions
- Timer control suitable for all our relays
- Wide time setting range from 0.1s to 9 hours, great accuracy over the entire adjustment range
- Availability of 2 outputs: timed and instantaneous
- Led indicating power-up status
- Time setting with dials
- High electromagnetic interference immunity
- Solid and rugged construction for heavy or intensive duty
- Wide range of sockets
- Retaining clip for secure locking of unit on socket
- Transparent cover

DESCRIPTION

The **UTM unit** is a **static timer** module, designed for applications requiring a time delay activated on pick-up or on drop-out.

Offered in 2 versions, these units can be used to control an external load, introducing a delay either **on pick-up** (UTME) or **on drop-out** (UTMR).

There are 2 outputs available: one timed, the other instantaneous, with maximum rated power 6W.

The UTM offers high reliability, thanks to the use of an electronic circuit requiring few components, and to the selection of professional grade products.

Switching times ranging from 0.1 second to over 9 hours are obtainable, with extreme accuracy guaranteed over the entire setting range. This is made possible as the module has 16 intermediate scales, freely selectable by the user.

Switching time is adjustable by means of two dials, 4- and 8-bit respectively, located on the front of the relay. The 4-bit dial allows selection of the most suitable intermediate scale, whilst the 8-bit dial is used for selection of the exact switching time.

The electronic circuit is **immune to high electromagnetic interference, typical of high voltage electricity distribution stations.**

The construction of the module and careful choice of the materials are such as to ensure long life and considerable strength even in harsh operating environments and in the presence of strong temperature fluctuations.

In particular, with its notable shock and vibration resistance, the unit is ideal for use on rolling stock

Models	Function		Output		Rolling stock application
	Pick-up	Drop-out	Instantaneous	Time-delayed	
UTME	•		•	•	•
UTMR		•	•	•	•

FOR CONFIGURATION OF PRODUCT CODE, SEE "ORDERING SCHEME" TABLE

Power supply data

Nominal voltages Un ⁽¹⁾	DC: 24-36-72-110-128
Max. consumption at Un (DC/AC)	0.6 W
Operating range ⁽¹⁾	80...115% Un
Rolling stock version ⁽²⁾	70...125% Un
Type of duty	Continuous
Maximum power at outputs	6 W (total)

1. Other values on request. - 2. See "Ordering scheme" table for order code.

Insulation

Insulation resistance (at 500Vdc) between electrically independent circuits and between these circuits and ground	> 1,000 MΩ
Withstand voltage at industrial frequency between electrically independent circuits and between these circuits and ground	2 kV (1 min) - 2.2 kV (1 s)
Impulse withstand voltage (1.2/50μs - 0.5J) between electrically independent circuits and between these circuits and ground	5 kV

Mechanical Specifications

Degree of protection (with unit mounted)	IP40
Dimensions (mm) ⁽¹⁾	40 x 40 x 50
Weight (g)	~ 60

1. Output terminals excluded.

Environmental specifications

Operating temperature	Standard -25° to +55°C
Version for railways, rolling stock	-25° to +70°C
Storage and shipping temperature	-40° to +85°C
Relative humidity	Standard: 75% RH
Resistance to vibrations	5g - 10 to 55 Hz - 1 min
Resistance to shock	20g - 11 ms
Fire behavior	V0

Standards and reference values

EN 61812-1	Timer relays
EN 60695-2-10	Fire behavior
EN 61000	Electromagnetic compatibility
EN 60529	Degree of protection provided by enclosures

Unless otherwise specified, products are designed and manufactured to the requirements of the European and International standards indicated above. In accordance with EN 61810-1, all items of technical data are referred to ambient temperature 23 °C, atmospheric pressure 96kPa and 50% humidity. Tolerance for coil resistance, nominal electrical input and nominal power is ±7%.

Railways, rolling stock - Standards

EN 60077	Electric equipment for rolling stock - General service conditions and general rules Electronic equipment used on rolling stock Shock and vibration tests, Cat 1, Class B Fire behavior, Cat E10, Requirement R26, V0 Fire behavior
EN 50155	
EN 61373	
EN 45545-2	
ASTM E162, E662	

Configurations - Options

LOW TEMPERATURE	Minimum operating temperature -50°C, only for rolling stock version (option "L")
-----------------	--

MONOSTABLE
INSTANTANEOUS

INSTANTANEOUS
MONOSTABLE WITH
FORCIBLY GUIDED
CONTACTS

BISTABLE

FAST-ACTING
MONOSTABLE
(AND BISTABLE)

TIME DELAY
(ON PICKUP
OR DROP-OUT)

TIME DELAY WITH
FORCIBLY GUIDED
CONTACTS

MEASUREMENT

SOCKET
NUMBERING
EXPLANATIONS

FRONT
CONNECTION

BACK
CONNECTION

PCB MOUNT

RETAINING CLIPS



UTM Ordering scheme

Product code	Application ⁽¹⁾	Configuration A	Configuration B	Label	Type of power supply	Nominal voltage (V) ⁽²⁾	Keying position ⁽³⁾ / Options
UTME	E: Energy						XXX
UTMR	R: Railway Rolling Stock	1: Standard	0: Standard	F	C: Vdc	024 - 036 072 - 110	L = Low temperature

Example	UTME	E	1	0	F	C	110	
	UTMEE10F-C110 - UTME unit, ENERGY series, nominal voltage 110Vdc							
	UTMR	R	1	0	F	C	024	L
	UTMRR10F-C024L - UTMR unit, ROLLING STOCK series, nominal voltage 24 Vdc, with option "L" (low temp.)							

(1) ENERGY: all applications except for railway.

RAILWAY, ROLLING STOCK: Application on board rolling stock (rail-tram-trolley vehicles). Electrical specifications according to EN60077.

(2) Other values on request.

(3) Optional value. Multiple selection possible. Positive mechanical keying is applied according to the manufacturer's model.



Timing - Time delay setting

Time setting	By means of dipswitches
Time setting range	100 ms...32,768 s
Intermediate scales	16, from 1 second to 32,768 seconds
Resolution of operating time setting	1/256 of selected scale
Accuracy, time-delay ⁽¹⁾	± 1% of the switching time ± 0.5% of the scale
Accuracy, repeatability	DC: ± 0.5% AC: ± 0.5% + 20 ms
Reset	< 100 ms in time-delay phase < 400ms
Insensitivity to power losses	< 100 ms

(1) Additional error for drop-out versions: 100 ms

The switching time is adjustable by way of two dipswitches (4- and 8-bit respectively) located on the front of the relay, which can be used to set time delays from 100 ms to 32,768 seconds (approximately 9 hours).

To determine the switching time, the first step is to adjust the intermediate scale T(s), by selecting one of the 16 available settings with the 4-bit dipswitch. The values available are given in table 1.

The value of the T(s) scale should be the next highest numerically than the value of the required switching time.

E.g. Switching time: 3,600 seconds → intermediate scale setting: 4,096 seconds

The T(s) scale is set by identifying the switches that add up to the ΣT value indicated in table 1, and positioning them at "1".

Next, proceed to set the switching time by means of the 8-bit dipswitch.

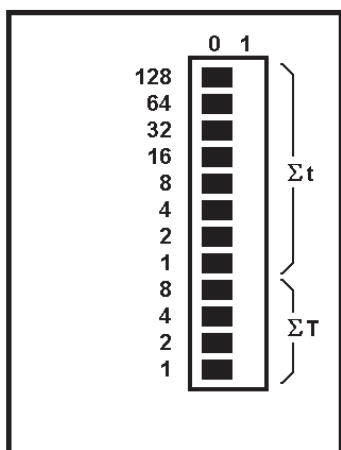

Σt
Time setting
dipswitches
(8-bit)

ΣT
Intermediate scale
dipswitches
(4 bit)

T(s)	ΣT	Switch reference			
		8	4	2	1
1	0	0	0	0	0
2	1	0	0	0	1
4	2	0	0	1	0
8	3	0	0	1	1
16	4	0	1	0	0
32	5	0	1	0	1
64	6	0	1	1	0
128	7	0	1	1	1
256	8	1	0	0	0
512	9	1	0	0	1
1024	10	1	0	1	0
2048	11	1	0	1	1
4096	12	1	1	0	0
8192	13	1	1	0	1
16384	14	1	1	1	0
32768	15	1	1	1	1

Table 1

The switching time is set by identifying the 16-bit dipswitches that add up to the Σt value, as calculated below, and positioning them at "1":

$$\Sigma t = \frac{t \times 256}{T} \quad \text{where } t(s) : \text{required switching time } T(s) : \text{full scale time set previously}$$

Example: relay with time delay 22 s. and full scale time 32 s.

For the full scale time of 32 s, select value 5 in the ΣT column (see table), then identify the switches corresponding to 4 and 1 (4+1=5) and position them at "1". For the delay time of 22 s, set an Σt value of 176 (i.e. 22x256/32), then identify the switches corresponding to 128, 32 and 16 (128+32+16=176) and position them at "1".

Wiring diagram

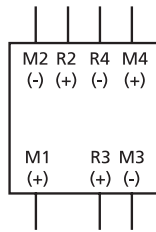

M3 - R3 = POWER SUPPLY
 M1 = CONTROL SIGNAL
 M4 - R4 = TIMED OUTPUT
 R2 - M2 = INSTANTANEOUS OUTPUT

Dimensions

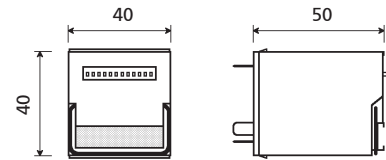

Functional diagram

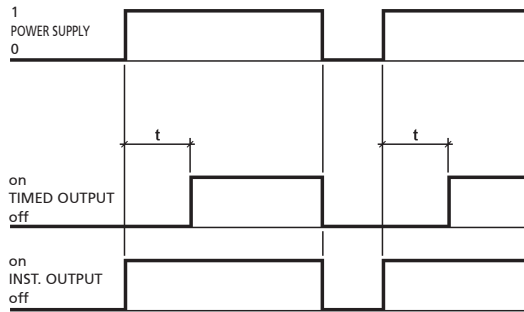

UTME

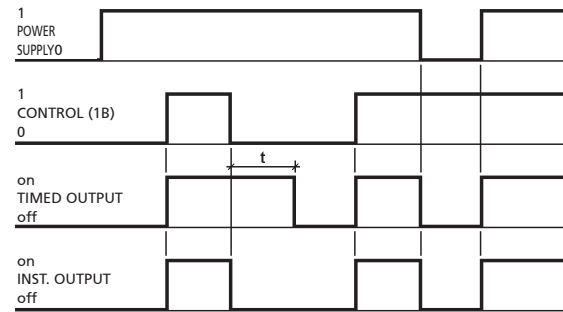

UTMR

Sockets

	Number of terminals	16
For wall or rail mounting		
Spring clamp, wall or DIN H35 rail mounting		PAIR160
Screw, wall or DIN H35 rail mounting		48BIP20-I DIN
Screw, wall mounting		48BL
For flush mounting		
Screw		43IL
For mounting on PCB		
		65

For more details, see specifications of mounting accessories.

Retaining clips - correspondence with sockets

	Number of clips per relay	
SOCKET MODEL		CLIP MODEL
For wall or rail mounting		
PAIR160, 48BIP20-I DIN, 48BL		RPB48
For flush mounting		
ADF2		RPB48
43IL ⁽¹⁾		RPB43
For mounting on PCB		
65		RPB43

(1) Insert the clip before fastening the socket on the panel.

Mounting tips

The preferred mounting position is on the wall, with the module positioned horizontally in the reading direction on the nameplate. For correct use, modules should be spaced apart by at least 5 mm in the horizontal direction and 20 mm in the vertical direction. This is to allow correct upward dissipation of the heat generated. Set these distances according to the socket used. Distances can be reduced depending on the environmental conditions during operation, and on the relay duty cycle. For safe and secure operation, it is advisable to use retaining clips. No special maintenance is required.



RELAYS

LOGIC RELAYS: FLASHERS & ONE-SHOT

TOK-L | OKRE-L | TOK-FP | OKRE-FP CLE SERIES

USER SECTORS



Power generation



Nuclear



Power transmission



Rolling Stock



Fixed railway installations



Shipbuilding



Petroleum industry



Heavy industry



TOK Series



OKRe Series,
flat head slotted screw
setting control



OKRe Series,
knob setting control

PRODUCT ADVANTAGES

- "L": flasher function with symmetrical output pulse, adjustable or fixed
- "FP": one-shot function, adjustable
- Wide range of time settings available
- Solid and rugged construction for heavy or intensive duty
- Long life expectancy
- Patent operating mechanism, designed to ensure high contact pressure (TOK)
- Independent and self-cleaning contacts
- Magnetic arc blow-out standard
- Excellent shock and vibration resistance
- Wide range of sockets
- Retaining clip for secure locking of relay on socket
- Transparent cover, pull-out handle
- Positive mechanical keying for relay and socket

DESCRIPTION

5 models of "FLASHER" or "ONE SHOT" logic relays are available, derived from the TOK and OKR series. The **TOK-L**, **OKRe-L** and **CLE** models are flasher type relays, whereas the **TOK-FP** and **OKRe-FP** models are one-shot relays. The relays in the TOK series provide higher breaking capacity and longer mechanical life expectancy than those in the OKR / CLE series.

Flasher relays: when the component is energized, the coil of the relay is piloted by an electronic circuit, delivering voltage pulses in a continuous symmetrical ON/OFF cycle. Accordingly, the contacts change status cyclically, for as long as the control voltage is applied to the circuit. These relays can be specified with an adjustable or fixed intermittence frequency; in the case of an adjustable frequency, the setting is made by way of a potentiometer having a knob type or flat head slotted screw type control.

One-shot relay: Lorsque le relais est alimenté, la bobine when the component is energized, the coil of the relay is piloted by an electronic circuit, delivering voltage pulses. Accordingly, the contacts change status instantaneously and return to the break conditions after a predetermined interval of time, even with the control voltage applied to the circuit. Relays can be provided with a pulse of adjustable duration or a pulse of fixed duration. In the case of an adjustable pulse, the setting is made by way of a potentiometer having a knob type or a flat head slotted screw type control. Excellent electrical and mechanical performance levels allow the product to be used in the most demanding of sectors such as, for example, in electricity generating stations, electrical transformer stations, rail transport or in industries using continuous production processes (chemical and petrochemical, rolling mills, cement factories, etc.). In particular, with their notable shock and vibration resistance, they are ideal for use on rolling stock.

Models	Logic Function	Number of contacts	Range of contacts	Output	Setting control		Rolling stock application
					Knob	Flat head slotted screw	
OKRe-L	Flasher	4	5A	50%ON / 50%OFF adjustable up to 1h	•	•	•
TOK-L		4	10A	50%ON / 50%OFF adjustable up to 1h		•	•
CLE		4	5A	50%ON / 50%OFF, fixed 55 – 90 pulse/min	-	-	
OKRe-FP	One-shot	4	5A	Adjustable up to 1h	•	•	•
TOK-FP		4	10A	Adjustable up to 1h		•	•

FOR CONFIGURATION OF PRODUCT CODE, SEE "ORDERING SCHEME" TABLE

Coil specifications	
Nominal voltages Un (1)	DC: 24-36-48-72-110-125-132-144-220 AC: 24-48-110-125-220-230
Max. consumption at Un (DC/AC)	4 W / 4 VA
Operating range ⁽¹⁾	80...115 % Un DC : 70...125 % Un
Rolling stock version ⁽²⁾	
Type of duty	Continuous

(1) Other values on request.

(2) See "Ordering scheme" table for order code.

Contact specifications		CLE	OKRe-L	OKRe-FP	TOK-L	TOK-FP
Number and type	4 CO, form C					
Current	Nominal ⁽¹⁾	5 A			10 A	
	Maximum peak (1s) ⁽²⁾	10 A			20 A	
	Maximum pulse (10ms) ⁽²⁾	100 A			150 A	
Example of electrical life expectancy ⁽³⁾	0.2 A – 110 Vdc – L/R 0 ms : 10 ⁵ operations - 1,800 operations / hour			0.5 A – 110 Vdc – L/R 40 ms : 10 ⁵ - 1,800 operations / hour		
Minimum load	Standard contacts	500 mW (20V, 20 mA)				
	Gold-plated contacts P4GEO ⁽⁴⁾	100 mW (10V, 5 mA)			200mW (20 V, 5 mA)	
	Gold-plated contacts P8 ⁽⁴⁾	50 mW (5V, 5 mA)			-	
Maximum breaking voltage	250 Vdc / 350 Vac			350 Vdc / 440 Vac		
Contact material	AgCu					

(1) Nominal current: on all contacts simultaneously, reduction of 30%.

(2) The max. peak and pulse currents are those currents that can be handled, for a specified time, by the contact. They do not refer to steady or interrupted currents.

(3) For other values, see electrical life expectancy curves.

(4) Specifications of gold-plated contacts on new relay

a) Plating material: P4 GEO: gold-nickel alloy (>6μ) P8: gold-cobalt alloy (>5μ), knurled contact.

b) When the gold-plated contact is subject to heavy loads, it will be degraded on the surface. In this case, the characteristics of the standard contact should be taken into consideration.

This does not impair relay operation.

Insulation	CLE	OKRe-L	OKRe-FP	TOK-L	TOK-FP
Insulation resistance (at 500Vdc) between electrically independent circuits and between these circuits and ground between open contact parts	> 1,000 MΩ > 1,000 MΩ				
Withstand voltage at industrial frequency between electrically independent circuits and between these circuits and ground between open contact parts	2 kV (1 min) - 2.2 kV (1 s) 1 kV (1 min) - 1.1 kV (1 s)			2 kV (1 min) - 2.2 kV (1 s) 2 kV (1 min) - 2.1 kV (1 s)	
Impulse withstand voltage (1.2/50μs - 0.5J) between electrically independent circuits and between these circuits and ground between open contact parts	5 kV 3 kV			5 kV 5 kV	

Mechanical specifications	CLE	OKRe-L	OKRe-FP	TOK-L	TOK-FP
Mechanical life expectancy	20x10 ⁶ operations			100x10 ⁶ operations	
Degree of protection (with relay mounted)	IP40				
Dimensions (mm) ⁽¹⁾	40x45x97			45x45x109	
Weight (g)	~ 220			~ 300	

(1) Excluding output terminals and adjuster knob, if specified.

Environmental specifications	CLE	OKRe-L	OKRe-FP	TOK-L	TOK-FP
Operating temperature				-25 to + 55 °C	
Rolling stock version				-25 to + 70 °C	
Storage and transport temperature				-25 to + 85 °C	
Relative humidity	Standard: 75% RH, Tropicalized: 95% RH				
Resistance to vibrations	5 g - 10 to 55 Hz - 1min.		5 g - 5 to 60 Hz - 1 min.		
Resistance to shock	20 g - 11 ms		30 g - 11 ms		
Fire behavior	V0				

Standards and reference values

EN 61810-1, EN 61810-2, EN 61810-7	Electromechanical elementary relays
EN 61812-1	Timer relays
EN 60695-2-10	Fire behavior
EN 61000	Electromagnetic compatibility
EN 60529	Degree of protection provided by enclosures

Unless otherwise specified, products are designed and manufactured to the requirements of the European and International standards indicated above. In accordance with EN 61810-1, all items of technical data are referred to ambient temperature 23 °C, atmospheric pressure 96kPa and 50% humidity. Tolerance for coil resistance, nominal electrical input and nominal power is $\pm 7\%$.

Railways, rolling stock - Standards

EN 60077	Electric equipment for rolling stock - General service conditions and general rules
EN 50155	Electronic equipment used on rolling stock
EN 61373	Shock and vibration tests, Cat 1, Class B
EN 45545-2	Fire behavior, Cat E10, Requirement R26, V0
ASTM E162, E662	Fire behavior

Configurations - Options

P2	Tropicalization of coil with epoxy resin for use with 95% RH (@ T 50 °C). This treatment also protects the coil against corrosion which could occur by the combination of humidity with certain chemical agents, such as those found in acid atmospheres (typical of geothermal power stations) or saline atmospheres.
P4GEO	Gold plating of contacts with gold-nickel alloy, thickness $\geq 6\mu$. This treatment ensures long-term capacity of the contact to conduct lower currents in harsh ambient conditions such as acid atmospheres (typical of geothermal power stations) or saline atmospheres.
P5GEO	P4GEO type gold-plating, but applied to contacts, contact terminals and output terminals + P2 coil tropicalization.
P6GEO	Gold-plating of contacts, contact terminals and output terminals + P2 coil tropicalization.
P7	Silver cadmium oxide contacts.
P8	Gold plating of contacts with gold-cobalt alloy, thickness $\geq 5\mu$, knurled fixed contact. This finish allows further improvement of the performance provided by the gold-plated contact, compared to treatment P4GEO .
LED	LED indicator showing presence of power supply, wired in parallel with the coil.
FLYBACK DIODE	Polarized component connected in parallel with the coil (type 1N4007 or BYW56 for rolling stock version) designed to suppress overvoltages generated by the coil when de-energized.
TRANSIL	Non-polarized component connected in parallel with the coil. Behavior is similar to that of a varistor, with faster operating times.

CLE Ordering scheme

Function	Product code	Application ⁽¹⁾	Configuration A	Configuration B	Label	Type of power supply	Nominal voltage (V) ⁽²⁾	Keying position ⁽³⁾
Flasher	CLE	E: Energy Railway Fixed Equipment	1: Standard	0: Standard 2: P2 4: P4 GEO 5: P5 GEO 6: P6 GEO 7: P7 8: P8	F	C: Vdc A: Vac 50 Hz H: Vac 60 Hz	024 - 048 - 110 125 - 230	XXX
Example	CLE	E	1	0	F	H	125	
	CLEE10F-H125: CLE relay, ENERGY series, standard coil, nominal voltage 125Vac 60Hz							

OKRE-L / OKRE-FP Ordering scheme

Function	Product code	Application ⁽¹⁾	Configuration A	Configuration B	Label	Type of power supply	Nominal voltage (V) ⁽²⁾	Setting control ⁽³⁾	Full scale times ⁽³⁾	Keying position ⁽³⁾
Flasher	OKReL	E: Energy Railway Fixed Equipment	1: Standard 2: Diode // 3: Varistor 4: Led 5: Diode // + Led 6: Varistor + Led 7: Transil 8: Transil + Led	0: Standard 2: P2 4: P4 GEO 5: P5 GEO 6: P6 GEO 7: P7 8: P8	F	T: Vdc+ac C: Vdc ⁽⁴⁾	024 - 036 - 048 072 - 110 - 125 132 - 144 - 220 230	M = Knob C = Flat head slotted screw	01S: 1 s 05S: 5 s 10S: 10 s 15S: 15 s 30S: 30 s 01M: 1 min 02M: 2 min 05M: 5 min 10M: 10 min 15M: 15 min 30M: 30 min 60M: 60 min	xxx
One-shot	OKReFP	R: Railway Rolling Stock								
Example	OKReL	R	1	2	F	C	072	M	01S	
	OKReL12F-C072-M01S: OKRe-L relay, rolling stock series, P2 coil tropicalization, nominal voltage 72Vdc, full scale 1 second, knob setting control									
	OKReFP	E	4	8	F	T	110	C	05M	
OKReFP48F-C110-C05M: OKRe-FP relay, energy series, nominal voltage 110Vdc/ac, full scale 5 minutes, slotted screw setting control, with led, P8 finish (gold-plated contacts)										

TOK-L / TOK-FP Ordering scheme

Function	Product code	Application ⁽¹⁾	Configuration A	Configuration B	Label	Type of power supply	Nominal voltage (V) ⁽²⁾	Full scale times ⁽³⁾	Keying position ⁽³⁾	
Flasher	TOK-L	E: Energy / Railway Fixed Equipment	4: Led (fixed range)	0: Standard 2: P2 4: P4 GEO 5: P5 GEO 6: P6 GEO	F	C: Vdc ⁽⁴⁾ A: Vac 50 Hz H: Vac 60 Hz	024 - 036 - 048 072 - 110 - 125 132 - 144 - 220 230	01S: 1 s 02S: 2 s 04S: 4 s 08S: 8 s 16S: 16 s 32S: 32 s 01M: 1 min 02M: 2 min 04M: 4 min 08M: 8 min 16M: 16 min 32M: 32 min 64M: 64 min	xxx	
One-shot	TOK-FP	R: Railway Rolling Stock								
Example	TOK-L	R	4	0	F	C	072	64M		
	TOKLR40F-C072-64M: TOK-L relay, railways series, rolling stock, nominal voltage 72Vdc, full scale 64 minutes									
	TOK-FP	E	4	2	F	A	220	04S		
TOKFPE42F-A220-04S: TOK-FP relay, energy series, P2 coil tropicalization, nominal voltage 220Vac, full scale 4 seconds										

(1) E = ENERGY: all applications, except for railways rolling stock.
 Suitable on energy production, transport and distribution plants, railways fixed equipment, petrochemical and heavy industry.
 R = RAILWAYS, ROLLING STOCK: Application on board rolling stock (rail-tram-trolley vehicles). Electrical characteristics according to EN60077.
 Available also the product series:
 RAILWAYS, FIXED EQUIPMENT: Approved and conforming relays and products to RFI (FS Group) specification no. RFI DPRIM STF IFS TE 143 A
 For the list of RFI approved and conforming products, consult dedicated catalogue "RAILWAY SERIES - RFI APPROVED".
 STATIONS: ENEL approved material meeting LV15/LV16 specifications.
 For the list of ENEL approved and conforming products, consult the dedicated catalog "STATIONS SERIES - LV15-LV16-LV20". CLE: also available is the Stations series, with ENEL approved material meeting LV15/LV16 specifications. Consult the dedicated catalog for more information.

(2) Other values on request.
 (3) Optional value. The positive mechanical keying is applied according to the manufacturer's model.
 (4) Rolling Stock version, Vdc only available.

Wiring diagram

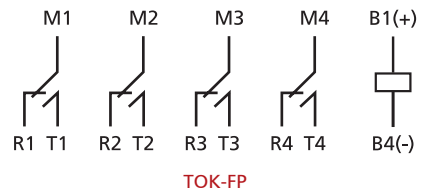
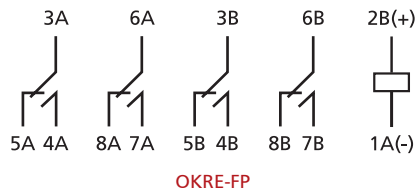
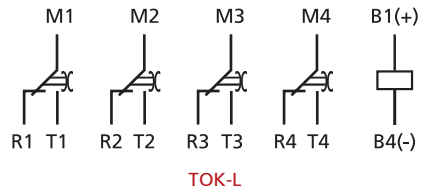
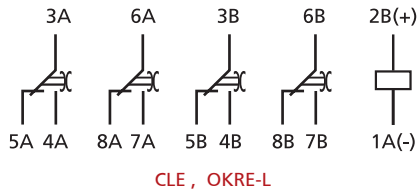

Functional diagram

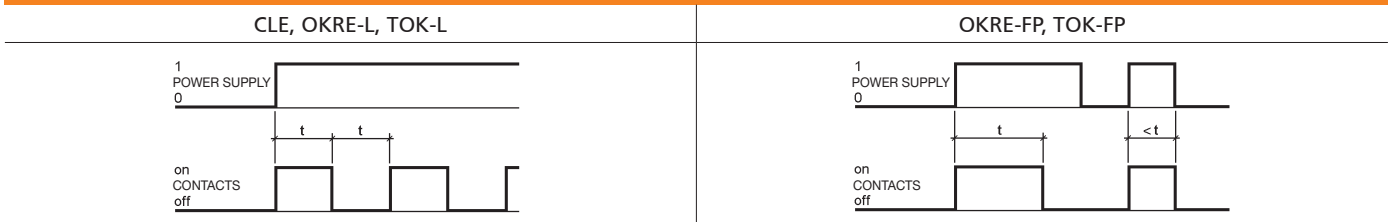

Time delay Switching time setting	OKRE-L OKRE-FP	TOK-L TOK-FP	CLE
Time setting	By way of potentiometer, with knob or flat head slotted screw control	By way of potentiometer, with flat head slotted screw control	No time setting 55 ... 90 pulse/min symmetrical
Full scale times available	10 ÷ 100 % of full scale	20 ÷ 100 % of full scale	
Time setting range	± 10 % of time delay	± 5 % of time delay	
Accuracy, setting (0.8...1,1 Un, t=20°C)	DC : 0.5 % / AC : ± 0.5 % + 20 ms	± 5% of time delay	
Accuracy, repeatability	DC: 0.5 % / AC : ± 0.5 % + 20 ms		
Reset	< 100ms, in time-delay phase < 1s		

Dimensions

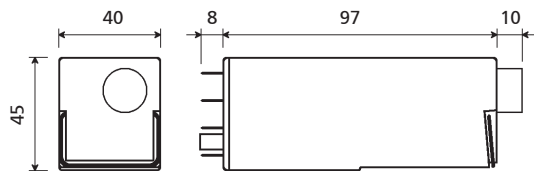

OKRE-L / OKRE-FP with knob setting control

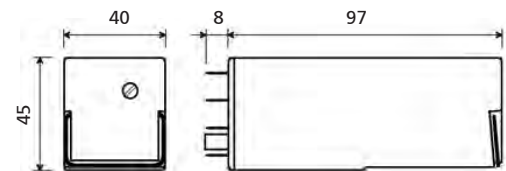

OKRE-L / OKRE-FP with flat head slotted screw setting control

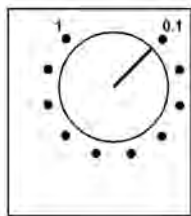

Knob setting control

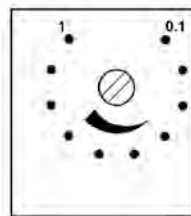

Flat head slotted screw setting control

The scale shown on the relay (0.1-1) is approximate

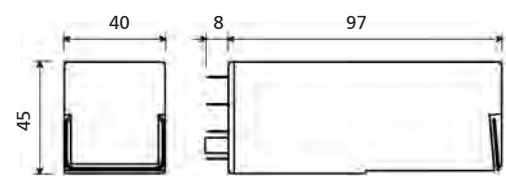

CLE

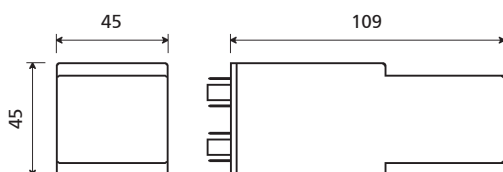

TOK-L / TOK-FP

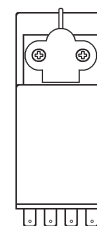

TOK-L / TOK-FP finish for ROLLING STOCK version

CLE OKRE-L OKRE-FP

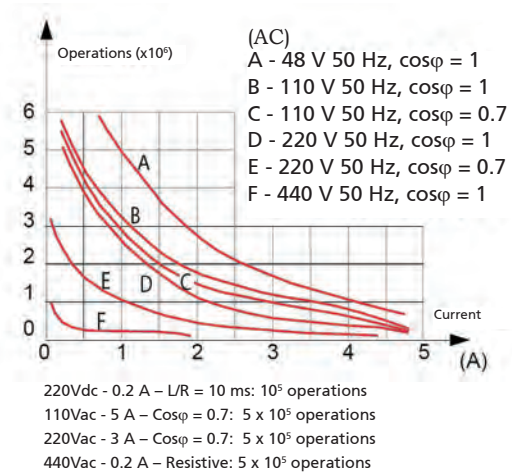
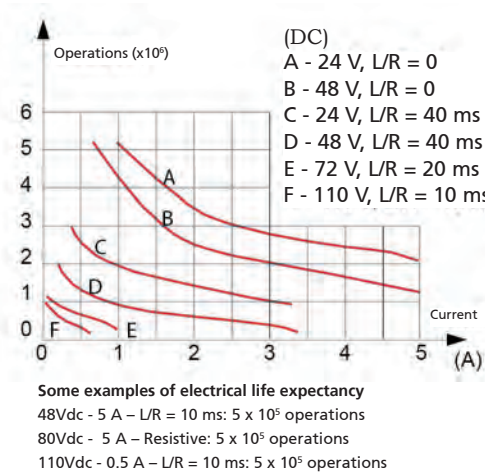

TOK-L TOK-FP

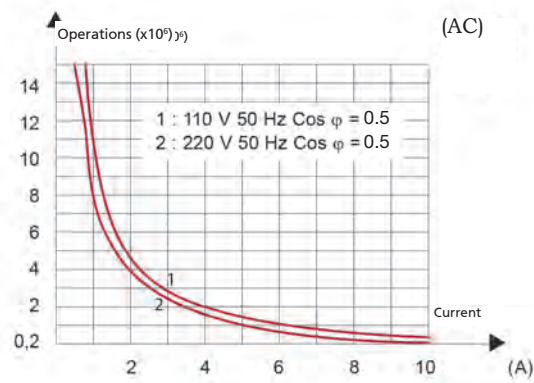
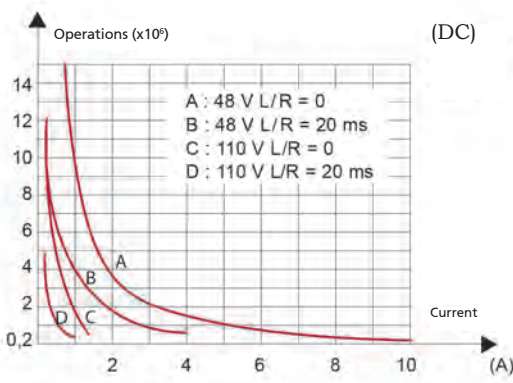

Other examples of electrical life expectancy available on the technical data sheet of the OK series relay (OKSFC model)

Sockets and retaining clips

		CLE OKRe-L OKRe-FP	TOK-L TOK-FP
Number of terminals (standard dimensions 5x0.8mm)	16	Retaining clip ⁽²⁾	
For wall or rail mounting			
Spring clamp, wall or DIN H35 rail mounting	PAIR160	RC48	RL48
Screw, wall or DIN H35 rail mounting	48BIP20-I DIN	RC48	RL48
Screw, wall mounting	48BL	RC48	RL48
Double faston, wall mounting	48L	RC48	RL48
For flush mounting			
Double faston (4.8 x 0.8 mm)	ADF2	RC48	RL48
Screw	43IL ⁽¹⁾	RC43	RL43
For mounting on PCB	65	RC43	RL43

(1) Insert the clip before fastening the socket on the panel.
 (2) Assume two clips for use on rolling stock.
 For more details, see specifications of mounting accessories.

Mounting tips

The preferred mounting position is on the wall, with the relay positioned horizontally in the reading direction on the nameplate. For correct use of the relays, they should be spaced apart by at least 5 mm in the horizontal direction and 20 mm in the vertical direction. This is to allow correct upward dissipation of the heat generated by the coil. Set these distances according to the socket used. Distances can be reduced depending on the environmental application conditions and on the relay duty cycle. For safe and secure operation, it is advisable to use retaining clips. No special maintenance is required. Condensation can form inside the relay when powered up and the outside ambient temperature is cold; this is quite normal and does not affect the operation of the relay. The plastic materials of the relay do not possess hygroscopic properties.

RELAYS

RELAYS

RELAYS

RELAYS

RELAYS

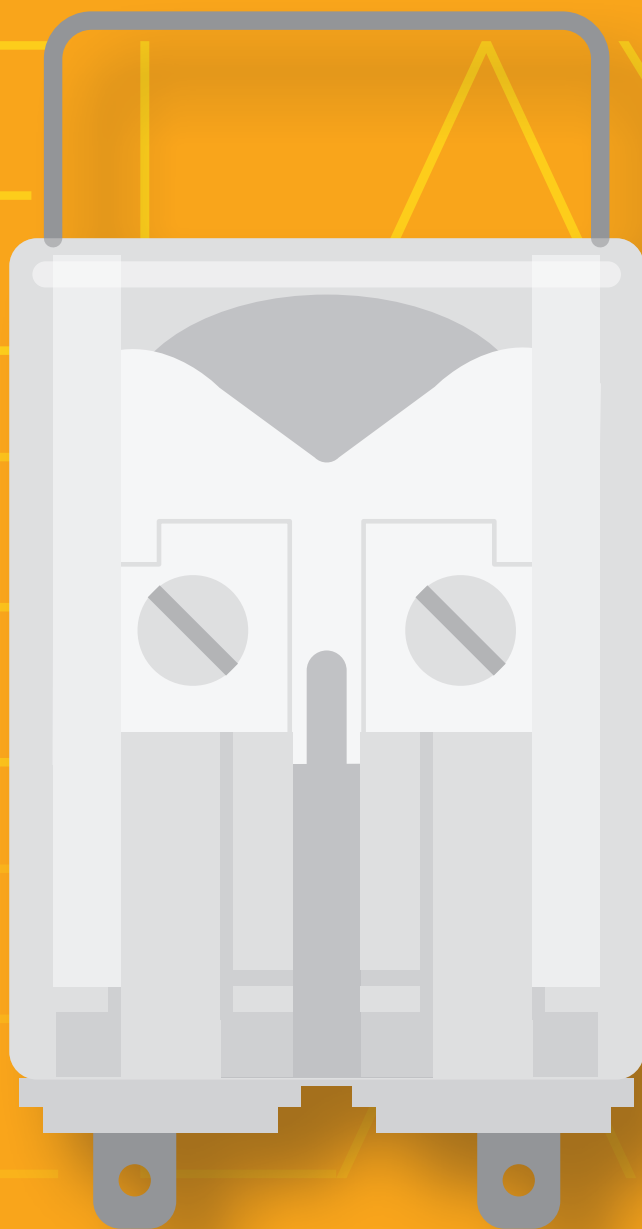

TIME RELAYS WITH FORCIBLY GUIDED CONTACTS

KEYING

RETAINING CLIPS

PCB MOUNT

BACK
CONNECTION

FRONT
CONNECTION

SOCKET
NUMBERING
EXPLANATIONS

MEASUREMENT

TIME DELAY WITH
FORCIBLY GUIDED
CONTACTS

TIME DELAY
(ON PICKUP
OR DROP-OUT)

FAST-ACTING
(MONOSTABLE
AND BISTABLE)

BISTABLE

INSTANTANEOUS
MONOSTABLE WITH
FORCIBLY GUIDED
CONTACTS

MONOSTABLE
INSTANTANEOUS



RELAYS

RGK SERIES with forcibly guided contacts

USER SECTORS



Power generation



Nuclear



Power transmission



Rolling Stock



Fixed railway installations



Shipbuilding



Petroleum industry



Heavy industry



RGK



PRODUCT ADVANTAGES

- Plug-in monostable timed relay, "pick-up" or "drop-out" function
- Forcibly guided (mechanically linked) contacts, relay compliant with EN 61810-3, tipo A
- Weld-no-transfer technology
- Wide time setting range from 0.1s to more than 16 hours, great accuracy over the entire adjustment range
- Suitable for safety applications
- Operation with d.c. and/or a.c. power supply
- Self-cleaning knurled contacts
- Magnetic arc blow-out for higher breaking capacity
- Led optical indicators monitoring power supply and timer status

DESCRIPTION

The relays in the **RGK series** are highly reliable products featuring high performance, suitable for applications in very harsh and disturbed environments. They are provided with forcibly guided (mechanically linked) contacts. The component conforms to the **EN 61810-3 requirements**, type A relay (all contacts are mechanically linked). Forcibly guided contacts are also known as weld-no-transfer contacts. A typical application is the check reading of a contact for determining, with absolute certainty, the state of the other contacts in self-monitoring control system. Timing is managed by high reliability electronic, made with professional components. The electronic is immune to strong EMC interference, typical of high voltage electricity distribution stations.

Switching times ranging from 0.1s to over 16 hours, providing extreme accuracy over the entire setting range. This is made possible by the fact that the relay offers intermediate scales, which the user can select by means of rotary switches. The timing function can be set in two modes: "pick-up" or "drop-out".

The types of contacts allow obtaining remarkable performance levels both for high, very inductive loads or very low loads; the presence of the magnetic arc blow-out contributes considerably to the breaking capacity. The **knurled contacts** ensure better self-cleaning characteristics and lower **ohmic resistance** thanks to the various points of

electrical connection, thereby **improving the electrical life expectancy of the component**.

In relays with forcibly guided (mechanically linked) or weld-no-transfer contacts, special design and constructional measures are used to ensure that make (normally-open) contacts can not assume the same state as break (normally-closed) contacts.

- If, when powering up a relay, a NC contact fails to open, the remaining NO contacts must not close, maintaining a contact gap ≥ 0.5 mm
- When the relay is de-energized, if a NO contact fails to open, the remaining NC contact must not close, maintaining a contact gap ≥ 0.5 mm

EN 61810-3 defines the requirements for relays with forcibly guided contacts. This standard defines two types of relay with forcibly guided contacts:

- Type A: Relay whose contacts are all mechanically linked (forcibly guided).
- Type B: Relay containing mechanically linked contacts and contacts which are not mechanically linked.

In the case of relays that include changeover contacts, either the make circuit or the break circuit of a changeover contact can be considered to meet the requirements of this standard.

Models	Number of contacts	Magnetic arc blow-out	Function
RGK.x7X	4	•	Pick-up / Drop-out

FOR CONFIGURATION OF PRODUCT CODE, SEE "ORDERING SCHEME" TABLE

Coil specifications	RGKE	RGKR
Nominal voltages Un	AC/DC: 24-36-48-72-96-110-125-230 ⁽¹⁾	
Consumption at Un (DC/AC)	3.5W	
Operating range	80...120% Un	70...125% Un
Type of duty	Continuous	
Drop-out voltage ⁽²⁾	> 5% Un	

(1) Other values on request.

(2) Limit value for supply voltage, expressed as % of the nominal value, beneath which the relay is certainly de-energized.

Contact specifications		
Number and type	4 CO, form C	
Current	Nominal ⁽¹⁾	12A
	Maximum peak ⁽²⁾	20A for 1min - 40A for 1s
	Maximum pulse ⁽²⁾	150A for 10ms
Example of electrical life expectancy ⁽³⁾	1A - 110Vdc - L/R 40 ms - 10 ⁵ operations - 1,800 operations/hour	
Minimum load	Standard contacts	200 mW (10 V, 10 mA)
	Gold-plated contact	50 mW (5 V, 5 mA)
Maximum breaking voltage	350 VDC / 440 VAC	
Contact material	AgCdO	
Operating time at Un (ms) ⁽⁴⁾	DC / AC	
	Pick-up (NC contact opening)	≤ 20
	Pick-up (NO contact closing)	≤ 35
	Drop-out (NO contact opening)	≤ 10
	Drop-out (NC contact closing)	≤ 53

(1) On all contacts simultaneously, reduction of 30%.

(2) The max. peak and pulse currents are those currents that can be handled, for a specified time, by the contact. They do not refer to steady or interrupted currents.

(3) For other examples, see electrical life expectancy curves.

(4) Unless specified otherwise, the operating time signifies until stabilization of the contact (including bounces).

Insulation		
Insulation resistance (at 500Vdc)	between electrically independent circuits and between these circuits and ground	> 10,000 MΩ
	between open contact parts	> 10,000 MΩ
Withstand voltage at industrial frequency	between electrically independent circuits and between these circuits and ground	2 kV (1 min) - 2.2 kV (1 s)
	between open contact parts	2 kV (1 min) - 2.2 kV (1 s)
	between adjacent contacts	2 kV (1 min) - 2.2 kV (1 s)
Impulse withstand voltage (1.2/50μs - 0.5J)	between electrically independent circuits and between these circuits and ground	5 kV
	between open contact parts	4 kV

Mechanical specifications		
Mechanical life expectancy	10x10 ⁶ operations	
Maximum switching rate	Mechanical	3,600 operations/h
Degree of protection	IP40	
Dimensions (mm)	45x50x112 ⁽¹⁾	
Weight (g)	300	

(1) Excluding output terminals

MONOSTABLE INSTANTANEOUS
INSTANTANEOUS MONOSTABLE WITH FORCIBLY GUIDED CONTACTS
BISTABLE
FAST-ACTING MONOSTABLE (AND BISTABLE)
TIME DELAY (ON PICK-UP OR DROP-OUT)
TIME DELAY WITH FORCIBLY GUIDED CONTACTS
MEASUREMENT
SOCKET NUMBERING EXPLANATIONS
FRONT CONNECTION
BACK CONNECTION
PCB MOUNT
RETAINING CLIPS



Environmental specifications

Operating temperature	Standard	-25 to 55°C
	Version for railways, rolling stock	-25 to 70°C
Storage and shipping temperature		-40 to 85°C
Relative humidity		Standard: 75% RH - Tropicalized: 95% RH
Fire behavior		V0



Standards and reference values

EN 61810-1, EN 61810-2, EN 61810-7, EN 61812	Electromechanical elementary relays
EN 61810-3, type A	Relays with forcibly guided (mechanically linked) contacts
EN 61812-1	Timer relays
EN 60695-2-10	Fire behavior
EN 60529	Degree of protection provided by enclosures
EN 61000	Electromagnetic compatibility

Unless otherwise specified, the products are designed and manufactured according to the requirements of the above-mentioned European and International standards. In accordance with EN 61810-1, all items of technical data are referred to ambient temperature 23 °C, atmospheric pressure 96kPa and 50% humidity. Tolerance for coil resistance, nominal electrical input and nominal power is $\pm 7\%$.



Railways, rolling stock - Standards

Applicable to RGKR version

EN 60077	Electric equipment for rolling stock - General service conditions and general rules
EN 50155	Electronic equipment used on rolling stock
EN 61373 ⁽¹⁾	Shock and vibration tests, Cat 1, Class B
EN 45545-2	Fire behavior, Cat E10, Requirement R26, V0
ASTM E162, E662	Fire behavior

(1) Permissible opening time of contacts on a de-energized relay $t < 3\text{ms}$.



Configurations - Options

TROPICALIZATION	Surface treatment of the coil with protective coating for use with RH 95%.
GOLD PLATING	Surface treatment of the contacts, blades and output terminals with gold-cobalt alloy $\geq 2\mu$. This treatment ensures long-term capacity of the contact to conduct lower currents.



Ordering scheme

Product code	Application ⁽¹⁾	Configuration A	Configuration B	Label	Type of power supply	Nominal voltage (V) ⁽²⁾	Finish ⁽³⁾
RGK	E: Energy R: Railway, Rolling Stock	1: Standard 4: Gold plating	7X: 4 CO contacts with magnetic arc blow-out	F	T: Vdc + Vac 50 Hz	024 - 036 - 048 072 - 096 - 110 125 - 230	T: Tropicalized coil

(1) **ENERGY**: all applications except for rolling stock applications.

RAILWAYS, ROLLING STOCK: application on board rolling stock (wire-rail-tramway vehicles). Electrical characteristics according to EN60077.

(2) Other values on request.

(3) Optional value.

Example	RGK	E	1	7X	F	T	048	T
	RGKE17XF-T048T = ENERGY series standard relay and 48Vdc tropicalized coil.							
	RGK	R	4	7X	F	T	110	
	RGKR47XF-T110 = ROLLING STOCK railway series relay, gold-plated contacts and 110Vdc coil.							

Wiring diagram

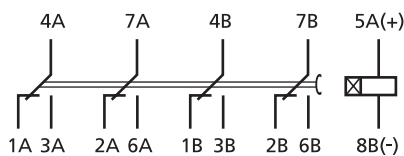

Pick-up diagram

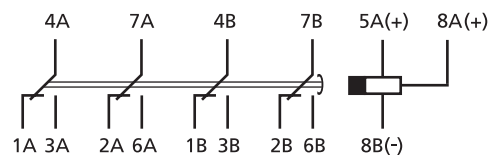

Drop-out diagram

Functional diagram

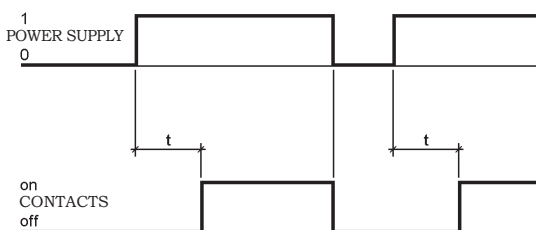

Pick-up delay

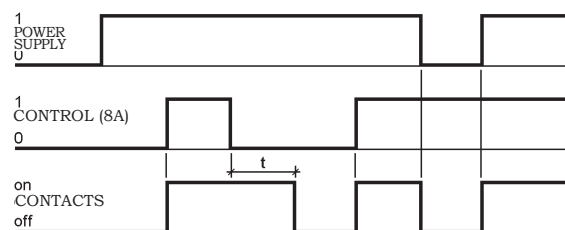

Drop-out delay



Time delay - Switching time setting

Time setting	By means of DIP switches and selectors
Time setting range	100 ms ... 990 min
Intermediate scales	6 (0.99 - 9.9 - 99 - 990 seconds / 99 - 990 minutes)
Resolution of switching time setting	1/100 of selected scale
Operating accuracy (0.8...1.1 Un, t=20°C) ⁽¹⁾	± 3 % at the beginning of scale - ±0.5 % at full scale time
Accuracy, repeatability	± 2 %
Reset	< 200 ms
Insensitivity to voltage drops	< 100 ms
Indication	Red led = presence of power supply Green led = status of relay outputs (lights up with relay energized)

(1) Additional error for drop-out versions: 100 ms

Time lag and function are set through a 4-bit DIP switch and two rotary selectors located on the front of the relay (see "FRONT"). These are accessible by removing the relay identification plate.

SETTINGS – Removing the plate

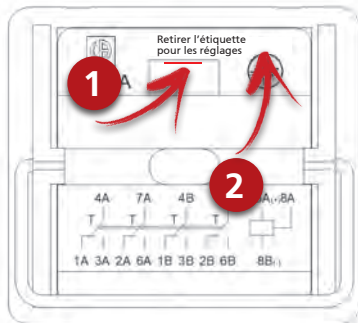
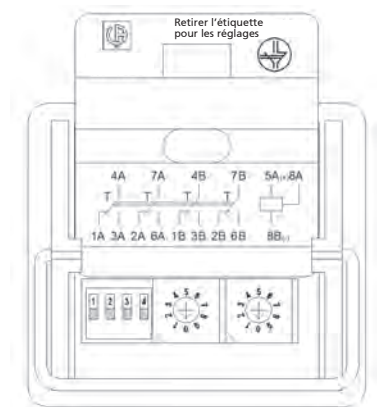

Plate is placed on the front of the cover.

To remove the plate:

1. Slightly lift the plate, by acting on the point shown in picture
2. Push upwards the plate.



SETTINGS – Time lag and function

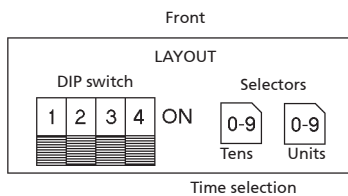

1-2-3 = select scale
4 = select function
OFF = Pick-up
ON = Drop-out

Scales / Setting range			Switch position		
Min	Max	Unit of measure	1	2	3
10	99	Hundredths (0.01s)	OFF	ON	OFF
1	99	Tenths (0.1s)	OFF	ON	ON
1	99	Seconds	ON	OFF	OFF
1	99	Seconds x 10	ON	OFF	ON
1	99	Minutes	ON	ON	OFF
1	99	Minutes x 10	ON	ON	ON

Table 1

Function : acts on DIP switch no. 4.

- OFF: Pick-up function
- ON: Drop-out function

Time lag :

Settings are possible from 100 ms up to 990 minutes.

1. Selects the RANGE: acts on DIP switch no. 1, 2, 3.
2. Selects the TIME LAG: acts on rotary selectors

Selects the RANGE: 6 ranges are available. Move DIP switches 1, 2, 3 to "ON" or "OFF" position to obtain the desired range, as shown in TABLE 1. The range should be the next higher than the value of the required time lag. E.g. Time lag: 1'14" = 74 seconds. Closest range: 99 seconds.

Selects the TIME LAG: time lag could be set by step of 1% of the selected range. Move rotary selectors to obtain the desired time. E.g. Time lag: 1'14" = 74 seconds. "TENS" selector on "7" + "UNIT" selector on "4".

Dimensions

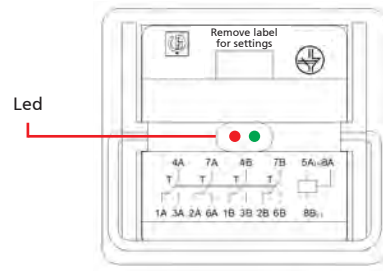
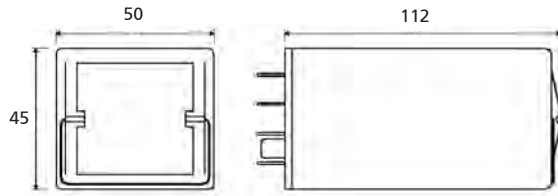

Electrical life expectancy

Some examples of electrical life expectancy

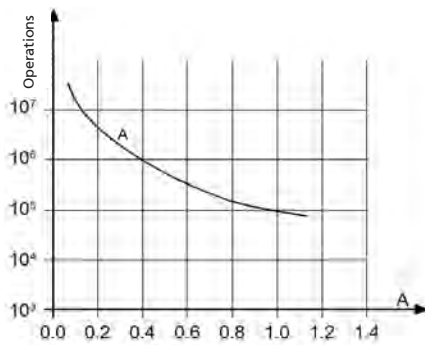

Contact loading: 110Vdc, L/R 40 ms

RGK.x7X			
U	I (A)	L/R (ms)	Operations
24 Vdc	1	0	7,000,000
24 Vdc	1	40	3,000,000
24 Vdc	2	40	2,000,000
24 Vdc	5	0	3,000,000
24 Vdc	5	40	200,000
24 Vdc	9	0	800,000
48 Vdc	5	20	200,000
110Vdc	0.4	40	1,000,000
110 Vdc	1	40	100,000
110 Vdc	10	0	100,000
U	I (A)	cosφ	Operations
220 Vac	5	0.5	100,000
220 Vac	10	1	100,000
230 Vac	1	0.7	2,500,000
230 Vac	3	0.7	1,200,000

Sockets and retaining clips

Type of installation	Type of outputs	Model	Retaining clip
Wall or DIN rail mounting	Screw	48BIP20-I DIN	RGL48
	Spring clamp	PAIR160	
Flush mounting	Spring clamp	PRIR160	RGL48
	Double faston (4.8 × 0.8 mm)	ADF2	

Mounting tips

The preferred mounting position is on the wall, with the relay positioned horizontally in the reading direction on the nameplate. For correct use of the relays, they should be spaced apart by at least 5 mm in the horizontal direction and 20 mm in the vertical direction. This is to allow correct upward dissipation of the heat generated by the coil. Set these distances according to the socket used. Distances can be reduced depending on the environmental application conditions and on the relay duty cycle.

For maximum reliability in operation, it is advisable to use retaining clips.

No special maintenance is required.

Condensation can form inside the relay when powered up and the outside ambient temperature is cold; this is quite normal and does not affect the operation of the relay. The plastic materials of the relay do not possess hygroscopic properties.

RELAYS

RELAYS

RELAYS

RELAYS

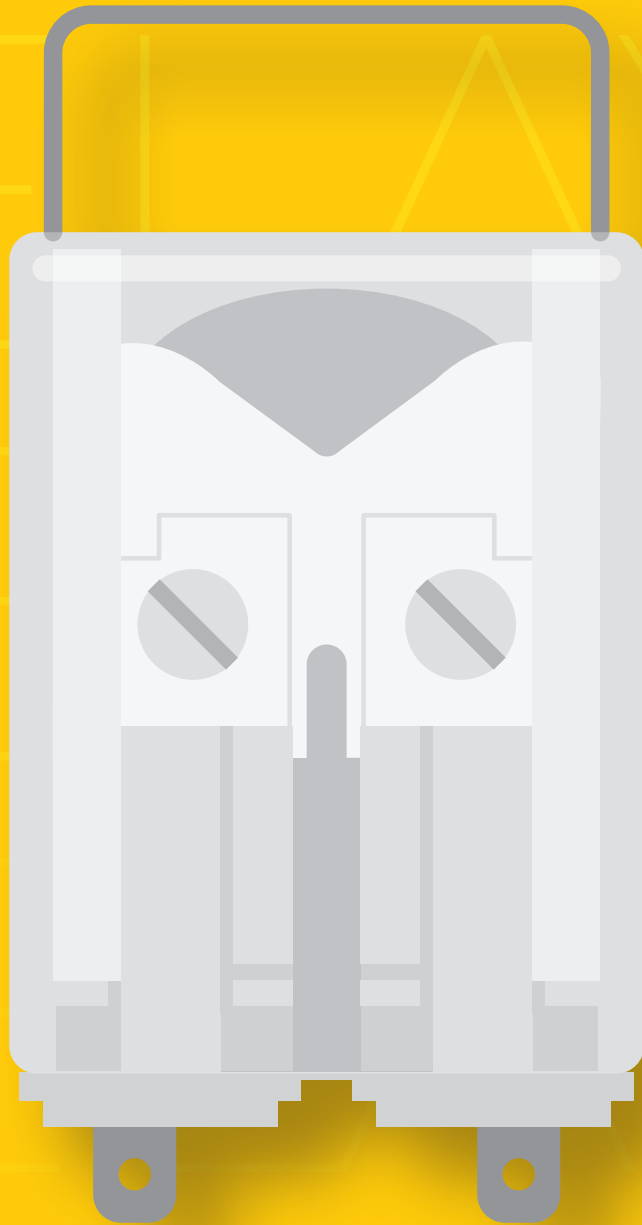

MEASURING RELAYS

KEYING

RETAINING CLIPS

PCB MOUNT

BACK CONNECTION

FRONT CONNECTION

SOCKET NUMBERING EXPLANATIONS

MEASUREMENT

TIME DELAY WITH FORCIBLY GUIDED CONTACTS

TIME DELAY (ON PICKUP OR DROP-OUT)

FAST-ACTING (MONOSTABLE AND BISTABLE)

BISTABLE

INSTANTANEOUS MONOSTABLE WITH FORCIBLY GUIDED CONTACTS

MONOSTABLE INSTANTANEOUS



RELAYS

MEASURING RELAYS

MOK-V2 SERIES

USER SECTORS



Power generation



Nuclear



Power transmission



Rolling Stock



Fixed railway installations



Shipbuilding



Petroleum industry



Heavy industry



MOK-V2

PRODUCT ADVANTAGES

- MOK-V2 voltage threshold relay
- Pick-up and drop-out thresholds adjustable by way of two independent potentiometers
- Electronic circuit requiring no auxiliary power supply
- Solid and rugged construction for heavy or intensive duty
- Long life expectancy
- Excellent shock and vibration resistance
- Wide range of sockets
- Retaining clip for secure locking of relay on socket
- Positive mechanical keying for relay and socket

DESCRIPTION

The products in the **MOK series** are measuring relays with adjustable hysteresis. The device measures an electrical quantity (voltage or current, depending on the model) registering in a monitored circuit; the contacts switch to 'make' status when this same quantity exceeds the pick-up threshold, selected by the user and expressed as a percentage of the nominal voltage/current.

The relay reverts to 'break' status when the measured quantity drops below the drop-out threshold (also selected by the user), expressed as a percentage of the pick-up threshold. **These models are suitable for the supervision and protection of electrical equipment used in the most demanding of sectors such as**, for example, electricity generating stations, electrical transformer stations, industries using continuous production processes, and railways - fixed equipment and rolling stock alike.

MOK-V2 voltage threshold relay

The MOK-V2 is a measuring relay with two adjustable voltage thresholds: Pick-up voltage and Drop-out voltage. The setting, which is made by way of the potentiometers located on the top of the relay, pilots an electronic circuit that does not require an auxiliary power supply. The PICK-UP VOLTAGE can be set at between 60% and 120% of nominal voltage. The DROP-OUT VOLTAGE can be set at between 70% and 98% of the pick-up voltage. The MOK-V2 model is equipped with two change-over contacts rated 8A. In the case of the direct current version, the relay is equipped with a polarization diode that protects the circuits against an accidental inversion of polarities. Particularly suitable for monitoring battery voltages in the rail-tram-trolley vehicles sector.

Models	Function	Threshold setting		Number of contacts	Rolling stock application
		Pick-up	Drop-out		
MOK-V2	Voltage threshold relay	•	•	2	•

FOR CONFIGURATION OF PRODUCT CODE, SEE "ORDERING SCHEME" TABLE

Coil specifications	
Nominal voltages Un	DC: 24-48-36-72-110-125-132-144-220 AC: 24-48-110-125-220 ⁽¹⁾
Max. consumption at Un (DC/AC)	3.5 W / 4 VA
Maximum operating range	130% Un for 1 min.
Type of duty	Continuous

(1) Other values on request.

Operating thresholds	
Setting	By potentiometer, with flat head slotted screw
Selectable ranges	-
Pick-up threshold	$V(i) = 60\% - 120\% U_n$
Drop-out threshold	$V(r) 70\% - 98\% V(i)$
Accuracy, setting (t=20°C)	$\pm 1.5\% U_n$
Additional error (-40°C, +70°C)	+1% Un
Accuracy, repeatability	1%

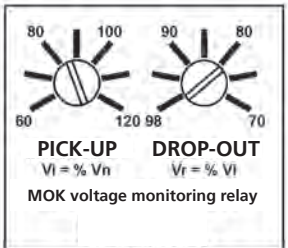
Front	
-------	---

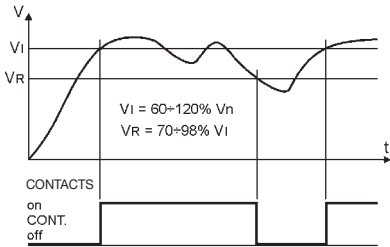
Functional diagram	
--------------------	--

Important: the drop-out voltage Vr is expressed as a percentage of the pick-up thresholds.

Contact specifications	
Number and type	2 CO, form C
Current Nominal ⁽¹⁾	8 A
Example of electrical life expectancy ⁽²⁾	8 A – 250 Vac – $\cos\phi = 1$: 10^5 operations 0.2 A – 110 Vdc – L/R = 40 ms : 10^5 operations
Minimum load	100 mW (10 V, 5 mA)
Maximum breaking voltage	150 Vdc / 400 Vac
Contact material	AgSnO
Operating time at Un (ms)	Pick-up (NO contact closing): ≤ 100 ms Drop-out (NC contact closing): ≤ 30 ms

(1) Nominal current: on all contacts simultaneously.

(2) 450 operations/hour.

MONOSTABLE INSTANTANEOUS
INSTANTANEOUS MONOSTABLE WITH FORCIBLY GUIDED CONTACTS
BISTABLE
FAST-ACTING MONOSTABLE (AND BISTABLE)
TIME DELAY (ON PICK-UP OR DROP-OUT)
TIME DELAY WITH FORCIBLY GUIDED CONTACTS
MEASUREMENT
SOCKET NUMBERING EXPLANATIONS
FRONT CONNECTION
BACK CONNECTION
PCB MOUNT
RETAINING CLIPS



Insulation

Insulation resistance (at 500Vdc) between electrically independent circuits and between these circuits and ground between open contact parts	> 1,000 MΩ > 1,000 MΩ
Withstand voltage at industrial frequency between electrically independent circuits and between these circuits and ground between open contact parts	2 kV (1 min) - 2.2 kV (1 s) 1 kV (1 min) - 1.1 kV (1 s)
Impulse withstand voltage (1.2/50µs - 0.5J) between electrically independent circuits and between these circuits and ground between open contact parts	5 kV 3 kV



Mechanical specifications

Mechanical life expectancy	10x10 ⁶ operations
Degree of protection (with relay mounted)	IP40
Dimensions (mm) ⁽¹⁾	48x48x118.5
Weight (g)	~ 180

(1) Excluding output terminals and adjuster knob, if specified.



Environmental specifications

Operating temperature	Rolling stock version	-25 to +55 °C
Storage and shipping temperature		-25 to +70 °C
Relative humidity		-50 to +85 °C
Resistance to vibrations		Standard: 75% RH, Tropicalized: 95% RH
Resistance to shock		5g - 10 to 55 Hz - 1min.
Fire behavior		20g - 11ms
		V0 - to EN 60695-2-10



Standards and reference values

EN 61810-1, EN 61810-2, EN 61810-7 EN 60695-2-10 EN 61000 EN 60529	Electromechanical elementary relays Fire behavior Electromagnetic compatibility Degree of protection provided by enclosures
---	--

Unless otherwise specified, the products are designed and manufactured according to the requirements of the above-mentioned European and International standards.
In accordance with EN 61810-1, all items of technical data are referred to ambient temperature 23 °C, atmospheric pressure 96kPa and 50% humidity.



Railways, rolling stock - Standards

EN 60077 EN 50155 EN 61373 EN 45545-2 ASTM E162, E662	Electric equipment for rolling stock - General service conditions and general rules Electronic equipment used on rolling stock Shock and vibration tests, Cat 1, Class B Fire behavior, Cat E10, Requirement R26, V0 Fire behavior
---	--



Configurations - Options

P2	Tropicalization of coil with epoxy resin for use with 95% RH (@ T 50 °C). This treatment also protects the coil against corrosion which could occur by the combination of humidity with certain chemical agents, such as those found in acid or saline atmospheres.
LOW TEMPERATURE	Minimum operating temperature -40 °C, only for the "rolling stock" version ("L" option).

Wiring diagram

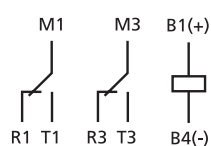

Selection of the range is made by connecting to the respective terminal.



MOK-x2 Ordering scheme

Product code	Application ⁽¹⁾	Configuration A	Configuration B	Label	Type of power supply	Nominal voltage (V) ⁽²⁾	Keying position ⁽³⁾ / Options
MOK-V2	E: Energy Railway Fixed Equipment R: Railway Rolling Stock	1: Standard (fixed range)	0: Standard 2: P2	F	C: Vdc ⁽⁴⁾ A: Vac 50 Hz	024 - 036 - 048 072 - 110 - 125 128 - 132 - 144 220 - 230	XXX L = low temperature

Example

MOKV2	R	1	2	F	C	024	
MOKV2R12F-C024 - MOK-V2 relay, ROLLING STOCK series, 24Vdc coil, with P2 coil tropicalization							

(1) **E = ENERGY:** all applications, except for railways rolling stock.

Suitable on energy production, transport and distribution plants, railways fixed equipment, petrolchemical and heavy industry.

R = RAILWAYS, ROLLING STOCK: Application on board rolling stock (rail-tram-trolley vehicles). Electrical characteristics according to EN60077.

(2) Other values on request.

(3) Optional value. The positive mechanical keying is applied according to the manufacturer's model.

(4) Railways and Rolling Stock version, Vdc only available.

Dimensions

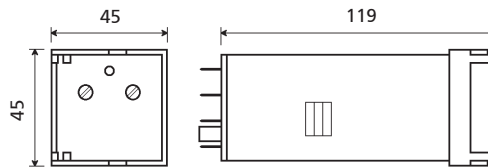

Sockets and retaining clips

Number of terminals (standard dimensions 5x0.8mm)	16	Retaining clip ⁽²⁾
For wall or rail mounting		
Spring clamp, wall or DIN H35 rail mounting	PAIR160	RM48
Screw, wall or DIN H35 rail mounting	48BIP20-I DIN	RM48
Screw, wall mounting	48BL	RM48
Double faston, wall mounting	48L	RM48
For flush mounting		
Double faston (4.8 x 0.8 mm)	ADF2	RM48
Screw	43IL ⁽¹⁾	RM43
For mounting on PCB	65	RM43

(1) Insert the clip before fastening the socket on the panel.

(2) Assume two clips for use on rolling stock.

For more details, see specifications of mounting accessories.

Mounting tips

The preferred mounting position is on the wall, with the relay positioned horizontally in the reading direction on the nameplate.

For correct use of the relays, they should be spaced apart by at least 5 mm in the horizontal direction and 20 mm in the vertical direction. This is to allow correct upward dissipation of the heat generated by the coil. Set these distances according to the socket used.

Distances can be reduced depending on the environmental application conditions and on the relay duty cycle.

For safe and secure operation, it is advisable to use retaining clips.

No special maintenance is required.

Condensation can form inside the relay when powered up and the outside ambient temperature is cold; this is quite normal and does not affect the operation of the relay. The plastic materials of the relay do not possess hygroscopic properties.

SOCKETS

SOCKETS

SOCKETS

SOCKETS

SOCKETS



SOCKETS

EXPLANATION OF SOCKET NUMBERING	P. 192
FRONT CONNECTION	P. 194
FRONT CONNECTION WITH SPRING CLAMP.....	P. 194
FRONT CONNECTION WITH SCREW.....	P. 196
FRONT CONNECTION WITH SINGLE FASTON	P. 205
REAR CONNECTION	P. 206
REAR CONNECTION WITH SPRING CLAMP	P. 206
REAR CONNECTION WITH SCREW	P. 210
REAR CONNECTION WITH SINGLE FASTON.....	P. 217
REAR CONNECTION WITH DOUBLE FASTON.....	P. 218
REAR CONNECTION WITH BLADE.....	P. 226
REAR CONNECTION WITH DOUBLE BLADE	P. 227
MOUNTING ON PCB	P. 228

NUMBERING CORRESPONDENCE BETWEEN RELAYS AND SOCKETS

- The relays in the "ENERGY" and "RAILWAY Rolling Stock" series have 2 types of numbering.

Specifications	Specifications Models	Example
OK numbering	OK, OKS, OKFC, OKSFC, OKSCD, OKSGcCd, OKUIC, OKBA, TOK, OKPh, MOK, UTM	
POK numbering	POK/POKS, BIPOK/BIPOKS, TRIPOK/TRIPOKS, TM, OKT, OKR, RCG, RDG, RGG	

QUADRIPOKS and ESAPOKS models are identified by international numbering.

- Sockets with more than 8 terminals carry both types of numbering (with the exception of the ADF series).

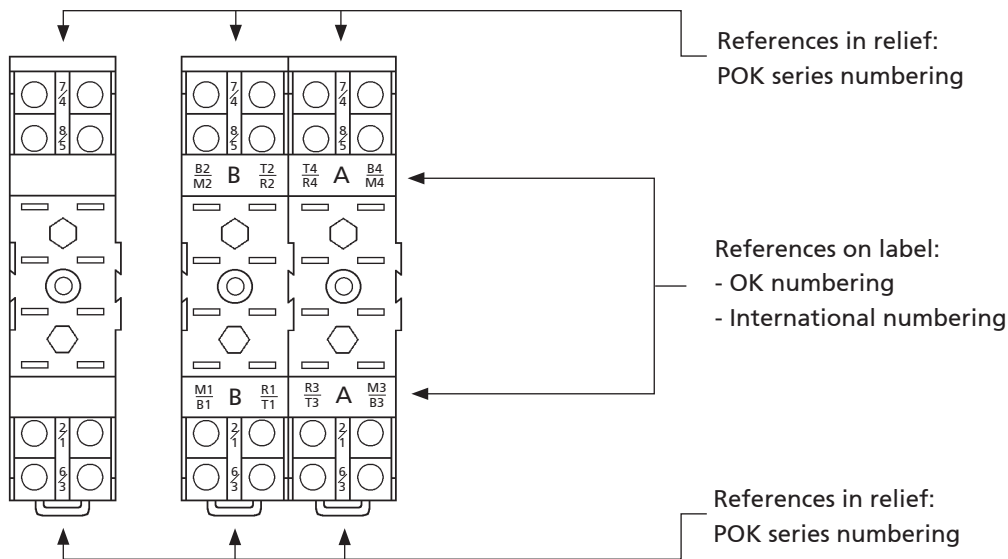

EXAMPLE OF "OK NUMBERING"

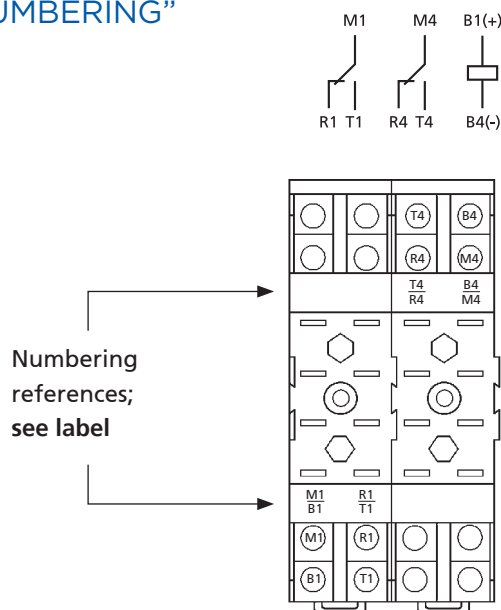

EXAMPLE OF "POK NUMBERING"

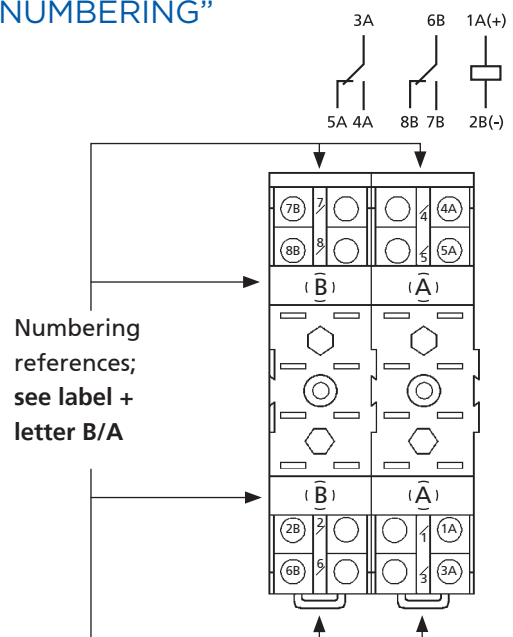



SOCKETS

FRONT CONNECTION (WITH SPRING CLAMP)

PAIR080 | PAIR160 | PAIR240 | PAIR320 | PAIR480

CONNECTION
FRONT

TERMINAL TYPE
SPRING CLAMP

MOUNTING
PANEL / DIN RAIL

PRODUCT ADVANTAGES

- Cable secured with spring clamp mechanism
- Insertion of lug with no need for tools
- Quick and easy wiring, saving more than half the time taken with conventional wiring
- Mounting to panel and 35mm DIN rail
- Excellent contact pressure on relay terminals
- Sturdy construction, no internal soldering
- Compatible with cable up to 2.5mm², bare (flexible or rigid) and with lug; 2 inputs per terminal
- Provision for fitment of keying pins
- Provision for fitment of retaining clip
- Protection IP20

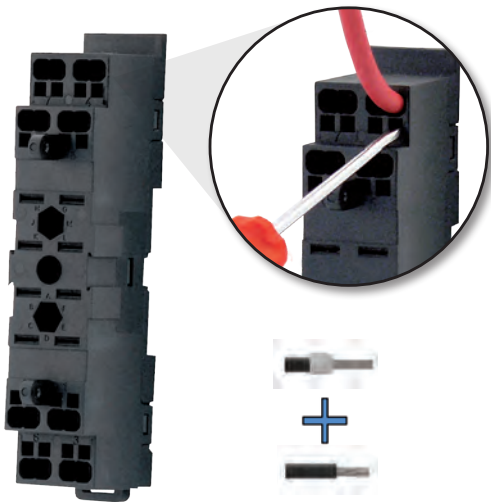

PAIR080

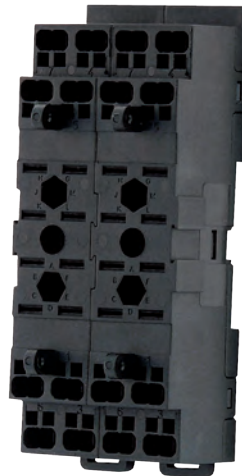

PAIR160

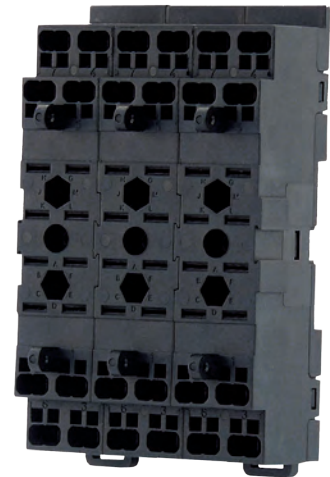

PAIR240

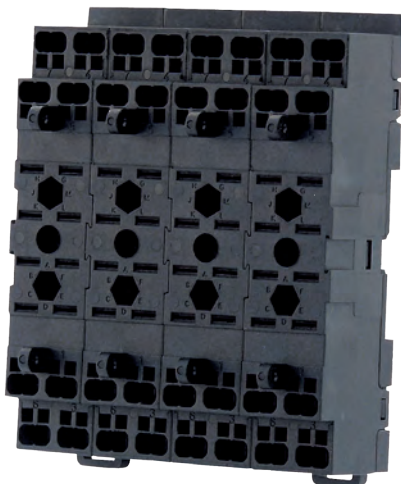

PAIR320

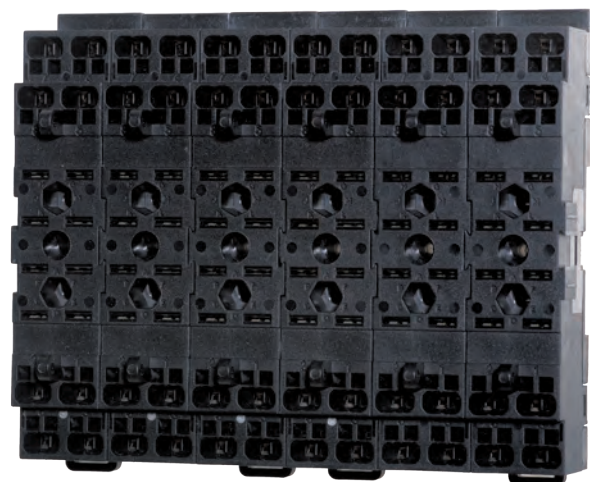

PAIR480

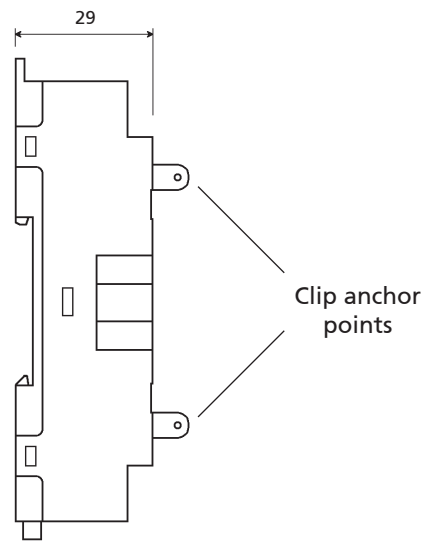
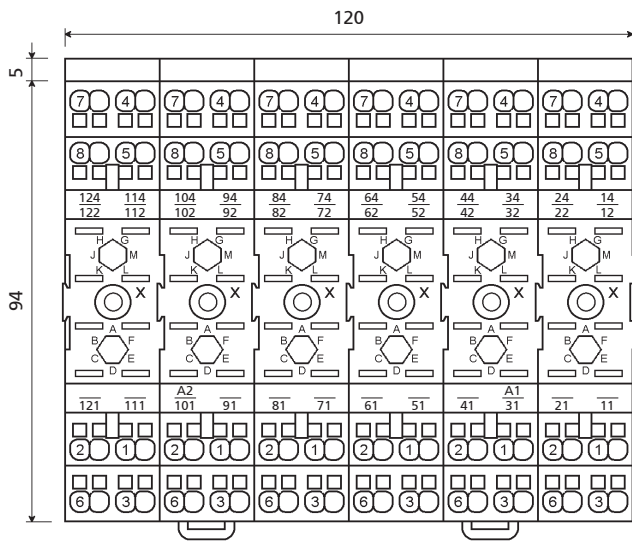
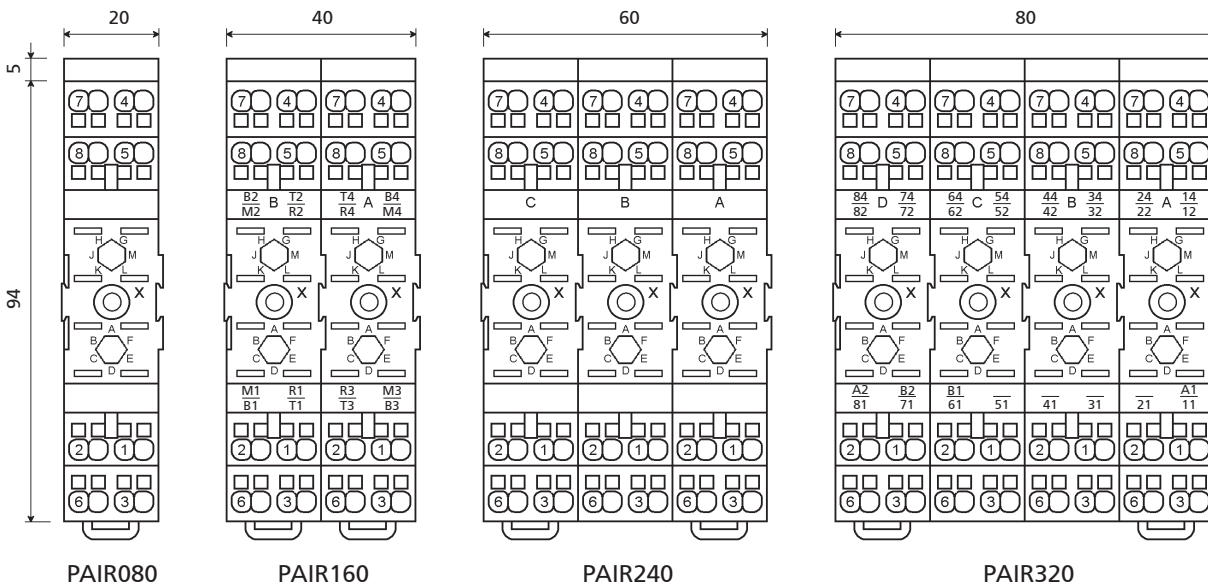

X = Fixing holes

PAIR480

Side view

SPECIFICATIONS

Weight: 62 / 124 / 186 / 248 / 370 g

Operating temperature: -50 °C...+70 °C

Storage temperature: -50 °C...+85 °C

Panel mounting: • \varnothing holes: 3.2 mm

- center distance between adjacent holes: 20 mm

Mounting to Omega support: H35 selon normes DIN 46277/3 - EN 60715

Degree of protection: IP20

Dielectric strength: 2.5 kV 50 Hz 1 min

Fire resistance: EN60695-2-1, UL94 - V0, EN45545-2, NFPA130

Standards: EN60255, EN60947, EN 61810, EN61373

Terminal type: spring clamp

Inputs for each relay terminal: 2

Minimum section of cable: • cable without lug: 1 mm²

- cable with lug: 0.5 mm²

Maximum section of cable: 2.5 mm²

Wire stripping length, mm: 10 mm \pm 0.5 mm

Length of lug: 12 mm

Wiring with rigid cables or lug: pressure grip

Wiring with flexible cables, extraction of cables: using screwdriver type tool with slim shaft and slotted head measuring 2.5mm x 0.4mm, inserted perpendicularly to the socket.

To order

PAIR080	P01 4003 55
PAIR160	P01 4003 56
PAIR240	P01 4003 57
PAIR320	P01 4003 58
PAIR480	P01 4003 64

MONOSTABLE INSTANTANEOUS
 INSTANTANEOUS MONOSTABLE WITH FORCIBLY GUIDED CONTACTS
 BISTABLE
 FAST-ACTING MONOSTABLE (AND BISTABLE)
 TIME DELAY (ON PICK-UP OR DROP-OUT)
 TIME DELAY WITH FORCIBLY GUIDED CONTACTS
 MEASUREMENT
 SOCKET NUMBERING EXPLANATIONS
 FRONT CONNECTION
 FRONT CONNECTION
 BACK CONNECTION
 PCB MOUNT
 RETAINING CLIPS



SOCKETS

FRONT CONNECTION (WITH SCREW)

50IP20-I DIN | 48BIP20-I DIN | 78BIP20-I DIN | 96IP20-I DIN | 156IP20-I DIN

CONNECTION	TERMINAL TYPE	MOUNTING
FRONT	SCREW	PANEL / DIN RAIL

PRODUCT ADVANTAGES

- Cable secured with screws
- Mounting to panel and 35mm DIN rail
- Sturdy construction
- Excellent contact pressure on relay terminals
- No internal soldering
- Inputs for maximum section 2.5 mm²
- Provision for fitment of keying pins
- Provision for fitment of retaining clip
- Protection IP20



50IP20-I DIN



48BIP20-I DIN



78BIP20-I DIN

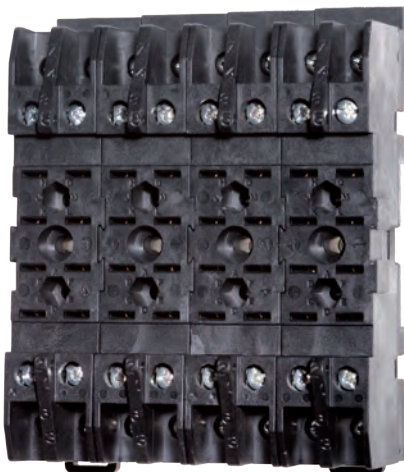

96IP20-I DIN



156IP20-I DIN

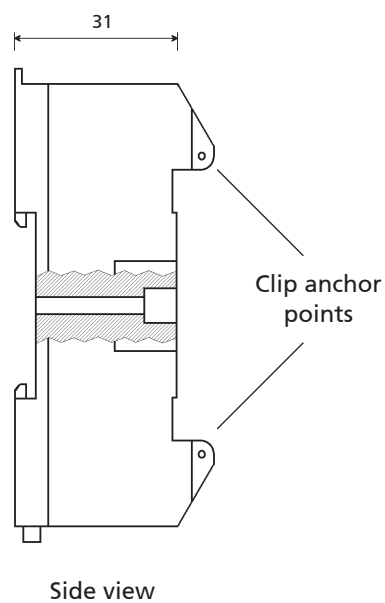
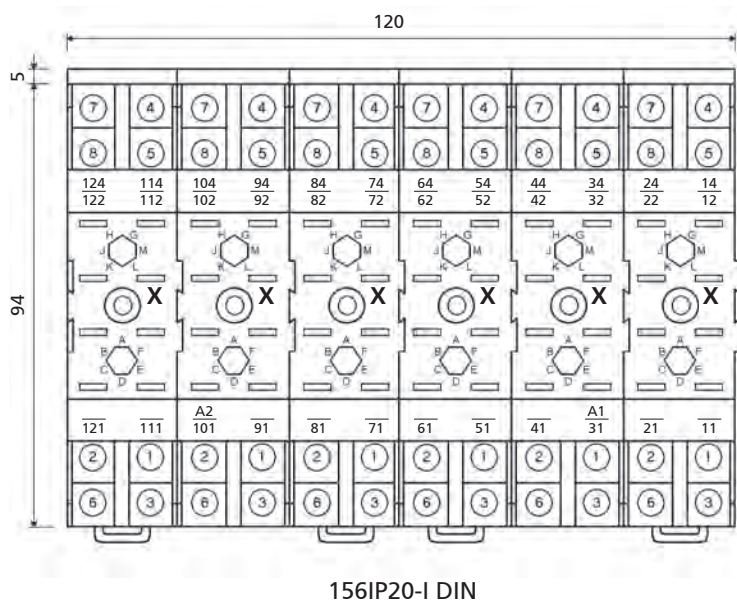
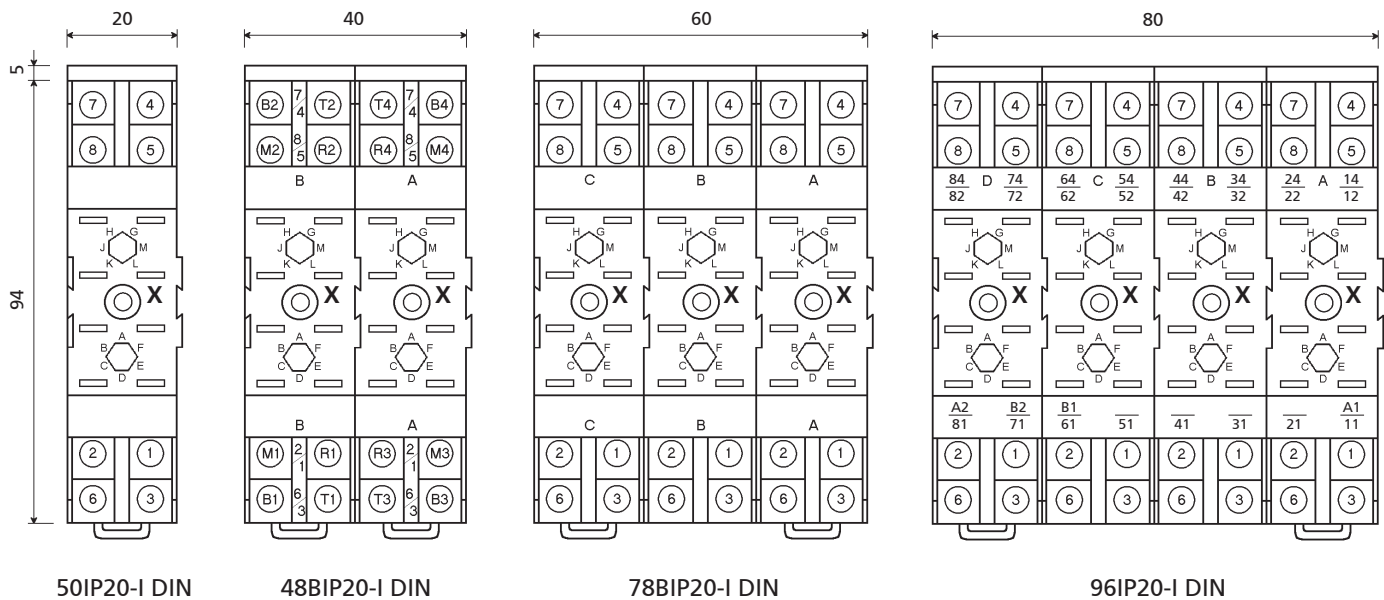

X = Fixing holes

SPECIFICATIONS

Weight: 70 / 140 / 210 / 280 / 415 g

Operating temperature: -50 °C...+70 °C

Storage temperature: -50 °C...+85 °C

Panel mounting:

- \varnothing holes: 4.2mm
- center distance between adjacent holes: 20mm

Degree of protection: IP20

Dielectric strength: 2,5 kV 50 Hz 1 min

Mounting to Omega support: H35 to DIN 46277/3 - EN 60715 standards

Type and size of screw: M3 thread, cross head

Tightening torque: 0.5 ... 0.6 Nm

Width of slot: 6.9 mm

Maximum section of cable: 2 x 2.5 mm²

Fire resistance: EN 60695-2-1, UL94 - V0, EN 45545-2, NFPA130

Standards: EN 60255, EN 60947, EN 61810, EN 61373

To order

50IP20-I DIN	P01 4002 33
48IP20-I DIN	P01 4002 34
78IP20-I DIN	P01 4002 35
96IP20-I DIN	P01 4002 36
156IP20-I DIN	P01 4002 37

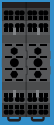

FRONT CONNECTION (WITH SCREW)

SOCKETS

50L | 48BL | 78BL | 96BL

CONNECTION	TERMINAL TYPE	MOUNTING
FRONT	SCREW	PANEL

PRODUCT ADVANTAGES

- Cable secured with removable screws
- Panel mounting
- Sturdy construction
- Excellent contact pressure on relay terminals
- No internal soldering
- Inputs for maximum section 2.5 mm²
- Provision for fitment of keying pins
- Provision for fitment of retaining clip
- Protection IP10



50L

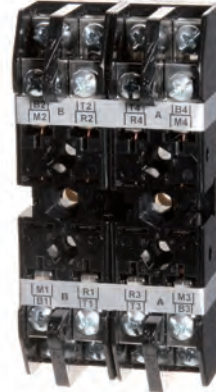

48BL



78BL

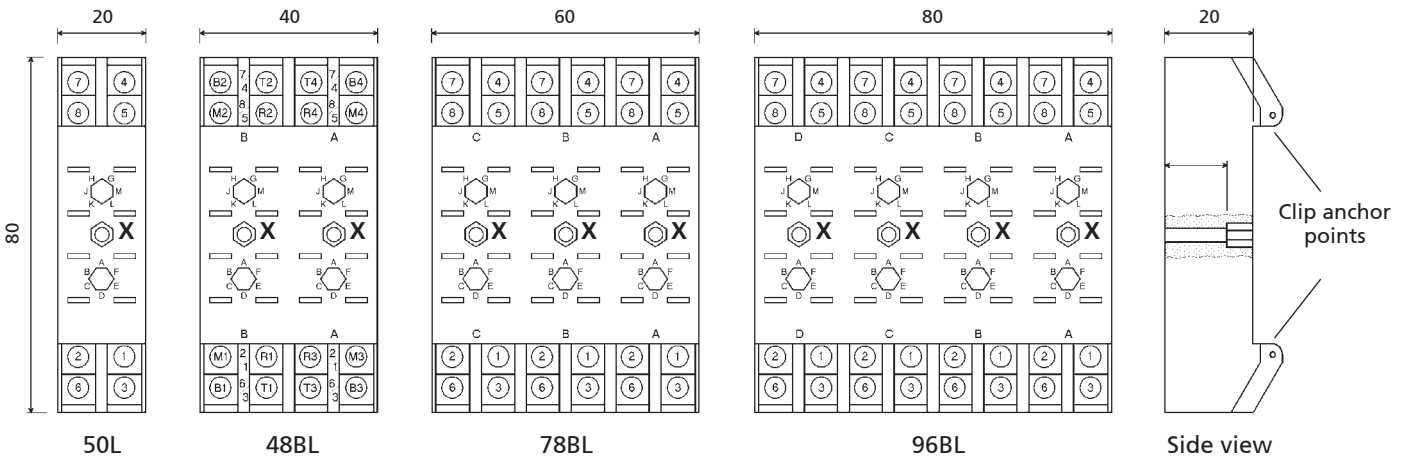

X = Fixing holes

SPECIFICATIONS

- Weight: 36 / 72 / 108 / 144 g
- Operating temperature: -25 °C...+70 °C
- Storage temperature: -40 °C...+85 °C
- Panel mounting:
 - ø holes: 4.2mm
 - center distance between adjacent holes: 20mm
- Degree of protection: IP10
- Dielectric strength: 2,5 kV 50 Hz 1 min
- Type and size of screw: M3 thread, cross head
- Removable screw for use with eyelet terminals
- Tightening torque: 0.5...0.8 Nm
- Width of slot: 7.1 mm
- Maximum section of cable: 2 x 2.5 mm²
- Fire resistance: EN 60695-2-1, UL94 - V0, EN 45545-2, NFPA130
- Standards: EN 60255, EN 60947, EN 61810, EN 61373

To order

50L	P01 4002 10
48BL	P01 4002 04
78BL	P01 4002 07
96BL	P01 4002 03



SOCKETS

FRONT CONNECTION (WITH SCREW)

PAVC081 | PAVD161 | PAVG161

FOR C, D & G SERIES RELAYS

CONNECTION
FRONT

TERMINAL TYPE
SCREW

MOUNTING
PANEL / DIN RAIL

PRODUCT ADVANTAGES

- Cable secured with screws
- Mounting to panel and 35mm DIN rail
- Sturdy construction
- No internal soldering
- Provision for fitment of keying pins
- Provision for fitment of retaining clip
- Snap-in relay (PAVC, PAVD)
- IP20 protection



PAVC081



PAVD161



PAVG161

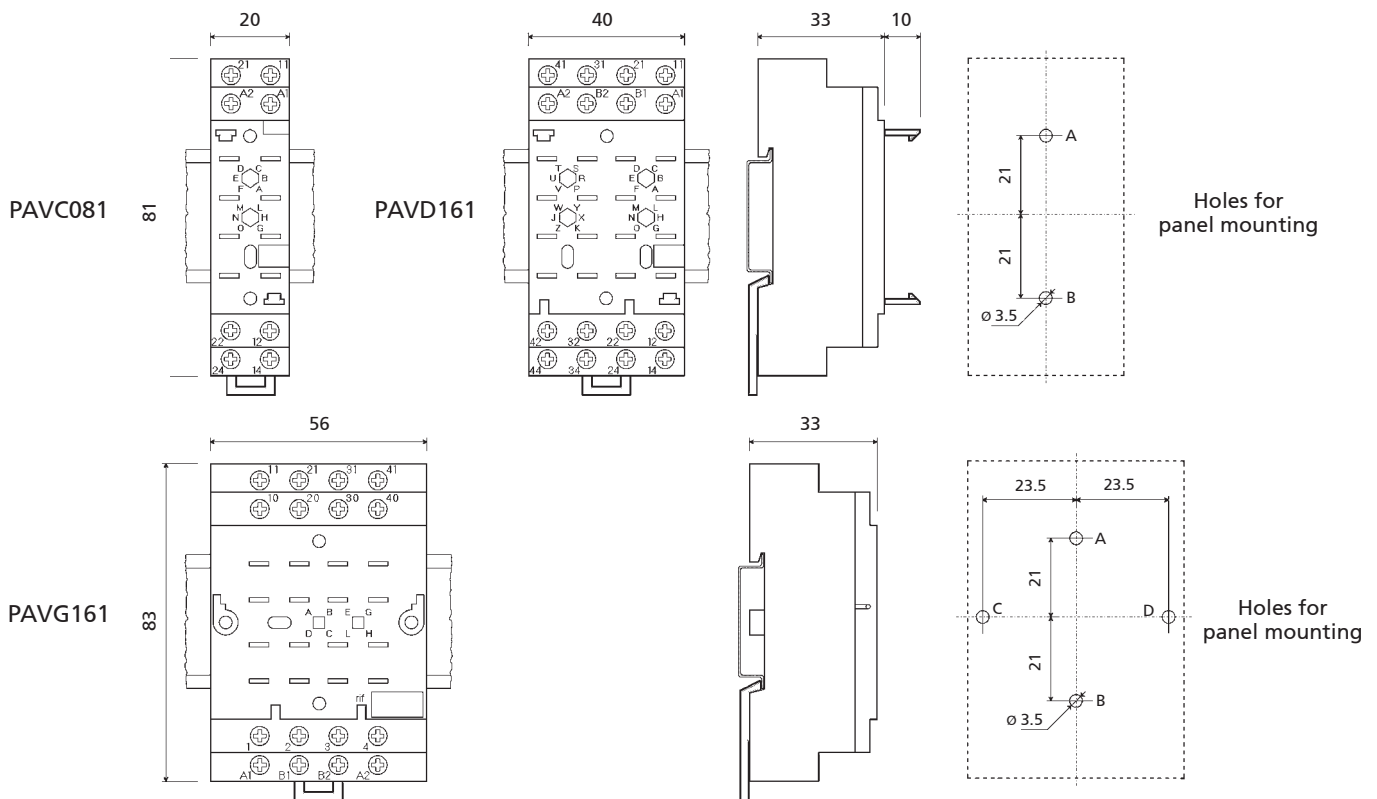

SPECIFICATIONS

Weight: 51 / 100 / 117 g

Operating temperature: -25 °C...+55 °C

Storage temperature: -40 °C...+70 °C

Panel mounting: • \varnothing holes: 5.5 mm

Mounting to Omega support:

H35 to DIN 46277/3 - EN 60715 standards

Degree of protection: IP20

Dielectric strength: 2,5 kV 50 Hz 1 min

Type and size of screw: M3 thread, cross head

Tightening torque: 0.5...0.8 Nm

Width of slot: 7,1 mm / 7,3 pour PAVG161

Maximum section of cable: 2 x 2.5 mm²

Fire resistance: EN 60695-2-1, UL94 - V0

Standards: EN 60255, EN 61810



To order

PAVC081	P01 4003 01
PAVD161	P01 4003 04
PAVG161	P01 4003 17



SOCKETS

FRONT CONNECTION (WITH SCREW)

PAVM321 | PAVM481 | PAVM801

FOR M SERIES RELAYS

CONNECTION

FRONT

TERMINAL TYPE

SCREW

MOUNTING

PANEL / DIN RAIL



PAVM321

PRODUCT ADVANTAGES

- Relay secured with screws
- Mounting to panel and 35mm DIN rail
- Sturdy construction
- No internal soldering
- Relay fastened with securing screws
- Provision for fitment of keying pins
- Protection IP20



PAVM481



PAVM801

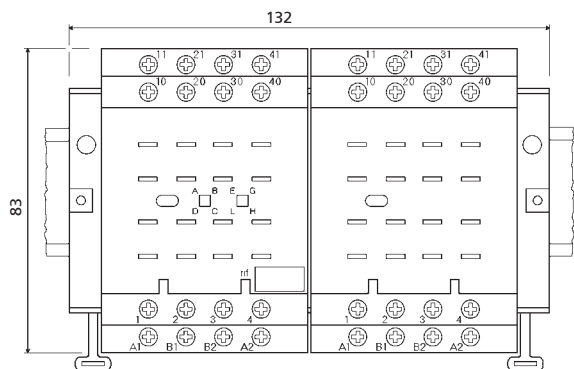

PAVM321

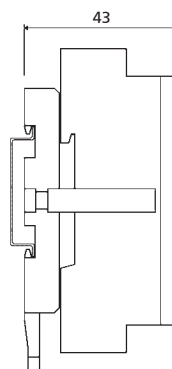

PAVM321
PAVM481
PAVM801
Side view

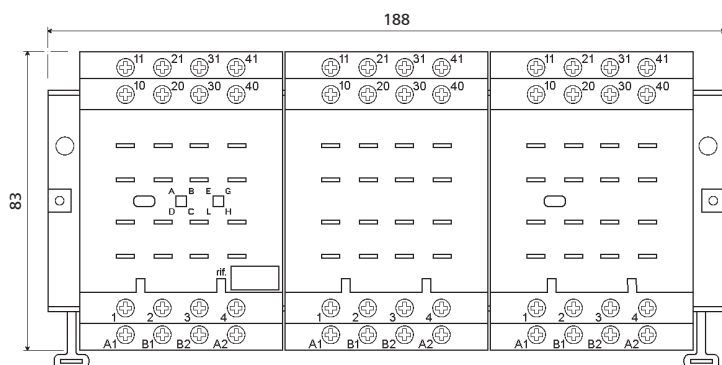

PAVM481

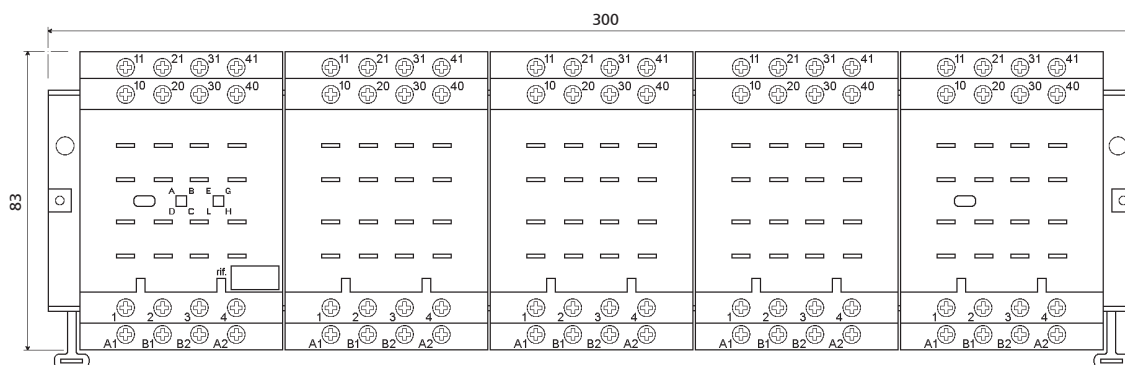

PAVM801

Outline and fixing	
Model	A
PAVM321	61 mm
PAVM481	89 mm
PAVM801	145 mm

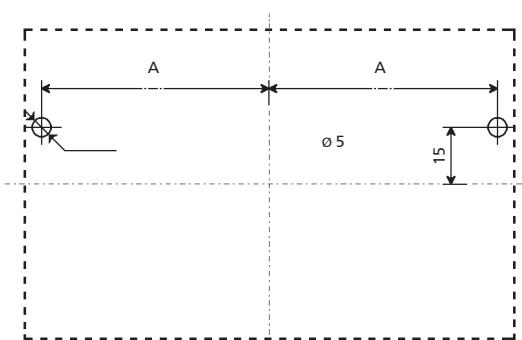

Fixing template

SPECIFICATIONS

Weight: 305 / 440 / 710 g

Operating temperature: -25°C...+55°C

Storage temperature: -40°C...+70°C

Panel mounting: • ø holes: 5 mm

Mounting to Omega support: H35 to DIN 46277/3 - EN 60715 standards

Degree of protection: IP20

Dielectric strength: 2,5 kV 50 Hz 1 min

Type and size of screw: M3 thread, cross head

Tightening torque: 0.5...0.8 Nm

Width of slot: 7.3 mm

Maximum section of cable: 2 x 2.5 mm²

Fire resistance: EN 60695-2-1, UL94 - V0

Standards: EN 60255, EN 61810

To order

PAVM321	P01 4003 46
PAVM481	P01 4003 85
PAVM801	P01 4003 86



SOCKETS

FRONT CONNECTION (WITH SCREW)

EVV 3100

CONNECTION
FRONT

TERMINAL TYPE
SCREW

MOUNTING
PANEL

PRODUCT ADVANTAGES

- Cable fixed by screws
- Mounting on panel and on 35 mm DIN RAIL (option)
- Sturdy construction
- No internal soldering

Dimensions

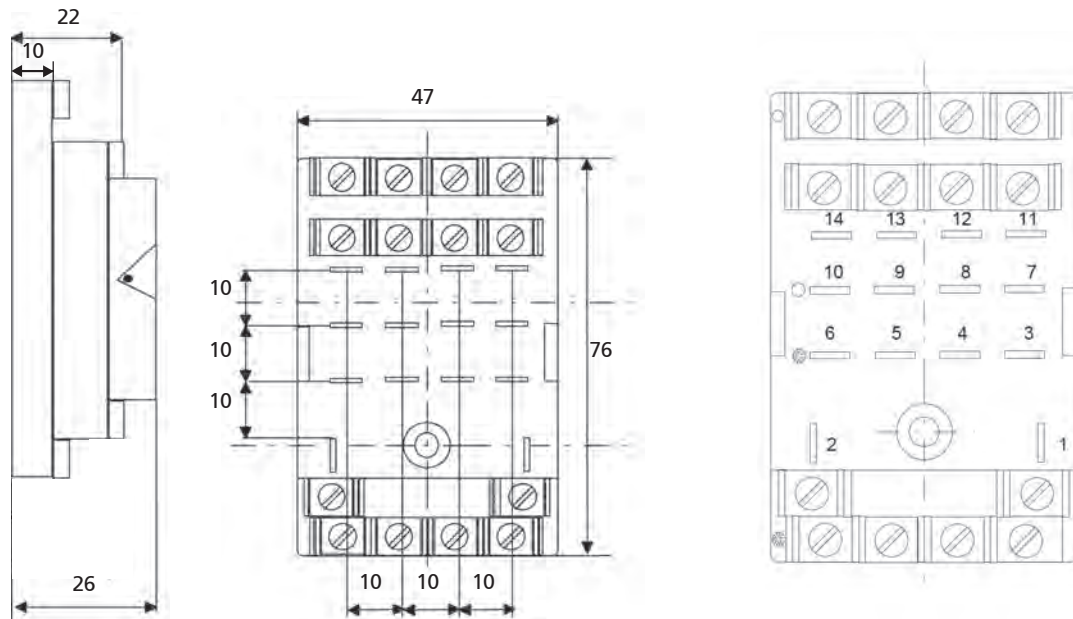

SPECIFICATIONS

Weight: 100 g

Maximum section of cable: 2.5 mm



To order

EVV 3100

EVVA 4150

For other accessories, see page 201



SOCKETS

FRONT CONNECTION (FASTON)

EVL 3100

CONNECTION
FRONT

TERMINAL TYPE
FASTON

MOUNTING
PANEL

PRODUCT ADVANTAGES

- Cable fixed by screws
- Mounting on panel and on 35 mm DIN RAIL (option)
- Sturdy construction
- No internal soldering

Dimensions

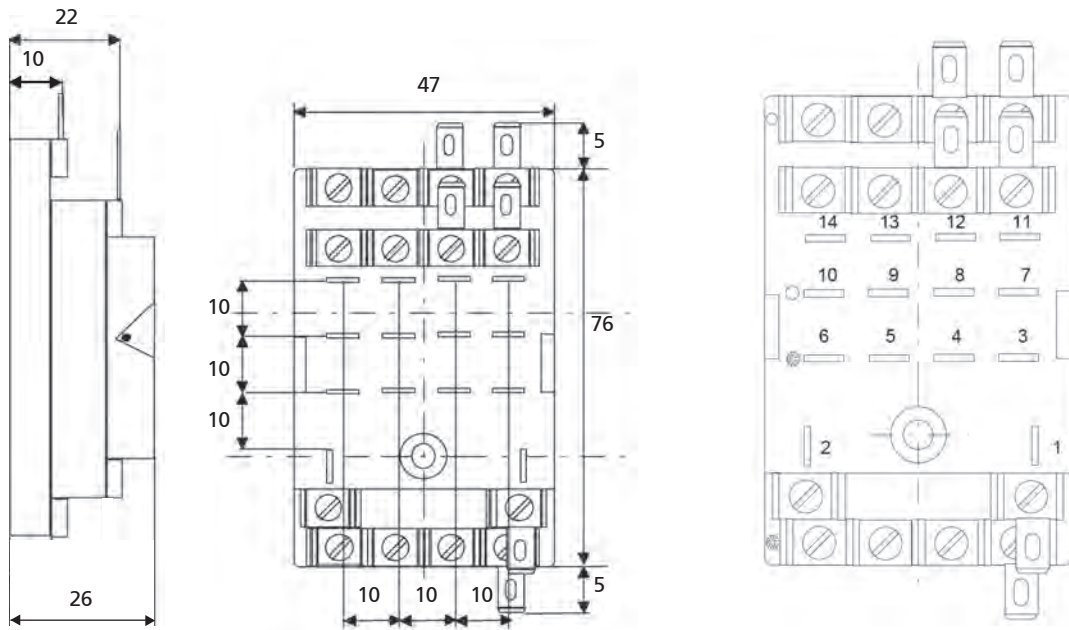

SPECIFICATIONS

Weight: 100 g
Blade width: 5 mm

To order	
EVL 3100	EVVB 4149

For other accessories, see page 201

BIST

FAST-ACTING (MONOSTABLE AND BISTABLE)

TIME DELAY (ON PICK-UP OR DROP-OUT)

TIME DELAY WITH FORCIBLY GUIDED CONTACTS

MEASUREMENT

SOCKET NUMBERING EXPLANATIONS

FRONT CONNECTION

FRONT CONNECTION

BACK CONNECTION

PCB MOUNT

RETAINING CLIPS



SOCKETS

REAR CONNECTION (WITH SPRING CLAMP)

PRIR08x | PRIR16x | PRIR24x | PRIR32x | PRIR48x

CONNECTION
REAR

TERMINAL TYPE
SPRING CLAMP

MOUNTING
PANEL

PRODUCT ADVANTAGES

- Cable secured with spring clamp mechanism
- Insertion of cable with no need for tools
- Quick and easy wiring, saving more than half the time taken with conventional wiring
- Panel mounting
- Excellent contact pressure on relay terminals
- Sturdy construction, no internal soldering
- Compatible with cable up to 2.5mm², bare (flexible or rigid) and with lug; 2 inputs per terminal
- Provision for fitment of keying pins
- Provision for fitment of retaining clip
- Protection IP20



PRIR08x



PRIR16x

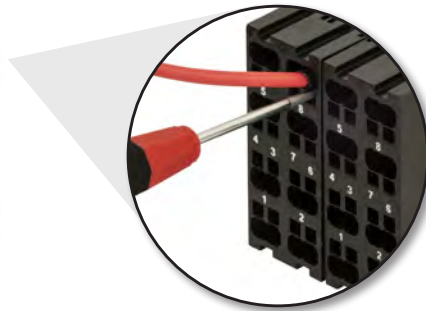

Detail of connections



PRIR24x



PRIR32x



PRIR48x

PRIR08x

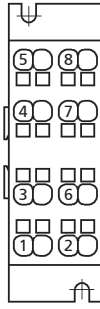
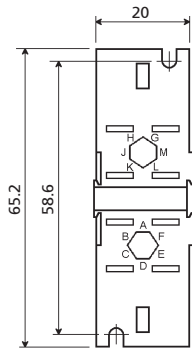

PRIR080
Rear view

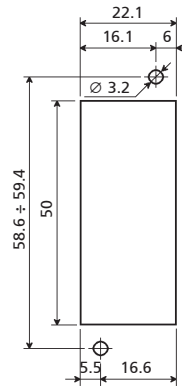

Drilling template

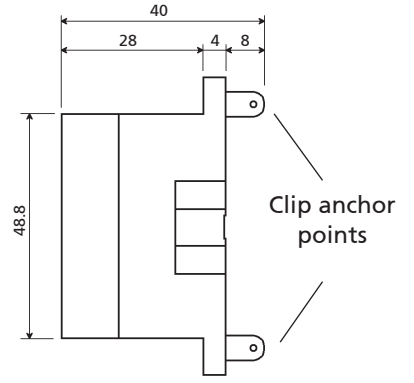

Side view

PRIR16x

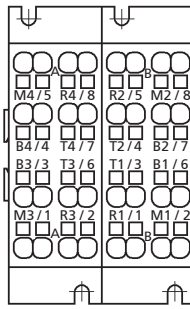
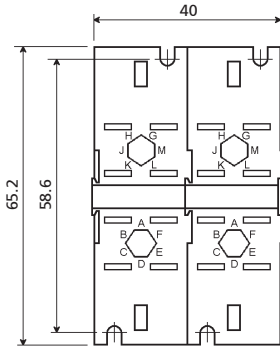

Rear view
PRIR160

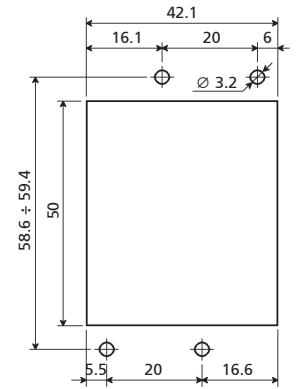

Drilling template

PRIR24x

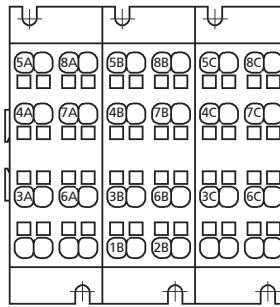
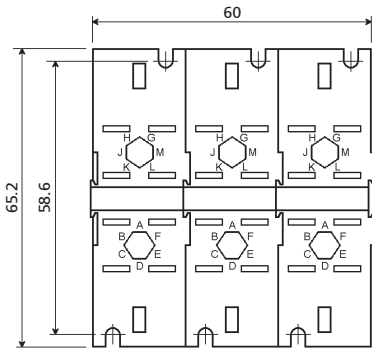

PRIR240
Model with "TRIPOK" numbering
Rear view

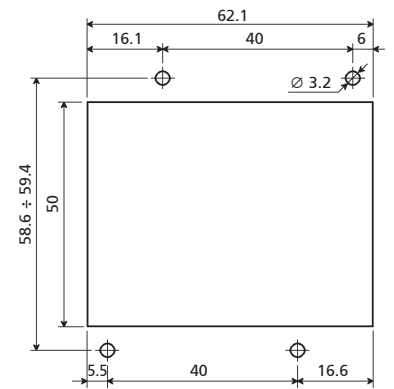

Drilling template

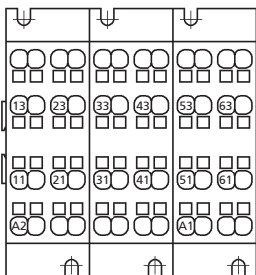

PRIR241
Model with numbering for RVLV16/1

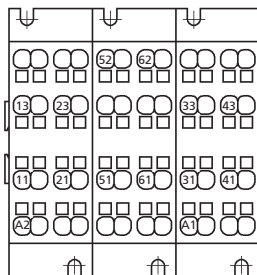

PRIR242
Model with numbering for RVLV16/2

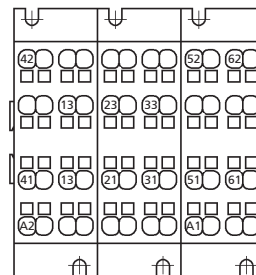

PRIR243
Model with numbering for RVLV16/3

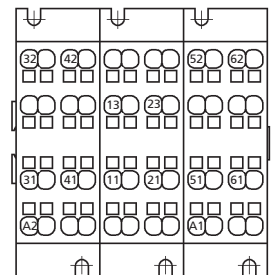

PRIR244
Model with numbering for RVLV16/5

INSTANTANÉES MONOSTABLES FORCIBLEMENT GUIDÉES CONTACTS
BISTABLES
FAST-ACTING MONOSTABLES (AND BISTABLES)
TIME DELAY (ON PICK-UP OR DROP-OUT)
TIME DELAY WITH FORCIBLY GUIDED CONTACTS
MEASUREMENT
SOCKET NUMBERING EXPLANATIONS
FRONT CONNECTION
BACK CONNECTION
PCB MOUNT
RETAINING CLIPS
KEYING

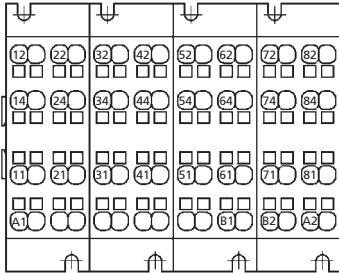
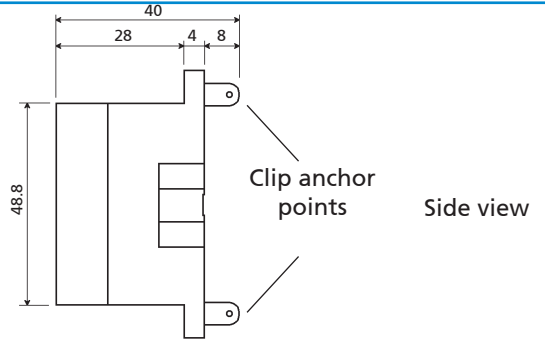
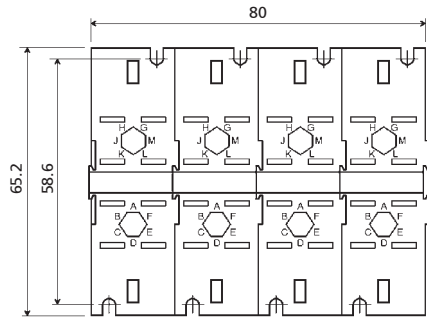

PRIR320 Rear view

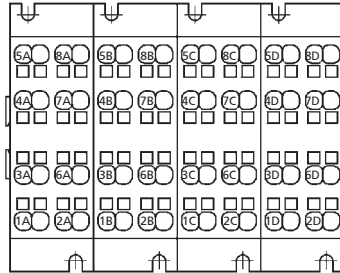

PRIR321 Rear view

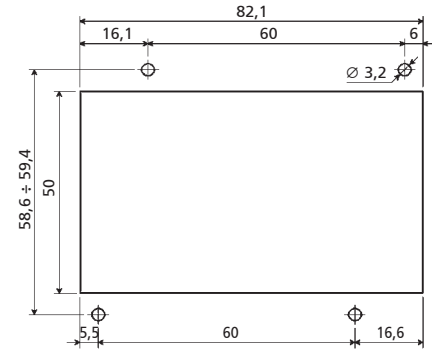

Drilling template

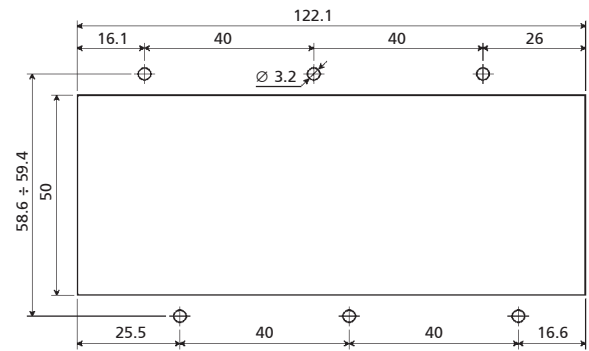
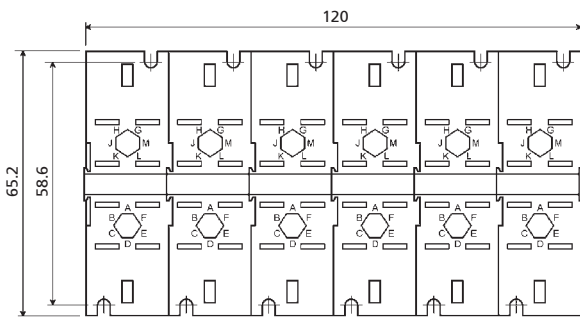

Drilling template

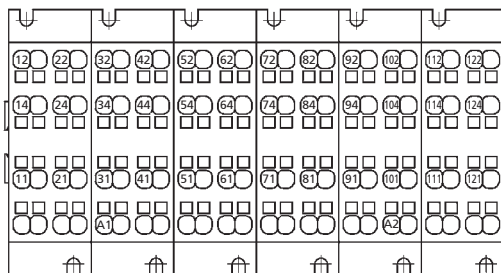

PRIR480 / Model with "ESAPOK" numbering

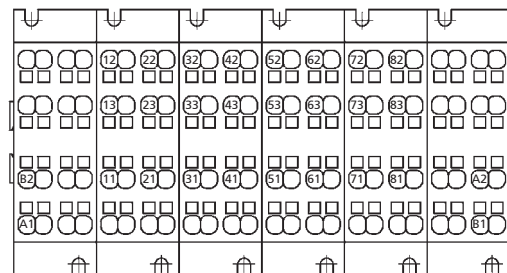

PRIR481 / Model with "BAS8NB" numbering

SPECIFICATIONS

Weight: 35 / 70 / 105 / 140 / 210 g
Operating temperature: -50 °C...+70 °C
Storage temperature: -50 °C...+85 °C
Panel mounting: • Ø holes: 3.2 mm
Degree of protection: IP20
Dielectric strength: 2.5 kV 50 Hz 1 min
Fire resistance: EN 60695-2-1, UL94 - V0, EN 45545-2, NFPA130
Standards: EN 61810, EN 61373
Terminal type: spring clamp
Inputs for each relay terminal: 2

Minimum section of cable:
 • cable without lug: 1 mm²
 • cable with lug: 0.5 mm²
Maximum section of cable: 2.5 mm²
Wire stripping length, mm: 10 mm ± 0.5 mm
Length of lug: 12 mm
Wiring with rigid cables or lug: pressure grip
Wiring with flexible cables, extraction of cables: using screwdriver type tool with slim shaft and slotted head measuring 2.5mm x 0.4mm, inserted perpendicularly to the socket.

To order

PRIR080	P01 4002 60
PRIR160	P01 4002 61
PRIR240	P01 4002 62
PRIR320	P01 4002 63
PRIR480	P01 4002 64



REAR CONNECTION (WITH SCREW)

SOCKETS

53IL | 43IL | 73IL

CONNECTION
REAR

TERMINAL TYPE
SCREW

MOUNTING
PANEL

PRODUCT ADVANTAGES

- Cable secured with removable screws
- Panel mounting
- Sturdy construction
- Excellent contact pressure on relay terminals
- No internal soldering
- Inputs for maximum section 2.5 mm²
- Provision for fitment of keying pins
- Provision for fitment of retaining clip
- Protection IP10

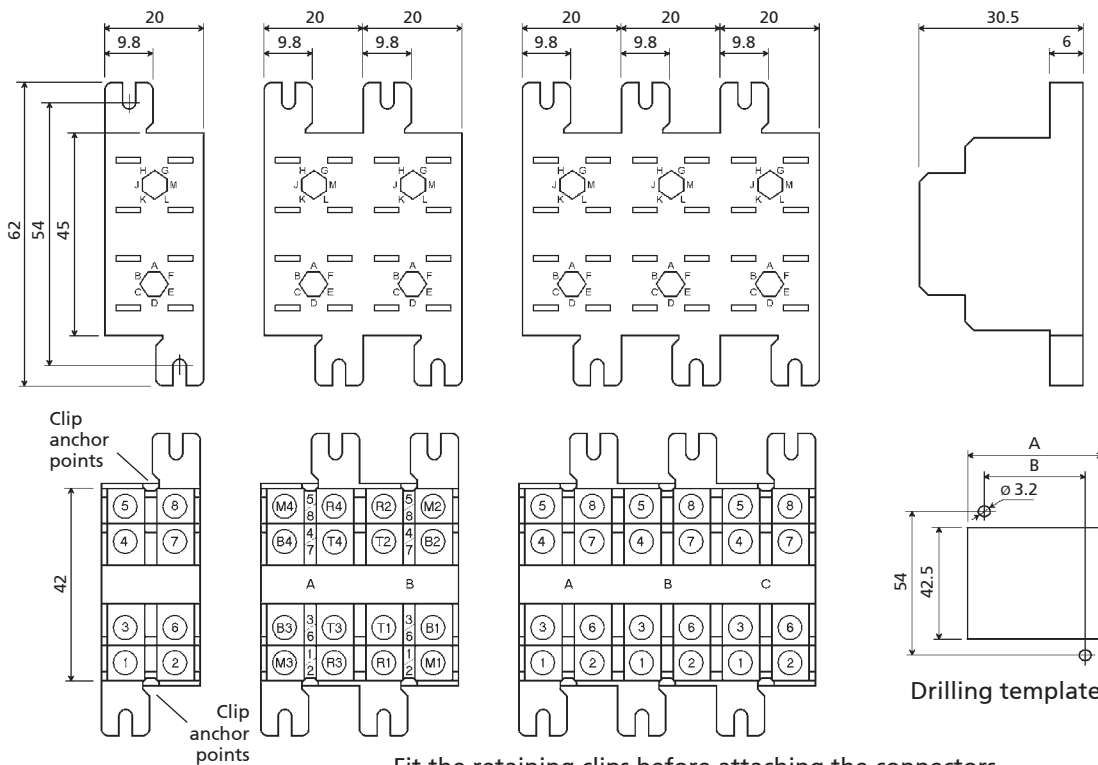
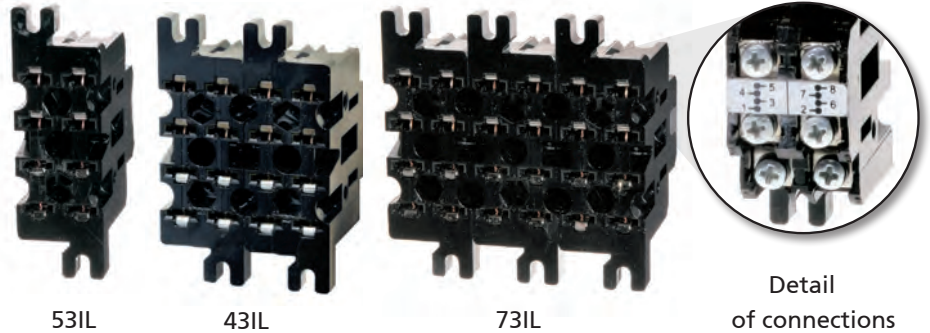

	A	B
53IL	20.5	10
43IL	40.5	30
73IL	60.5	50

Fit the retaining clips before attaching the connectors

SPECIFICATIONS

Weight: 41 / 82 / 123 g
Operating temperature: -25 °C...+70 °C
Storage temperature: -40 °C...+85 °C
Degree of protection: IP10
Dielectric strength: 2.5 kV 50 Hz 1 min
Type and size of screw: M3 thread, cross head
 Removable screw for use with eyelet terminals

Tightening torque: 0.5...0.8 Nm
Width of slot: 5.4 mm
Maximum section of cable: 2 × 2.5 mm²
Fire resistance: EN 60695-2-1, UL94 - V0, EN 45545-2, NFPA130
Standards: EN 60255, EN 60947, EN 61810, EN 61373



To order

53IL	P01 4002 40
43IL	P01 4002 41
73IL	P01 4002 42



SOCKETS

REAR CONNECTION (WITH SCREW)

PRVC081 | PRVD161

FOR C & D SERIES RELAYS

CONNECTION	TERMINAL TYPE	MOUNTING
REAR	SCREW	PANEL

PRODUCT ADVANTAGES

- Cable secured with screws
- Panel mounting
- Sturdy construction
- No internal soldering
- Snap-in relay
- Provision for fitment of keying pins
- Protection IP10



PRVC081



Detail of connections



PRVD161

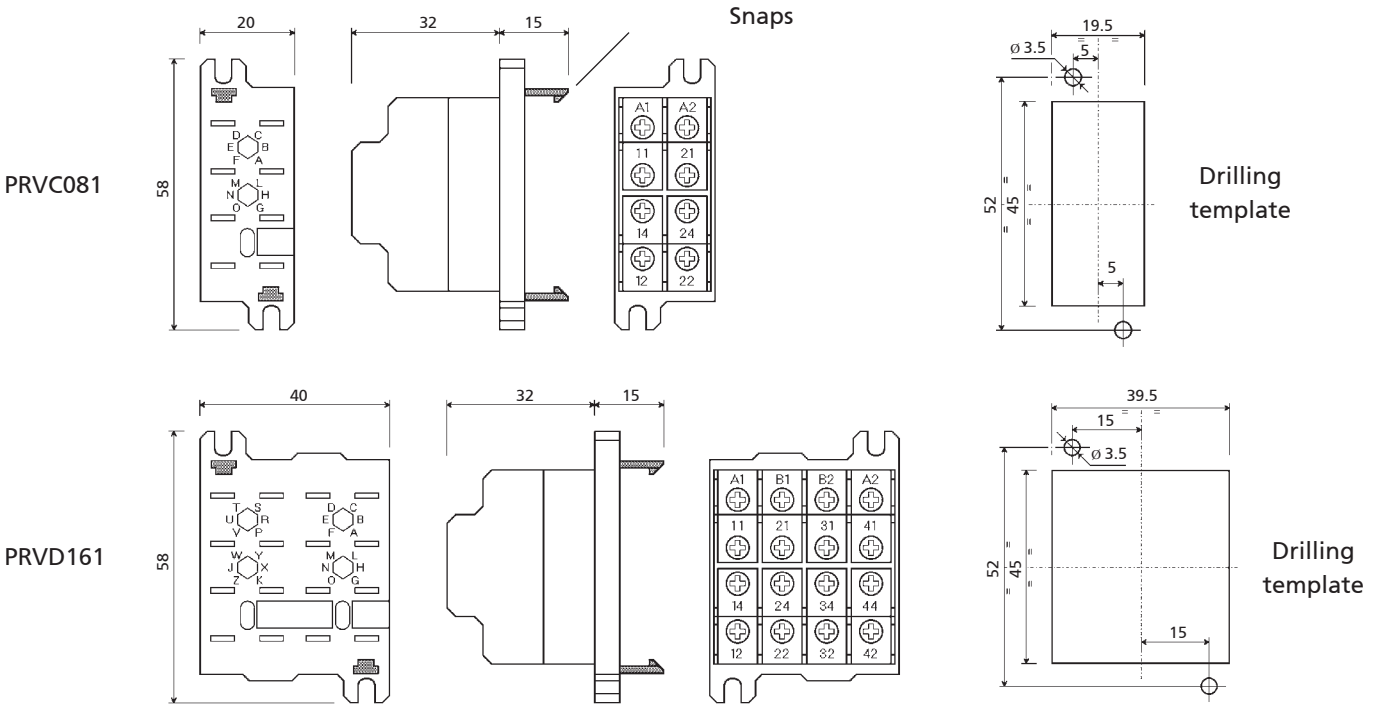

SPECIFICATIONS

Weight: 39 / 78 g
 Operating temperature: -25 °C...+55 °C
 Storage temperature: -40 °C...+70 °C
 Panel mounting: • \varnothing holes: 3.5 mm
 Degree of protection: IP10
 Dielectric strength: 2.5 kV 50 Hz 1 min

Type and size of screw: M3 thread, cross head
 Tightening torque: 0.5...0.8 Nm
 Width of slot: 7 mm
 Maximum section of cable: 2 x 2.5 mm²
 Fire resistance: EN 60695-2-1, UL94 - V0
 Standards: EN 60255, EN 61810

To order	
PRVC081	P01 4003 13
PRVD161	P01 4003 14

INSTANTANÉES MONOSTABLES FORCIBLEMENT GUIDÉES CONTACTS

INSTANTANÉES MONOSTABLES WITH FORCIBLY GUIDED CONTACTS

BISTABLE

FAST-ACTING MONOSTABLE (AND BISTABLE)

TIME DELAY (ON PICK-UP OR DROP-OUT)

TIME DELAY WITH FORCIBLY GUIDED CONTACTS

MEASUREMENT

SOCKET NUMBERING EXPLANATIONS

FRONT CONNECTION

BACK CONNECTION

PCB MOUNT

RETAINING CLIPS

KEYING



SOCKETS

REAR CONNECTION (WITH SCREW)

PRVG161

FOR G SERIES RELAYS

CONNECTION	TERMINAL TYPE	MOUNTING
REAR	SCREW	PANEL

PRODUCT ADVANTAGES

- Cable secured with screws
- Panel mounting
- Sturdy construction
- No internal soldering
- Provision for fitment of keying pins
- Provision for fitment of retaining clip
- Protection IP10



PRVG161

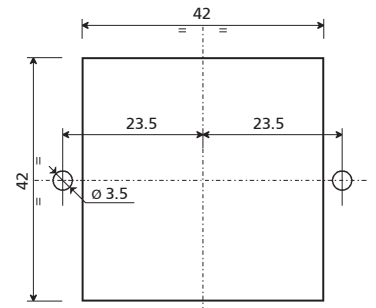
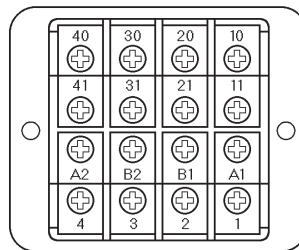
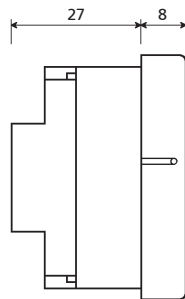
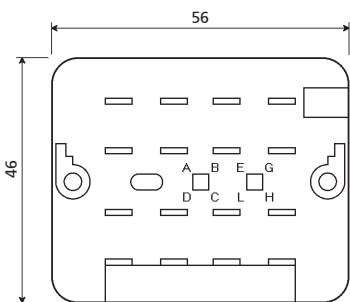

Drilling template

SPECIFICATIONS

Weight: 85 g
Operating temperature: -25 °C...+55 °C
Storage temperature: -40 °C ... +70 °C
Panel mounting: • ø holes: 3.5 mm
Degree of protection: IP10
Fire resistance: EN 60695-2-1, UL94 - V0
Standards: EN 60255, EN 61810

Dielectric strength: 2.5 kV 50 Hz 1 min
Type and size of screw: M3 thread, cross head
Tightening torque: 0.5...0.8 Nm
Width of slot: 7 mm
Maximum section of cable: 2 x 2.5 mm²

To order	
PRVG161	P01 4003 21



SOCKETS

REAR CONNECTION (WITH SCREW)

PRVM321 | PRVM481 | PRVM801

FOR M SERIES RELAYS

CONNECTION

REAR

TERMINAL TYPE

SCREW

MOUNTING

PANEL

PRODUCT ADVANTAGES

- Cable secured with screws
- Panel mounting
- Sturdy construction
- No internal soldering
- Relay fastened with securing screws
- Provision for fitment of keying pins
- Protection IP10



PRVM321



Detail of connections



PRVM481



PRVM801

INSTANTANÉES MONOSTABLES FORCIBLY GUIDED CONTACTS

INSTANTANÉES MONOSTABLES WITH FORCIBLY GUIDED CONTACTS

BISTABLE

FAST-ACTING MONOSTABLE (AND BISTABLE)

TIME DELAY (ON PICK-UP OR DROP-OUT)

TIME DELAY WITH FORCIBLY GUIDED CONTACTS

MEASUREMENT

SOCKET NUMBERING EXPLANATIONS

FRONT CONNECTION

BACK CONNECTION

PCB MOUNT

RETAINING CLIPS

KEYING

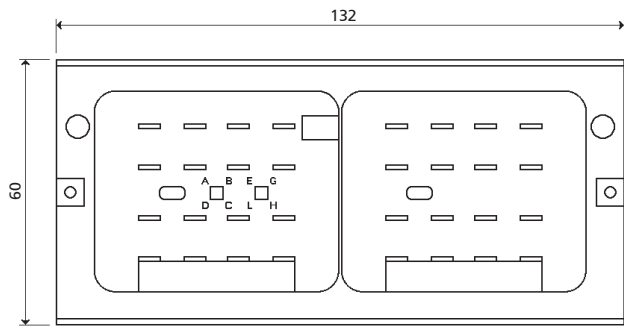

PRVM321

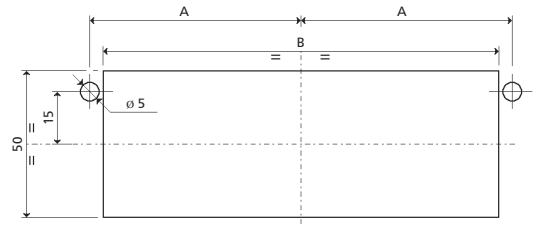

Drilling template

Model	A	B
PAVM321	61	110
PAVM481	89	166
PAVM801	145	278

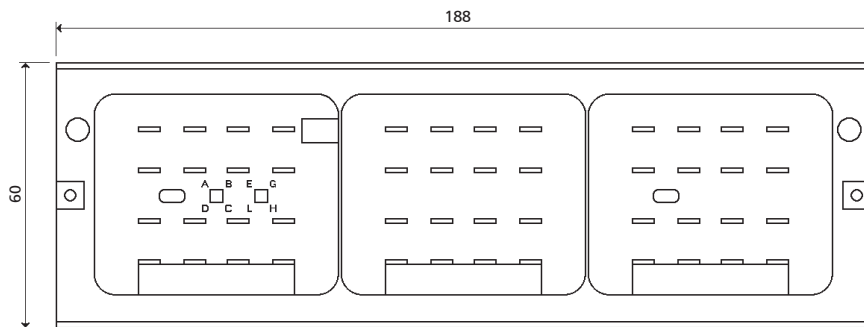

PRVM481

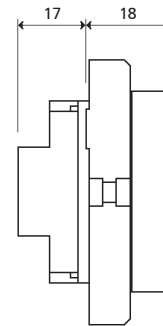

Side view

PRVM321
PRVM481
PRVM801

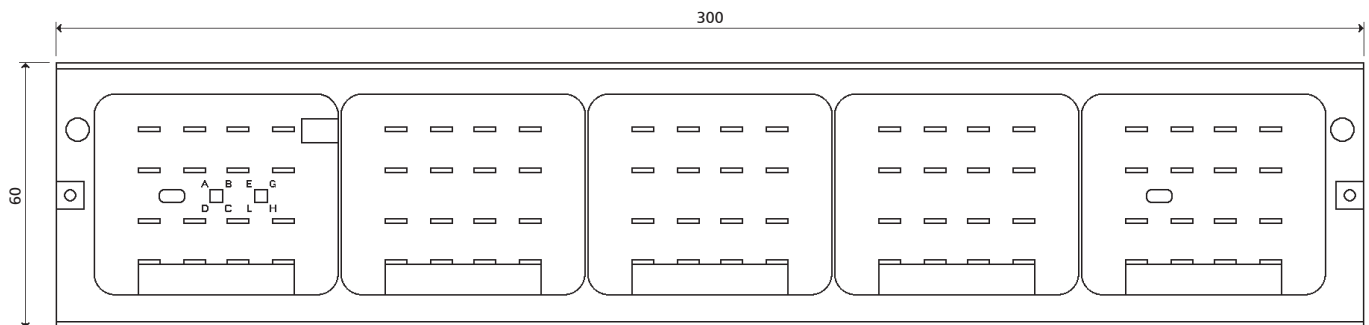

PRVM801

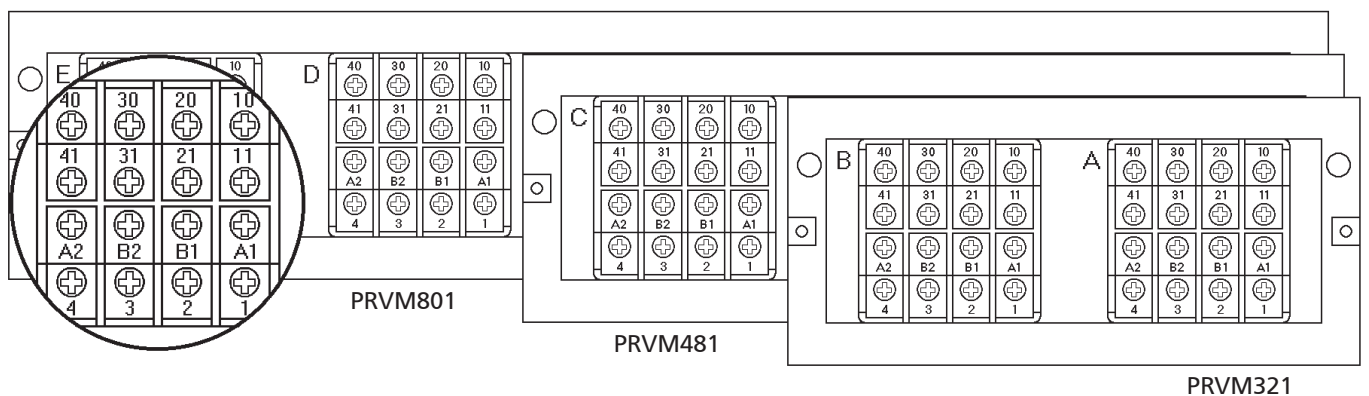

SPECIFICATIONS

Weight: 220 / 350 / 520 g
Operating temperature: -25 °C...+55 °C
TStorage temperature: -40 °C...+70 °C
Panel mounting: • ø holes: 5 mm
Degree of protection: IP10
Dielectric strength: 2.5 kV 50 Hz 1 min

Type and size of screw: M3 thread, cross head
Tightening torque: 0.5...0.8 Nm
Width of slot: 7 mm
Maximum section of cable: 2 × 2.5 mm²
Fire resistance: EN 60695-2-1, UL94 - V0
Standards: EN 60255, EN 61810

To order

PRVM321	P01 4003 52
PRVM481	P01 4003 53
PRVM801	P01 4003 54



SOCKETS

REAR CONNECTION (WITH SCREW)

ERV 310

CONNECTION
REAR

TERMINAL TYPE
SCREW

MOUNTING
FLUSH

PRODUCT ADVANTAGES

- Cable secured by screws
- Sturdy construction
- No internal soldering

Dimensions

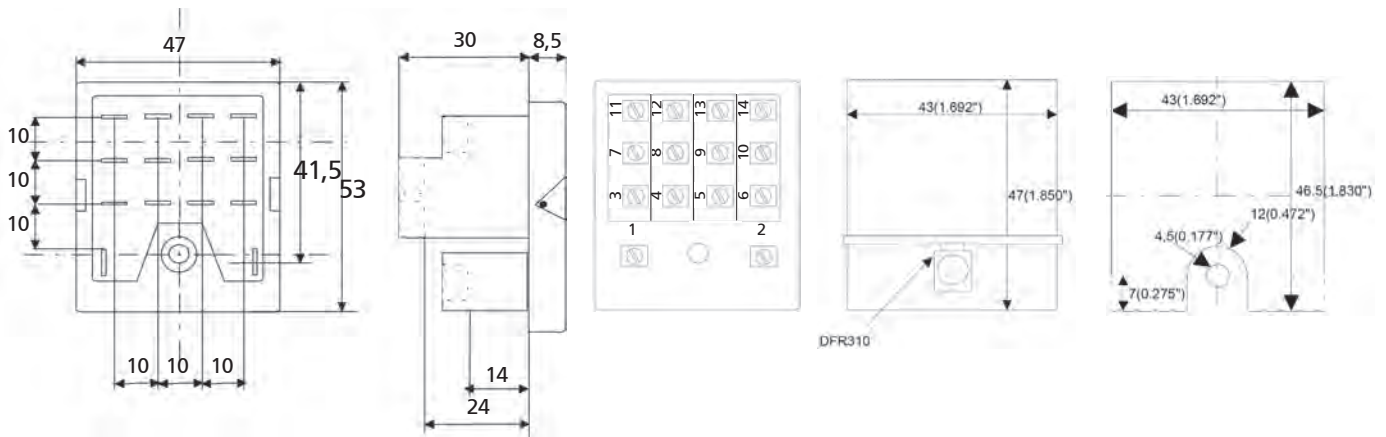

SPECIFICATIONS

Weight: 100 g



To order

ERV 310

ERVA 4153

For other accessories, see page 201



REAR CONNECTION (SINGLE FASTON)

SOCKETS

84F

CONNECTION
REAR

TERMINAL TYPE
SCREW

MOUNTING
PANEL

PRODUCT ADVANTAGES

- Sturdy construction
- No internal soldering

Dimensions

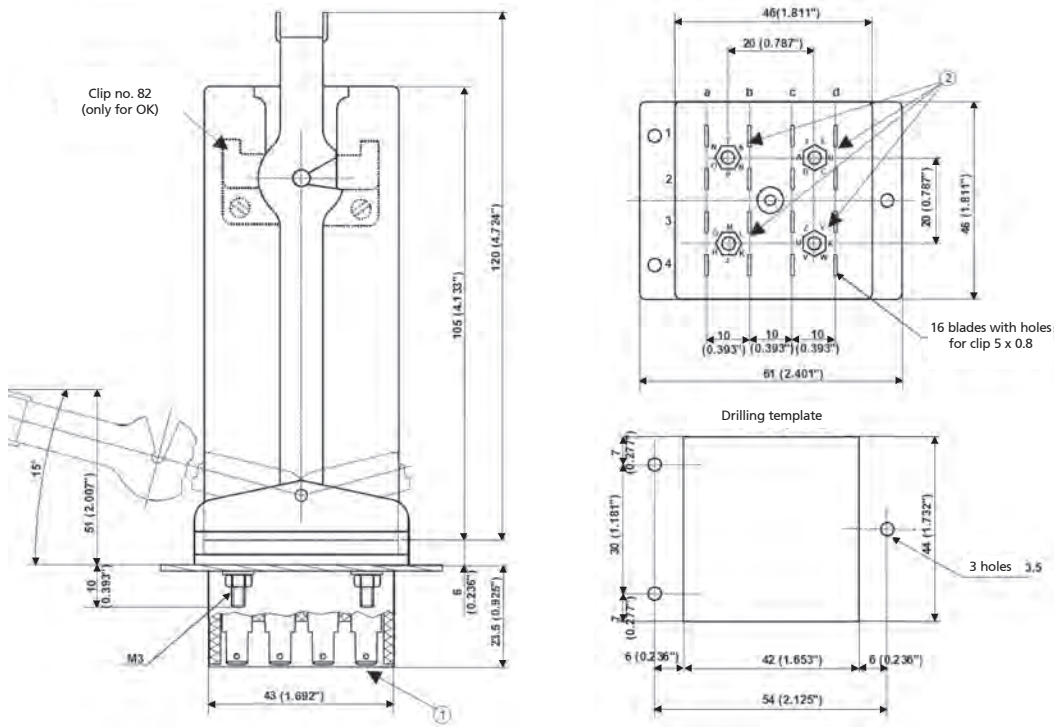

SPECIFICATIONS

Weight: 120 g

Operating temperature: -40 to +70°C

To order	
84F	ACC.84F
ADAPTER KIT N82	P01 4002 11

INSTANTANÉ MONOSTABLE MONOSTABLE

INSTANTANÉ MONOSTABLE WITH FORCIBLY GUIDED CONTACTS

BISTABLE

FAST-ACTING MONOSTABLE (AND BISTABLE)

TIME DELAY (ON PICK-UP OR DROP-OUT)

TIME DELAY WITH FORCIBLY GUIDED CONTACTS

MEASUREMENT

SOCKET NUMBERING EXPLANATIONS

FRONT CONNECTION

BACK CONNECTION

PCB MOUNT

RETAINING CLIPS

KEYING



ADF1 | ADF2 | ADF3 | ADF4 | ADF6

CONNECTION	TERMINAL TYPE	MOUNTING
REAR	DOUBLE FASTON	PANEL

PRODUCT ADVANTAGES

- Connection of cable with faston clip
- 2 inputs for each relay terminal
- Sturdy construction
- Excellent contact pressure on relay terminals
- No internal soldering
- Provision for fitment of keying pins
- Provision for fitment of retaining clip
- Protection IP20



ADF1



ADF2

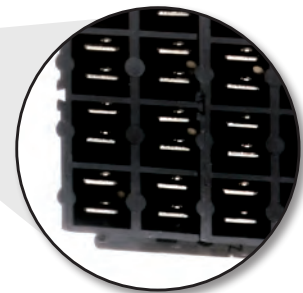

Detail of connections



ADF3



ADF4



ADF6

ADF1

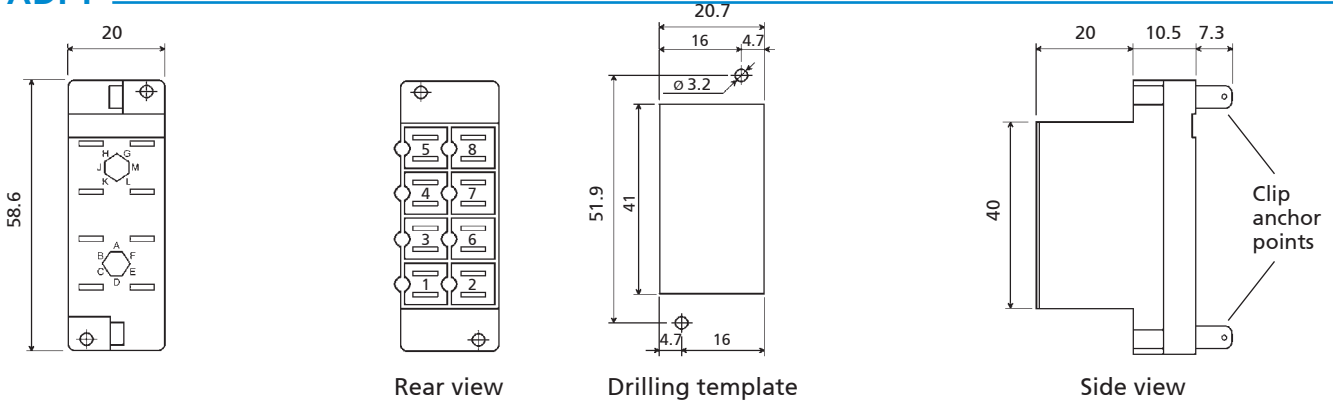

ADF2

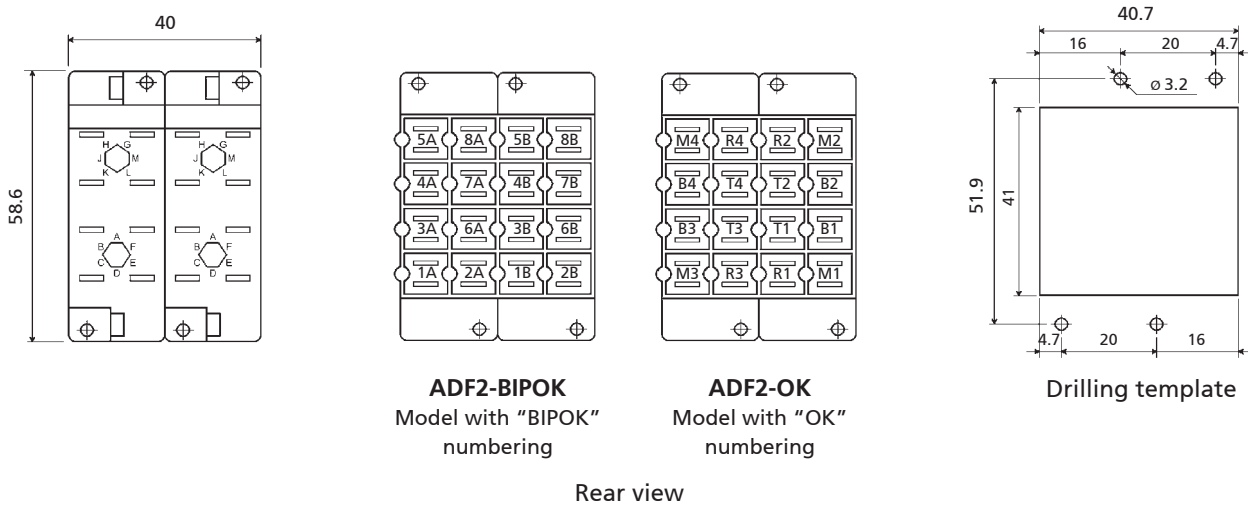

ADF3

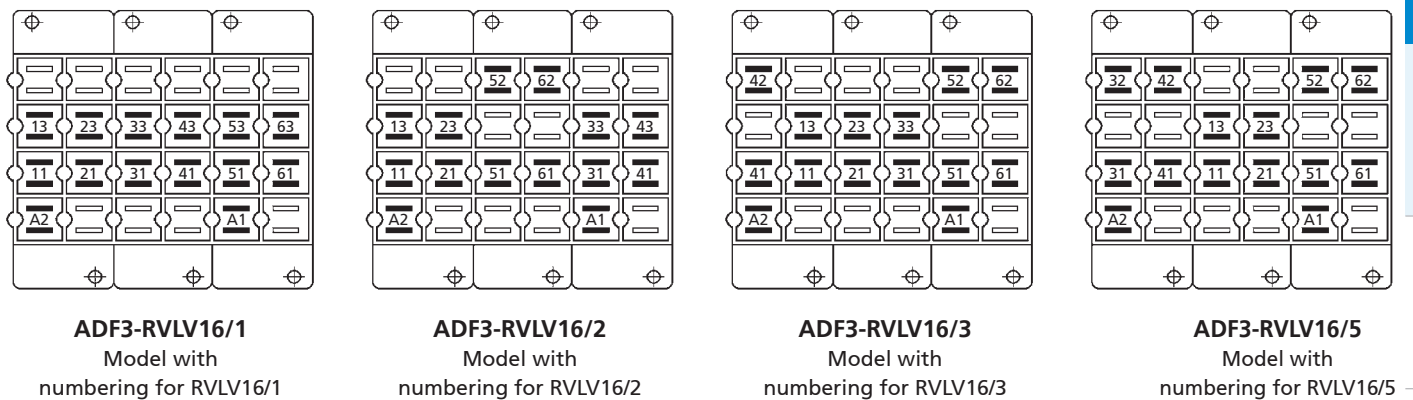
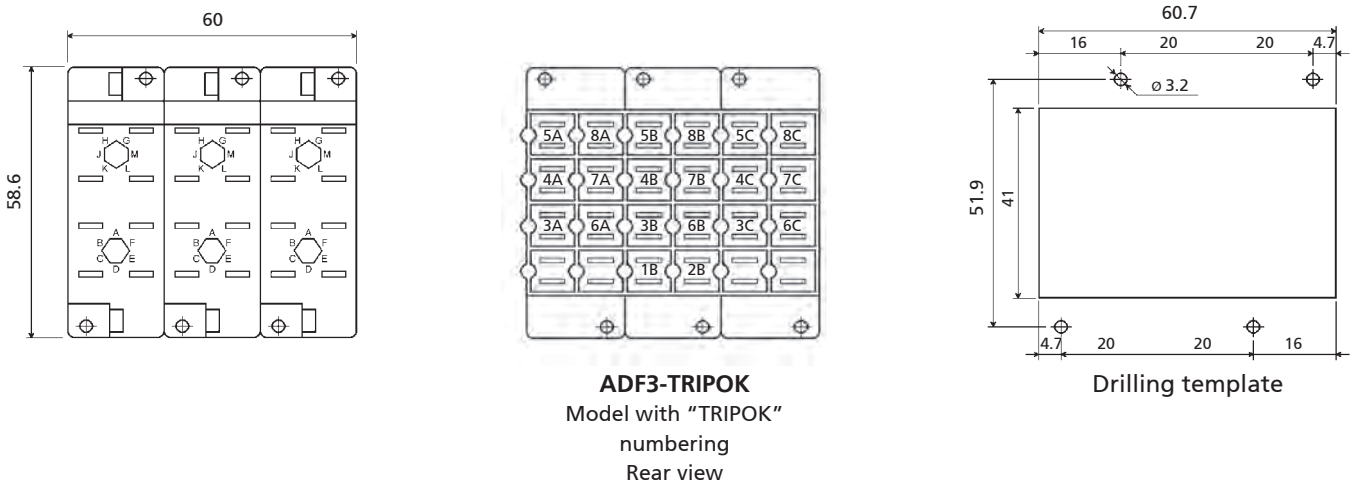

ADF4

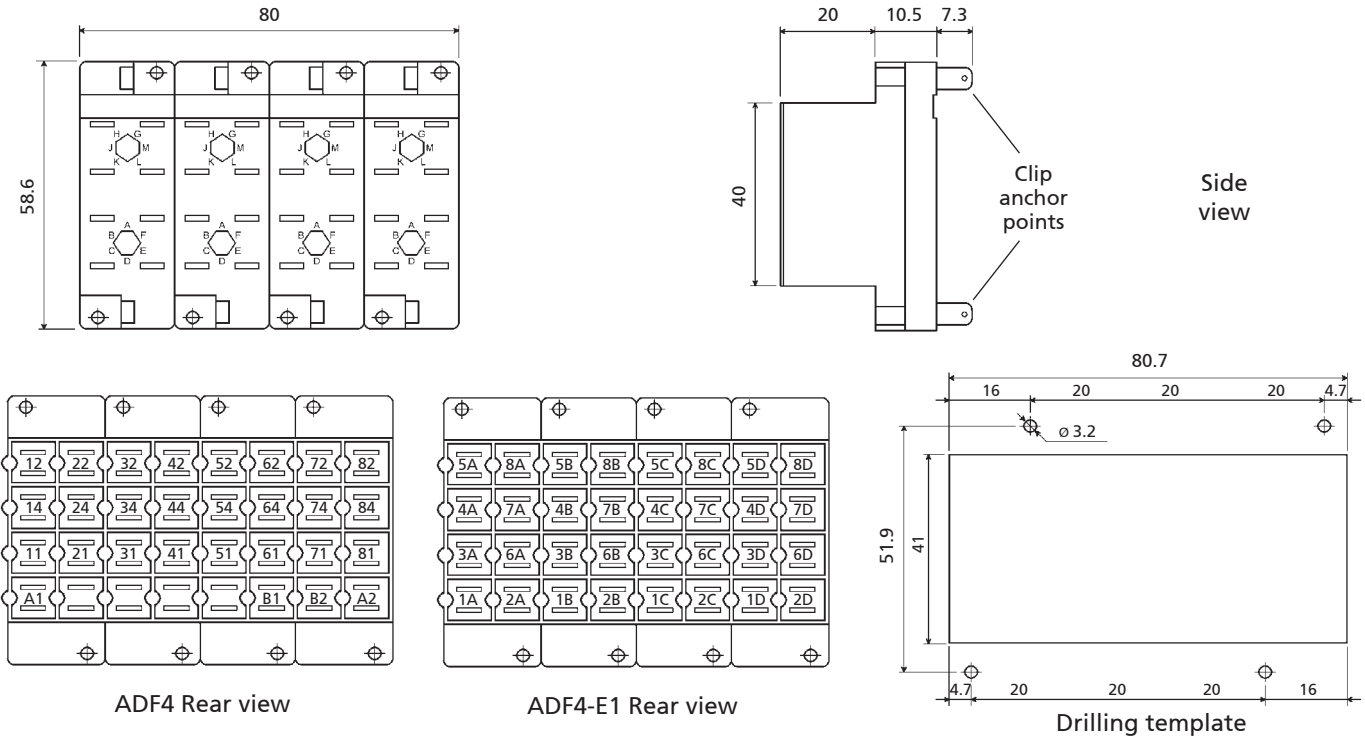

ADF6

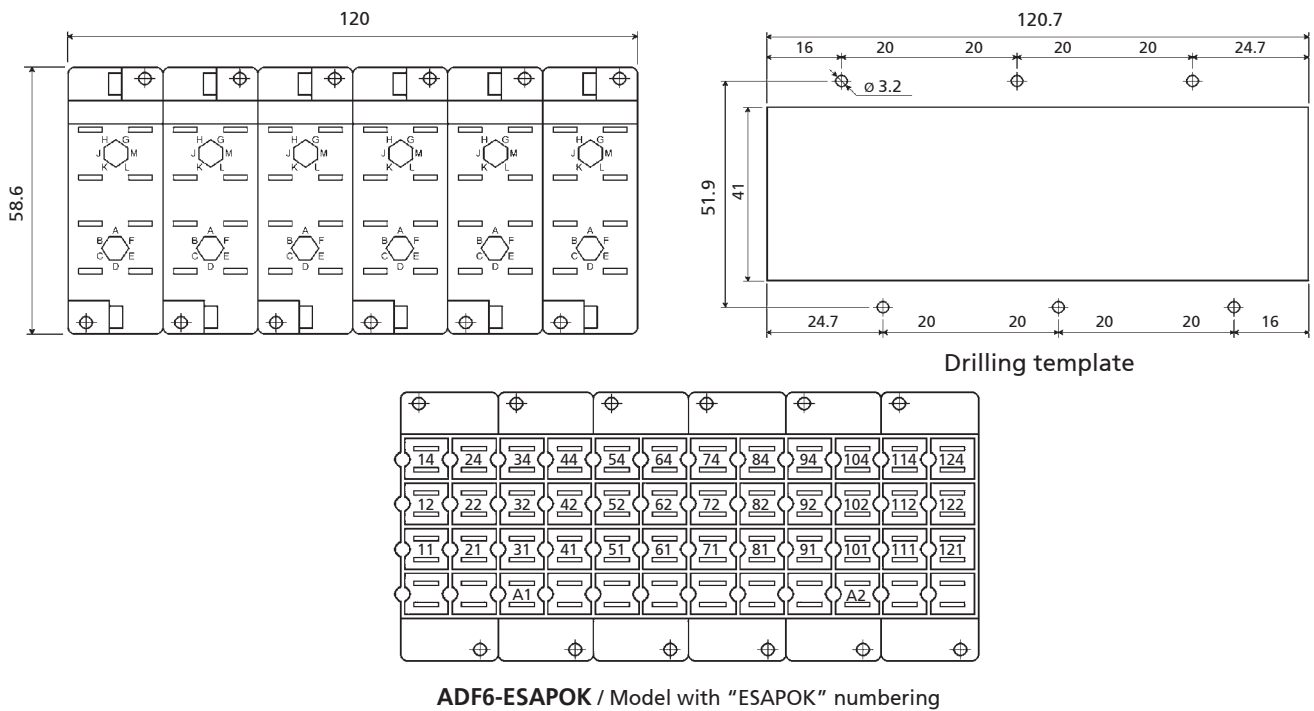

SPECIFICATIONS

Weight: 32 / 64 / 96 / 128 / 192 g
Operating temperature: -25 °C...+70 °C
Storage temperature: -40 °C...+85 °C
Degree of protection: IP10
Dielectric strength: 2.5 kV 50 Hz 1 min
Type and size of faston clip: 2 × 4,8×0.8
Width of slot: 8 mm
Maximum section of cable: 2 × 2.5 mm²
Fire resistance: EN 60695-2-1, UL94 - V0, EN 45545-2
Standards: EN 60255, EN 60947, EN 61810, EN 61373



To order

ADF1	P01 4002 50
ADF2 - OK (UTM)	P01 4002 51
ADF2 - BIPOK	P01 4002 52
ADF3 - TRIPOK	P01 4002 53
ADF3 - RVLV16/1	P01 4002 54
ADF3 - RVLV16/2	P01 4002 55
ADF3 - RVLV16/3	P01 4002 56
ADF3 - RVLV16/5	P01 4002 57
ADF4	P01 4002 59
ADF6	P01 4002 58



CONNECTION
REAR

TYPE DE BORNE
DOUBLE FASTON

MOUNTING
PANEL

PRODUCT ADVANTAGES

- Connection of cable with faston clip
- Panel mounting
- 2 inputs for each relay terminal
- Sturdy construction
- No internal soldering
- Relay fastened with securing screws
- Provision for fitment of keying pins
- Protection IP10



PRDM321



Detail of connections



PRDM481



PRDM801

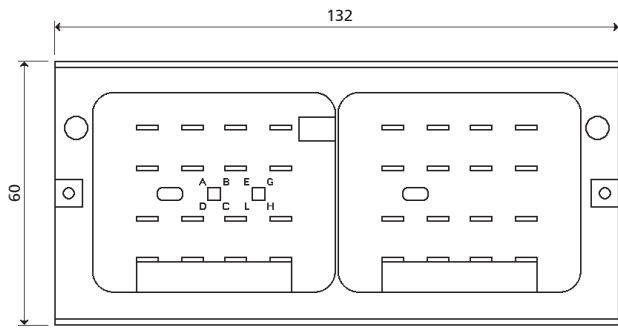

PRDM321

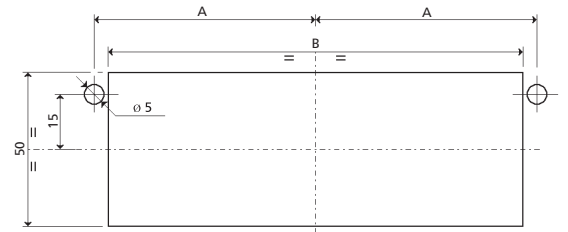

Drilling template

Model	A	B
PRDM321	61	110
PRDM481	89	166
PRDM801	145	278

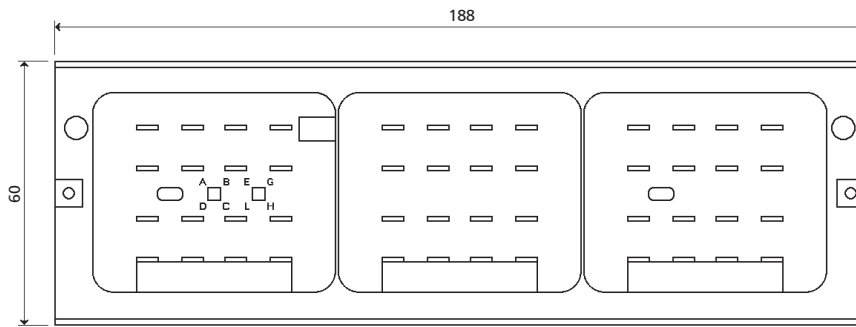

PRDM481

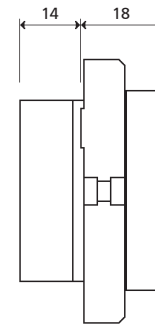

Side view

PRDM321
PRDM481
PRDM801

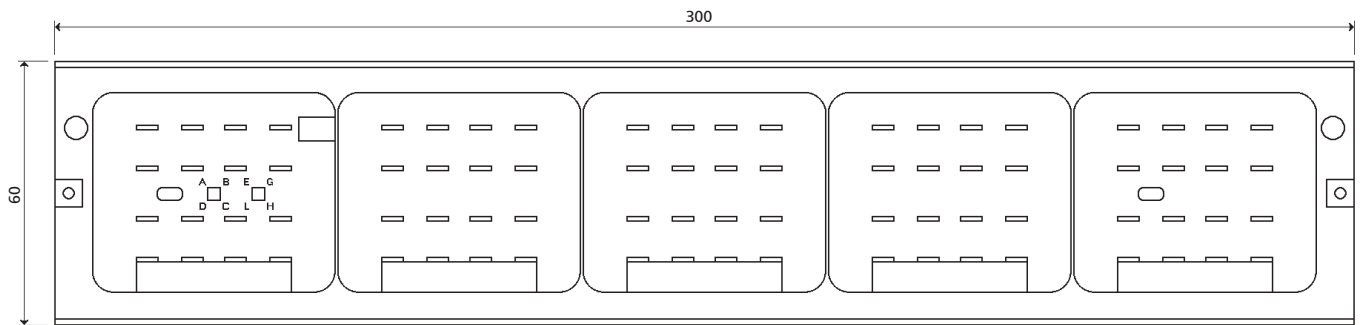

PRDM801

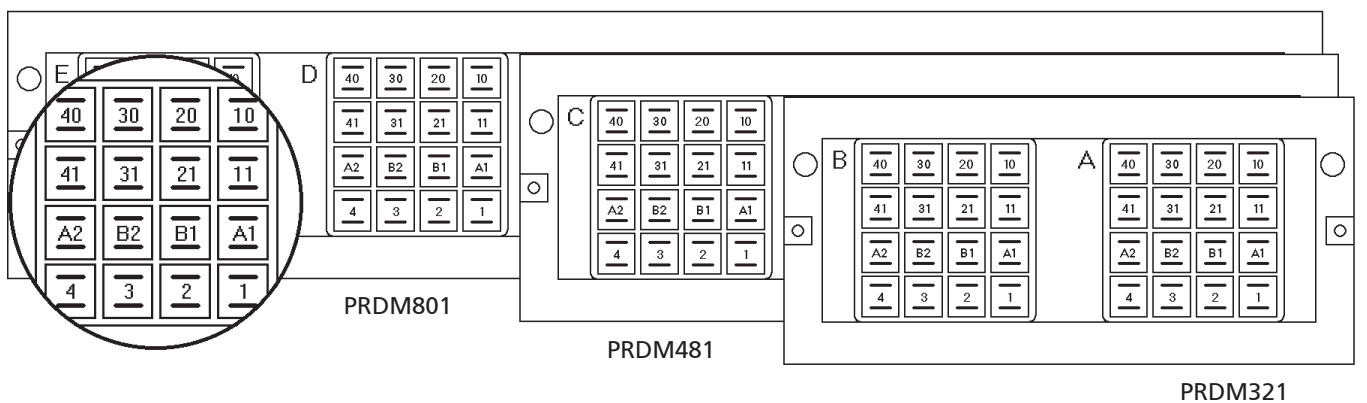

PRDM801

PRDM481

PRDM321

SPECIFICATIONS

Weight: 220 / 350 / 520 g

Operating temperature: -25 °C...+55 °C

Storage temperature: -40 °C...+70 °C

Panel mounting:

- ø holes: 5 mm

Degree of protection: IP10

Dielectric strength: 2.5 kV 50 Hz 1 min

Type and size of faston: 2 x 4.8x0.8

Width of slot: 7.8 mm

Maximum section of cable: 2 x 2.5 mm²

Fire resistance: EN 60695-2-1, UL94 - V0

Standards: EN 60255, EN 61810



To order

PRDM321	P01 4003 49
PRDM481	P01 4003 50
PRDM801	P01 4003 51



PRDC081 | PRDG161

FOR C & G SERIES RELAYS

CONNECTION
REAR

TERMINAL TYPE
FASTON

MOUNTING
PANEL

PRODUCT ADVANTAGES

- Connection of cable with faston clip
- Panel mounting
- Sturdy construction
- No internal soldering
- Snap-in relay (PRDC081)
- Provision for fitment of retaining clip (PRDG161)
- Provision for fitment of keying pins
- Protection IP10

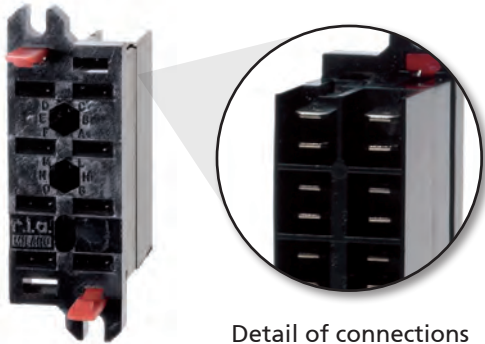

PRDC081

Detail of connections

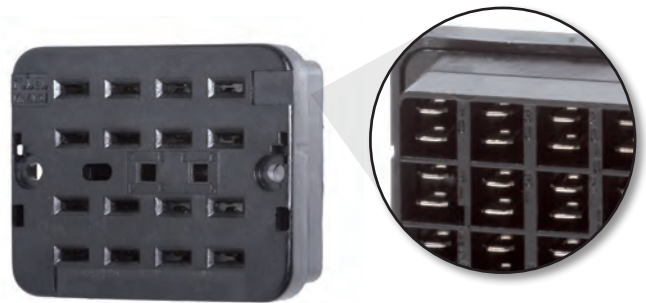

PRDG161

Detail of connections

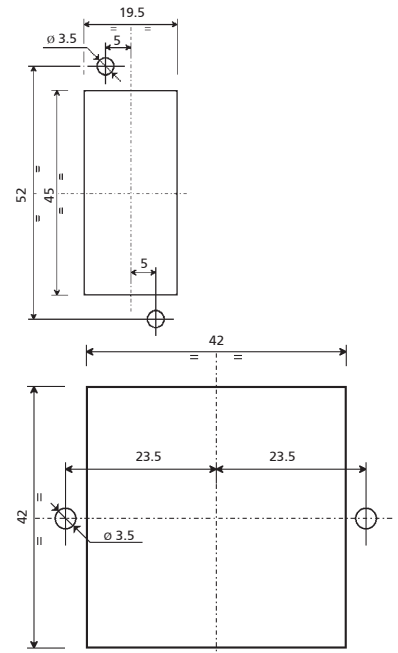
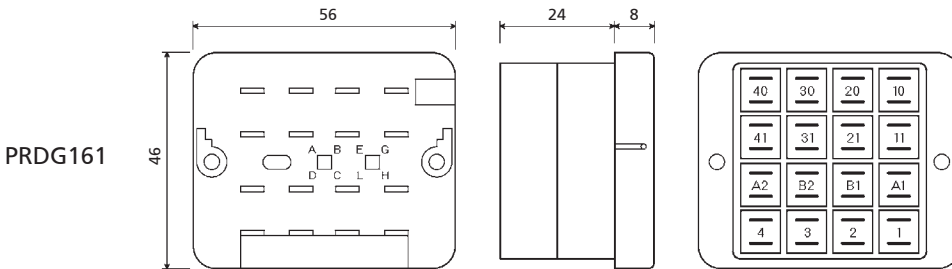
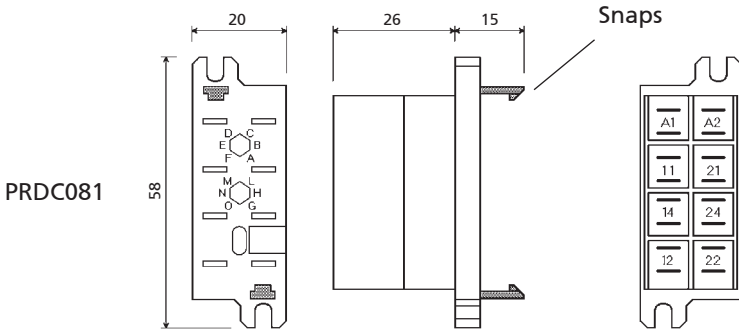

SPECIFICATIONS

Weight: 28 / 69 g
 Operating temperature: -25 °C ... +55 °C
 Storage temperature: -40 °C ... +70 °C
 Panel mounting: • ϕ holes: 3.5 mm
 Degree of protection: IP10
 Dielectric strength: 2.5 kV 50 Hz 1 min

Type and size of faston clip: 2 x 4.8 x 0.8
 Width of slot: PRDC081: 7.3 mm
 PRDG161 : 7.8 mm
 Maximum section of cable: 2 x 2.5 mm²
 Fire resistance: EN 60695-2-1, UL94 - V0
 Standards: EN 60255, EN 60947, EN 61810

To order	
PRDC081	P01 4003 12
PRDG161	P01 4003 20



SOCKETS

REAR CONNECTION (WITH BLADE)

ERL 310

CONNECTION

REAR

TERMINAL TYPE

BLADE

MOUNTING

FLUSH

PRODUCT ADVANTAGES

- Sturdy construction
- No internal soldering

Dimensions

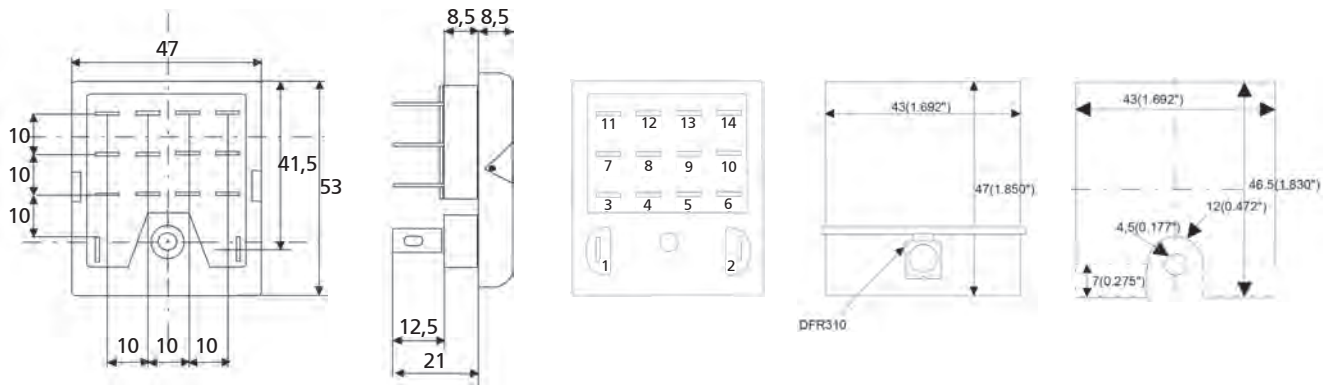

SPECIFICATIONS

Weight: 100 g

To order	
ERL 310	ERLB 4154

For other accessories, see page 201



SOCKETS

REAR CONNECTION (WITH DOUBLE BLADE)

ERL 320

CONNECTION
REAR

TERMINAL TYPE
BLADE

MOUNTING
FLUSH

PRODUCT ADVANTAGES

- Sturdy construction
- No internal soldering

Dimensions

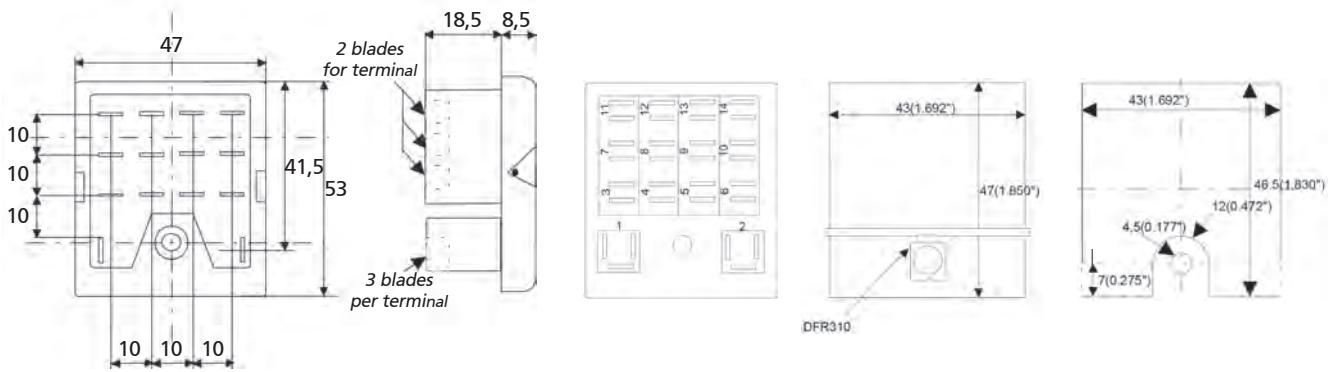

SPECIFICATIONS

To order	
ERL 320	ERLC 4155

Weight: 100 g

ACCESSORIES FOR RE3000 SOCKETS

Retaining clip

Model	Relays	Reference
Clip for short cover (77.5 mm)	RE 3000, RE 3000S, RE 3000N	ACCA 4162

Mounting accessories

Model	Reference
Panel-mounting terminal strip (DFR310)	ACCA 4162
Fitting strap for mounting on bar (DFV310)	ACCA 4162

Mounting accessories

Model	Sockets	Reference
Symmetric DIN rail mounting	EVV 3100, EVL 3100	EVVA 1000
Asymmetric DIN rail mounting	EVV 3100, EVL 3100	EVVA 1001



SOCKET FOR PCG MOUNTING

SOCKETS

PRCC081 | PRCD161

FOR C & D SERIES RELAYS

CONNECTION	TERMINAL TYPE	MOUNTING
REAR	SOLDER	PCB

PRODUCT ADVANTAGES

- PCB-mount
- Panel mounting
- Sturdy construction
- No internal soldering
- No maintenance
- Snap-in relay
- Provision for fitment of keying pins

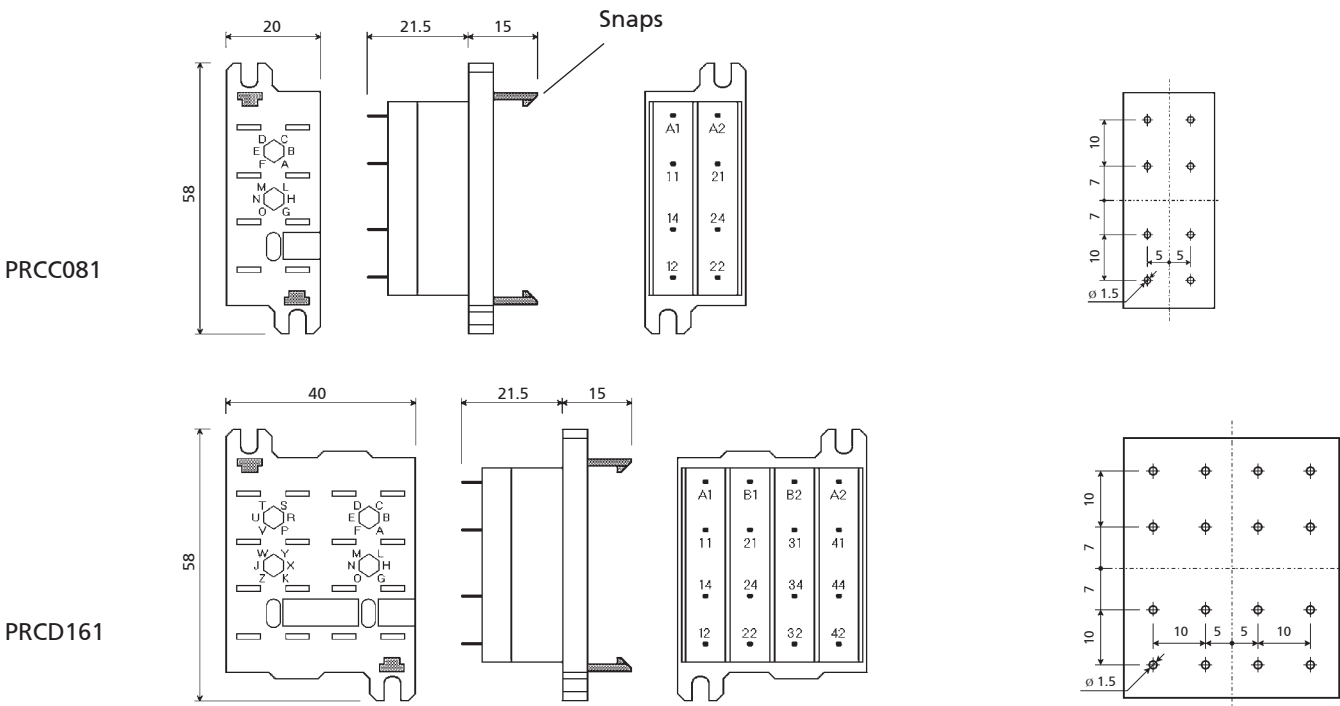
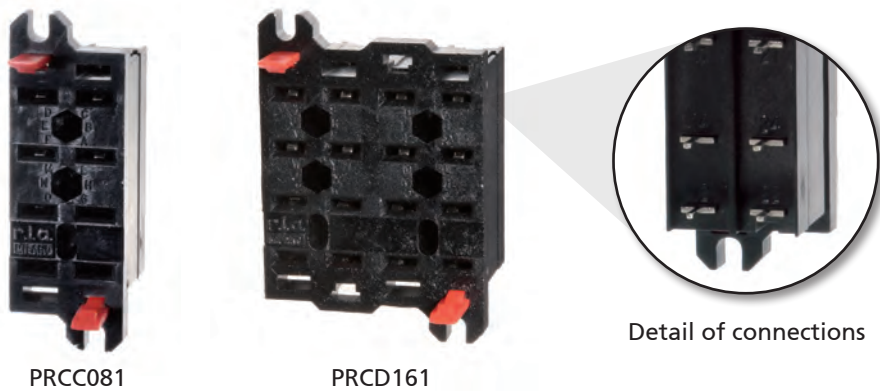

SPECIFICATIONS

Weight: 20 / 36 g
 Operating temperature: -25 °C...+55 °C
 Storage temperature: -40 °C...+70 °C
 Dielectric strength: 2.5 kV 50 Hz 1 min

Type and size of terminals: solder, ϕ 1.5mm
 Fire resistance: EN 60695-2-1, UL94 - V0
 Standards: EN 60255, EN 61810

To order	
PRCC081	P01 4003 15
PRCD161	P01 4003 16



SOCKETS

SOCKET FOR PCB MOUNTING

SOCKET NO. 65

CONNECTION

REAR

TERMINAL TYPE

SOLDER

MOUNTING

PCB

PRODUCT ADVANTAGES

- PCB-mount
- Sturdy construction
- Excellent contact pressure on relay terminals
- No internal soldering
- No maintenance
- Provision for fitment of keying pins
- Provision for fitment of retaining clip

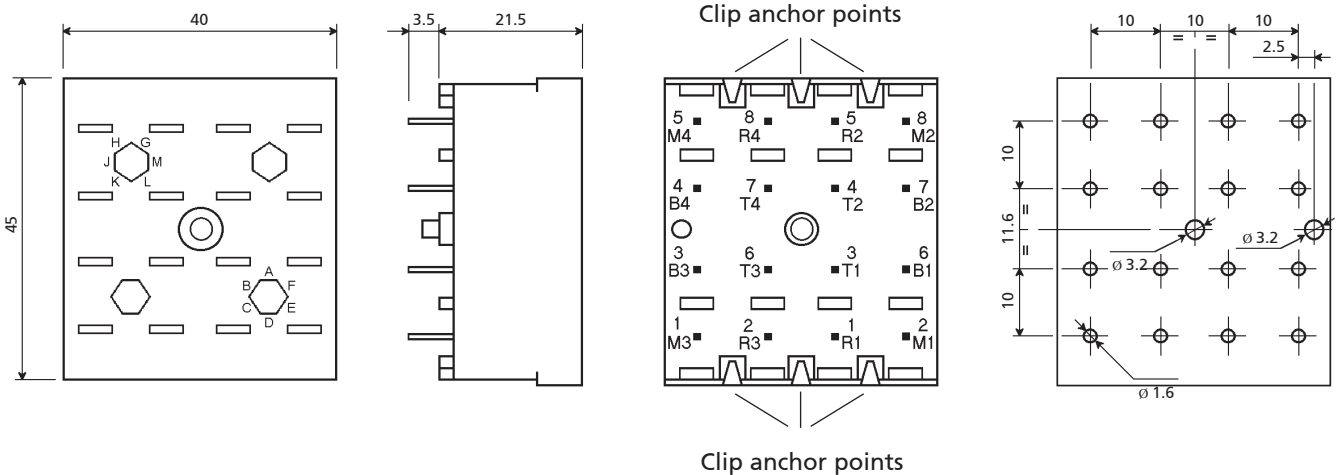

SPECIFICATIONS

Weight: 51 g
 Operating temperature: -25 °C ... +70 °C
 Storage temperature: -40 °C ... +85 °C
 Dielectric strength: 2.5 kV 50 Hz 1 min
 Type and size of terminals: solder, ϕ 1.6mm

Fire resistance: EN 60695-2-1, UL94 - V0,
 EN 45545-2, NFPA130
 Standards: EN 60255, EN 60947, EN 61810,
 EN 61373

To order	
65	P01 4001 53A

INSTANTANÉ
MOA MONOSTABLE
INSTANTANÉOUS
MONOSTABLE

INSTANTANÉOUS
MONOSTABLE WITH
FORCIBLY GUIDED
CONTACTS

BISTABLE

FAST-ACTING
MONOSTABLE
(AND BISTABLE)

TIME DELAY
(ON PICK-UP
OR DROP-OUT)

TIME DELAY WITH
FORCIBLY GUIDED
CONTACTS

MEASUREMENT

SOCKET
NUMBERING
EXPLANATIONS

FRONT
CONNECTION

BACK
CONNECTION

PCB MOUNT

RETAINING CLIPS

KEYING

RETAINING CLIPS
RETAINING CLIPS
RETAINING CLIPS
RETAINING CLIPS
RETAINING CLIPS



RETAINING CLIPS

RETAINING CLIPS

The designation of retaining clips is made up of two parts:

	1 st part: 2 or 3 letters	2 nd part: 2 numbers
	Identifies the type of relay	Identifies the model of socket
Example	RPB	48



1 st part:	Type of relay	2 nd part:	Socket model
RPB	Relays with cover, height 50mm (POKs, UTM series)	43	53IL, 43IL, 73IL, 65
RQ	Relays with cover, height 61mm (QPOK)	48	PAIR, PRIR, 50IP20-I DIN, 48BIP20-I DIN, 78BIP20-I DIN, 96IP20-I DIN, 156IP20-I DIN, 50L, 48BL, 78BL, 96L ADF1, ADF2, ADF3, Series ADF4, ADF6
RG	Relays with cover, height 86mm (RGG series)		
RC	Relays with cover, height 97mm (OK series)		
RL	Relays with cover, height 109mm (OK series)		
RT	Timer relays with cover, height 97mm	31	PAIR, PRIR, 50IP20-I DIN, 48BIP20-I DIN, Series 50L, 48BL, ADF1, ADF2
RM	Relays with cover, height 118mm (MOK series)	41	53IL, 43IL, 65
VM18	Relays RCG, RDG		

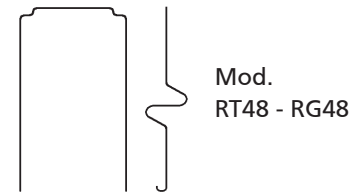
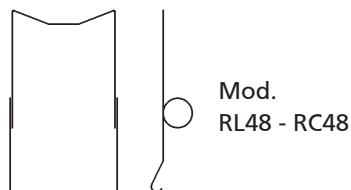
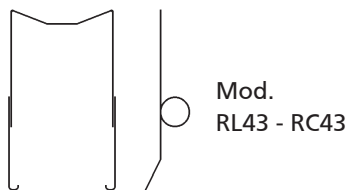
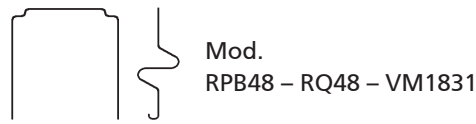

G, C & D LINE RETAINING CLIPS

The designation of retaining clips is made up of two parts:

	1 st part: 4 characters	2 nd part: 2 numbers
	Identifies the line	Identifies the relay size
Example	VM12	21



1 st part:	Relay line	2 nd part:	Relay size
VM12	Relays of G line □ all RGxx models	21	Relays of 82mm height
		22	Relays of 112mm height
VM18	Relays of C and D line □ II RCxx and RDxx models (except RCG, RDG)	21	Relays of 50mm height
		22	Relays of 75mm height
		23	Relays of 82mm height

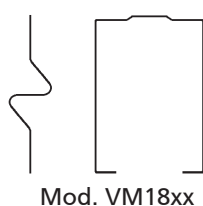
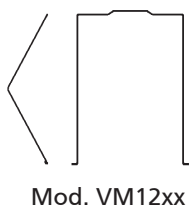

N.B. Dimensions not to scale. The height of the clip varies according to the height of the relay.
Pack containing 10 pieces.



VM12	
VM1221	P01400333
VM1222	P01400334

VM18	
VM1821	P01400330
VM1822	P01400329
VM1823	P01400331

RCG, RDG	
VM1831	P01400335
VM1841	P01400336

RPB	
RPB43	P01400159
RPB48	P01400158
RPB48-UTM	P01400165

RQ	
RQ48	P01400180

RG	
RG43	P01400166
RG48	P01400167

RC	
RC43	P01400161
RC48	P01400179

RL	
RL43	P01400164
RL48	P01400187

RT	
RT43	P01400169
RT48	P01400170

RM	
RM43	P01400133
RM48	P01400134

RMC48	
RMC48	P01400173

MONOSTABLE
INSTANTANEOUS

INSTANTANEOUS
MONOSTABLE WITH
FORCIBLY GUIDED
CONTACTS

BISTABLE

FAST-ACTING
MONOSTABLE
(AND BISTABLE)

TIME DELAY
(ON PICK-UP
OR DROP-OUT)

TIME DELAY WITH
FORCIBLY GUIDED
CONTACTS

MEASUREMENT

SOCKET
NUMBERING
EXPLANATIONS

FRONT
CONNECTION

BACK
CONNECTION

PCB MOUNT

RETAINING CLIPS

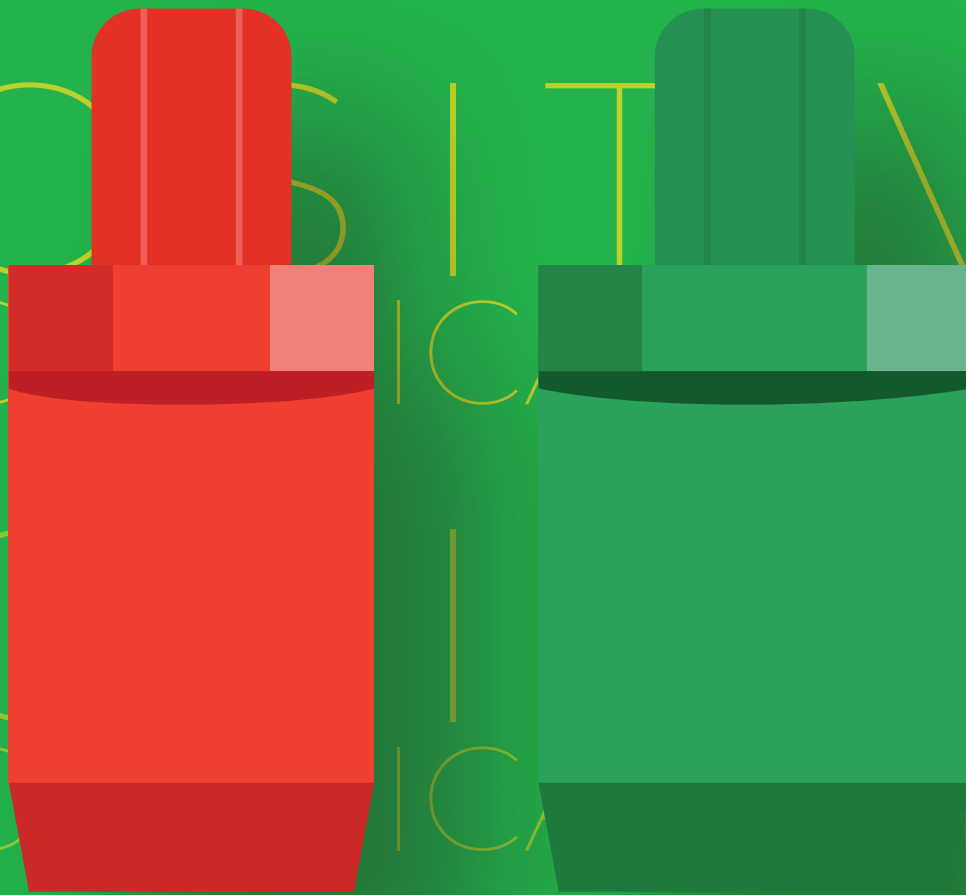

KEYING

POSITIVE MECHANICAL KEYING



POLARIZING PINS

POSITIVE MECHANICAL KEYING (POLARIZING PINS)

Relay line	Ordering code	
OK, POK, RV	59	
Rxx	VC1705	

Keying pins are mechanical components of semi-hexagonal shape, designed to prevent a given relay from being plugged into a socket intended for a different component. The keying configuration is determined by fitting the pins both to the relay and to the socket, in positions identified by a dedicated code.

The hexagonal geometry of the receptacle allows the polarizing pins to be inserted in 6 different positions.

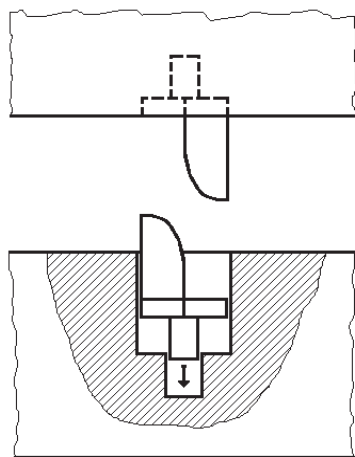

Polarizing pin on relay

Polarizing pin on socket,
to be fitted by the customer

Whilst the use of this component is optional, it is nonetheless strongly recommended where there are multiple relays installed on an electrical panel, for example:

- two or more relays of the same model but with different input voltages
- two or more timer relays with different response and/or logic operating times (e.g. timed to operate on pick-up and timed to operate on drop-out)
- two or more instantaneous relays of different type (e.g. monostable and bistable)

In these cases, the adoption of keying position accessories will prevent any accidental inversion of the relays by the operator, which would risk damage to the system and to the components themselves, as well as jeopardizing safety.

FITMENT AND POSITION

Relays of standard design are not equipped with these accessories.

The mounting position of polarizing pins, if requested, is determined by the manufacturer.

Keying pins for sockets are fitted normally by the customer.

In this case, keying accessories for application to the socket are ordered separately.

The following relays are supplied with pins fitted in positions determined by the manufacturer:

- STATIONS series, approved by ENEL / TERNA Italia to LV15/LV16/20 specifications
- RAILWAYS - FIXED EQUIPMENT series, approved by RFI (FS Italia Group) to RFI DPRIM STF IFS TE 143 A specification
- RAILWAYS - ROLLING STOCK series

POSITIONS OBTAINABLE IN HEXAGONAL RECEPTACLES

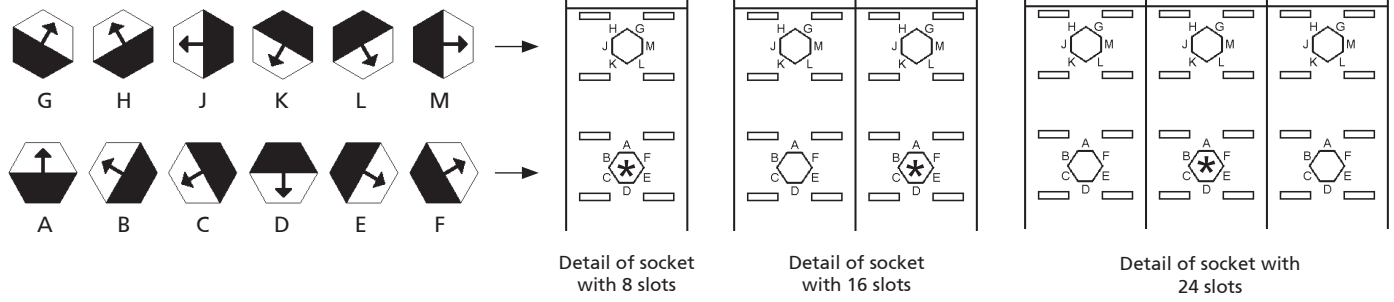

*: receptacle to be left free in the event that the relay is fitted with an antirotation pin.

In the case of polarized input (e.g. with flyback diode), the relay is fitted with an antirotation pin (detail 60). The antirotation pin is always fitted to the following relays: POK, BIPOK, TRIPOK, QUADRIPOK, ESAPOK, TM, OKTx, OKRx, OKRe-L, CLE, OKRe-Fp.

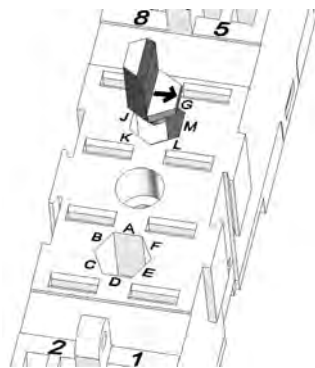

Example of selection, pos. M on socket with 8 slots

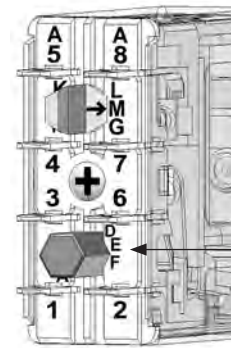

Example of selection, pos. M on POK relay

Antirootation pin

C line

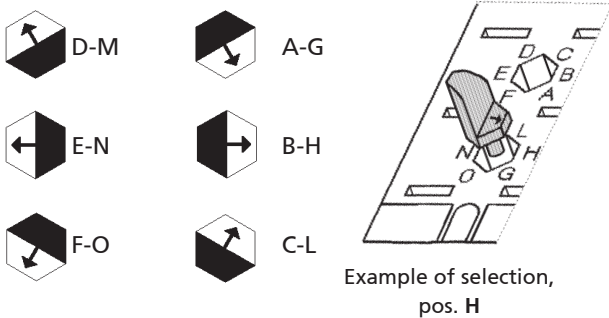

2 hexagonal receptacles available on relay and on socket.

D line

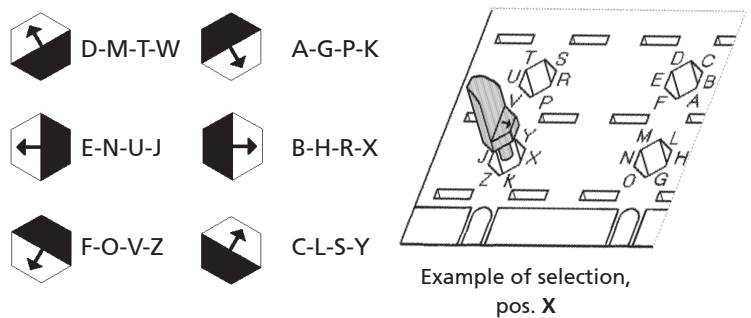

4 hexagonal receptacles available on relay and on socket.

Note: all relays are fitted with an antirotation guide pin.

INSTALLATION

Before installing the relay on a wired socket, disconnect the power supply.

The preferential mounting position is on the wall, with the relay positioned horizontally in the direction of the marking so that the label can be read correctly.

If a relay is used in the “less favorable” conditions including “simultaneously”:

- Power supply: the maximum allowed, permanently
- Ambient temperature: the maximum allowed, permanently
- Current on the contacts: the maximum allowed, permanently
- Number of contacts used: 100%

It is strongly recommended to space the relays at least 5 mm horizontally and 20 mm vertically to allow for proper upward heat dissipation and increase the life expectancy of the component.

In fact, the relays may be used in less harsh conditions. In this case, the distance between adjacent relays can be reduced or eliminated. Correct interpretation of the conditions of use allows optimization of the available space. Please contact Chauvin Arnoux Energy for more information.

To increase relay life expectancy, we recommend mounting relays intended for “continuous use” (permanent power supply), alternating them with relays intended for less frequent use.

For safe use, the use of retaining clips is recommended. For use on rolling stock, the relays have been tested according to the EN 61373 standard when equipped with retaining clip(s).

OPERATION

Before use : if the relay is used after long storage periods, for example, contact resistance may increase due to slight natural oxidation or polluting deposits.

In order to restore the optimum conductivity for standard contacts (NOT gold plated), it is recommended to switch a load of at least 110Vdc - 100mA or 24Vdc - 500mA several times. The contacts will thus be “cleaned” by the electric arc generated during the current interruption and the mechanical self-cleaning action.

The common contact rubs against the fixed poles (NO and NC contacts) both when opening and when closing, thus ensuring self-cleaning.

In most cases, a higher contact resistance is not a problem. Many factors contribute to the correct use of the contacts and consequently to the relays’ long-term reliability:

- **Load:** the current switching generates an electric arc with cleaning effects. To ensure proper electrical cleaning and maintain performance levels, we recommend:
 - o Standard contacts: Minimum current = 20mA
 - o Gold plated contacts: Minimum current = 10mA
- **Operating frequency:** relays are components which can operate with a wide range of switching frequencies. High frequency operation also allows a continuous cleaning effect by “sliding” (mechanical cleaning). In the event of low frequency operation (for example few times a day), we advise:
 - o Use of contact with currents twice those indicated.
 - o For currents lower than 10mA, use gold plated contacts and connect 2 contacts in parallel, in order to reduce the equivalent contact resistance
- **Pollution:** the presence of pollution can cause impurities on the surface of the contacts. Electric charges attract organic molecules and impurities which are deposited on the contact surface. Electrical and mechanical cleaning, respectively, burn off and remove such impurities. In the presence of pollution, the minimum recommended currents must be respected. In extreme cases, provide double the cleaning current.

Condensation is possible inside the relay when energized and the outside ambient temperature is cold; this is quite normal and does not affect the operation of the relay. The plastic materials of the relay do not possess hygroscopic properties.

MAINTENANCE

No maintenance is required.

In the event of normal relay wear (electrical or mechanical end-of-life), the relay cannot be restored and must be replaced.

To check the component, relay removal must be carried out with slight lateral movements. An “up and down” movement can cause damage the terminals. For RMMV11 / RMMV17 removal, please read the product instructions.

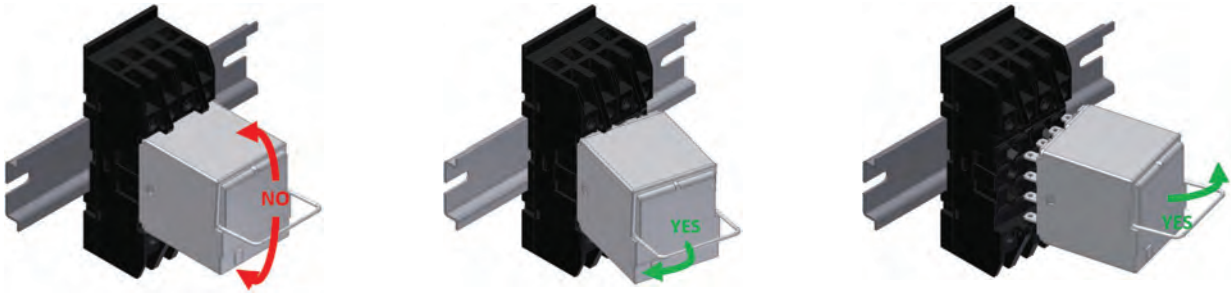

Malfunctions are often caused by a power supply with inverted polarity, by external events or by use with loads exceeding the contact performance.

In case of suspected malfunction, energize the relay and observe if mechanical operation of the contacts / relay mechanism is performed. Check the power supply polarity if relay is equipped with polarized components (example: diode, LED).

- If you plan to use the relay, clean the contacts (see paragraph on “OPERATION”) and check if the circuit load corresponds to the contact specifications. If necessary, replace with relays with gold-plated contacts. Note: the electrical continuity of contacts must be checked with adequate current.
- If it does not work, we recommend to use a relay of the same model and configuration.

If an investigation by Chauvin Arnoux Energy is required, pull-out the relay from the socket without removing the cap, avoid any other manipulation and contact us. You will be asked for the following data: environmental conditions, power supply, switching frequency, contact load, number of operations performed.

The fault can be described through the “TECHNICAL SUPPORT” section of the website www.chauvin-arnoux-energy.com/fr/support. The relay cannot be repaired by the user under any circumstances.

STORAGE

The storage conditions must guarantee the environmental conditions (temperature, humidity and pollution) required for product conservation in order to avoid deterioration.

The product must be stored in an environment which is sheltered from atmospheric agents and pollution-free, with an ambient temperature between -40 and + 85 ° C and 80% RH max. Humidity may reach peaks of 95%. Whatever the case, there must be no condensation. Before use, please read the “OPERATION” section carefully.